

# clarion®

## **Owner's manual**

使用说明书

사용 설명서

# ***VXZ766***

---

**DVD/CD/MP3/WMA Receiver/CeNET Control**

DVD/CD/MP3/WMA接收器/ CeNET控制

DVD/CD/MP3/WMA 리시버/CeNET 컨트롤

Thank you for purchasing this **Clarion** product.

- Please read this owner's manual in its entirety before operating this equipment.
- After reading this manual, be sure to keep it in a handy place (e.g., glove compartment).
- This manual includes the operating procedures of the CD changer and TV tuner connected via the CeNET cable. The CD changer and TV tuner have their own manuals, but no explanations for operating them are described.

## Contents

<b>1. FEATURES</b> .....	<b>2</b>
<b>2. PRECAUTIONS</b> .....	<b>3</b>
Flip Down Panel .....	4
Handling Compact Discs .....	4
<b>3. CONTROLS</b> .....	<b>5</b>
<b>4. NOMENCLATURE</b> .....	<b>6</b>
Names of the Buttons and their Functions .....	6
Major Button Operations When External Equipment is Connected to This Unit .....	7
Display Items .....	8
Display Screen .....	8
<b>5. DCP</b> .....	<b>9</b>
<b>6. DVD VIDEO SYSTEM</b> .....	<b>10</b>
<b>7. REMOTE CONTROL</b> .....	<b>12</b>
Buttons Used in the DVD Mode (During DVD/VCD playback) .....	13
Buttons Used in Other Modes .....	14
Operation Range of the Remote Control Unit .....	15
Inserting the Batteries .....	15
<b>8. OPERATIONS</b> .....	<b>16</b>
Basic Operations .....	16
Radio Operations .....	19
DVD Operations .....	21
Watching a DVD-Video .....	22
Watching a video CD (V-CD) .....	24
Listening to a CD .....	26
Listening to an MP3/WMA .....	27
Changing Initial Settings such as Menu Language, etc. ....	30
Different Pieces of Music Heard by Plural Listeners (2-ZONE function) .....	39
Common Operations .....	40
<b>9. OPERATIONS OF ACCESSORIES</b> .....	<b>44</b>
CD Changer Operations .....	44
TV Operations .....	46
<b>10. TROUBLE SHOOTING</b> .....	<b>48</b>
<b>11. ERROR DISPLAYS</b> .....	<b>49</b>
<b>12. SPECIFICATIONS</b> .....	<b>50</b>

## 1. FEATURES



- 2-Zone: Front and rear separate entertainment
- Built-in 5.1 channel surround system: Dolby Pro Logic/Dolby Digital AC3/DTS decoder
- VF display & Flip-down console

## 2. PRECAUTIONS

1. When the inside of the car is very cold and the player is used soon after switching on the heater moisture may form on the disc or the optical parts of the player and proper playback may not be possible. If moisture forms on the disc, wipe it off with a soft cloth. If moisture forms on the optical parts of the player, do not use the player for about one hour. The condensation will disappear naturally allowing normal operation.
2. Driving on extremely bumpy roads which cause severe vibration may cause the sound to skip.
3. This unit uses a precision mechanism. Even in the event that trouble arises, never open the case, disassemble the unit, or lubricate the rotating parts.

### **⚠ CAUTION**

**USE OF CONTROLS, ADJUSTMENTS, OR PERFORMANCE OF PROCEDURES OTHER THAN THOSE SPECIFIED HEREIN, MAY RESULT IN HAZARDOUS RADIATION EXPOSURE.**

**THE COMPACT DISC PLAYER and MINI DISC PLAYER SHOULD NOT BE ADJUSTED OR REPAIRED BY ANYONE EXCEPT PROPERLY QUALIFIED SERVICE PERSONNEL. CHANGES OR MODIFICATIONS NOT EXPRESSLY APPROVED BY THE MANUFACTURER FOR COMPLIANCE COULD VOID THE USER'S AUTHORITY TO OPERATE THE EQUIPMENT.**

### **INFORMATION FOR USERS:**

**CHANGES OR MODIFICATIONS TO THIS PRODUCT NOT APPROVED BY THE MANUFACTURER WILL VOID THE WARRANTY.**

## Flip Down Panel

This unit uses a flip-down structure that makes possible large-size displays.



### CAUTION

**When opening and closing the FLIP DOWN PANEL, be careful not to catch your fingers. They could be injured.**

1. Always use this unit with the FLIP DOWN PANEL closed.

2. Do not force operations or use this device abnormally when opening or closing the FLIP DOWN PANEL.
3. Do not use the FLIP DOWN PANEL as a tray to place objects on when it is open.
4. When closing the FLIP DOWN PANEL, do not press the [OPEN] button.
5. Strong impacts to the operating or display section can cause damage or deformation.
6. If the FLIP DOWN PANEL does not open fully, gently open it with your hand.

## Handling Compact Discs

Use only compact discs bearing the  or  mark.

Do not play heart-shaped, octagonal, or other specially shaped compact discs.

Some CDs recorded in CD-R/CD-RW mode may not be usable.

- To remove a compact disc from its storage case, press down on the center of the case and lift the disc out, holding it carefully by the edges.
- Do not use commercially available CD protection sheets or discs equipped with stabilizers, etc. These may damage the disc or cause breakdown of the internal mechanism.

### Handling

- Compared to ordinary music CDs, CD-R and CD-RW discs are both easily affected by high temperature and humidity and some of CD-R and CD-RW discs may not be played. Therefore, do not leave them for a long time in the car.
- New discs may have some roughness around the edges. If such discs are used, the player may not work or the sound may skip. Use a ball-point pen or the like to remove any roughness from the edge of the disc.

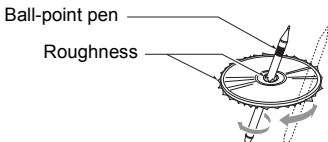

- Never stick labels on the surface of the compact disc or mark the surface with a pencil or pen.
- Never play a compact disc with any cellophane tape or other glue on it or with peeling off marks. If you try to play such a compact disc, you may not be able to get it back out of the CD player or it may damage the CD player.
- Do not use compact discs that have large scratches, are misshapen, cracked, etc. Use of such discs may cause misoperation or damage.

### Storage

- Do not expose compact discs to direct sunlight or any heat source.
- Do not expose compact discs to excess humidity or dust.
- Do not expose compact discs to direct heat from heaters.

### Cleaning

- To remove fingerprints and dust, use a soft cloth and wipe in a straight line from the center of the compact disc to the circumference.
- Do not use any solvents, such as commercially available cleaners, anti-static spray, or thinner to clean compact discs.
- After using special compact disc cleaner, let the compact disc dry off well before playing it.

### WARNING

#### About a Single CD (8cm CD)

- **Since the unit is not compatible with a single CD, do not load it into the unit.**
- **Keep in mind the fact that a single CD cannot be played even using a single CD adaptor for the unit.**
- **If you try to push it into the unit forcibly without removing it, the CD cannot be ejected. This will result in damage to the mechanism. Please never do this.**

**Be sure to unfold and read the next page. /**

**务必打开并阅读下一页。 /**

**이 페이지를 펼친 채로 다음 페이지를 읽어 주십시오.**

# 3. CONTROLS / 控制键 / 컨트롤

Source unit / 主机 / 본체

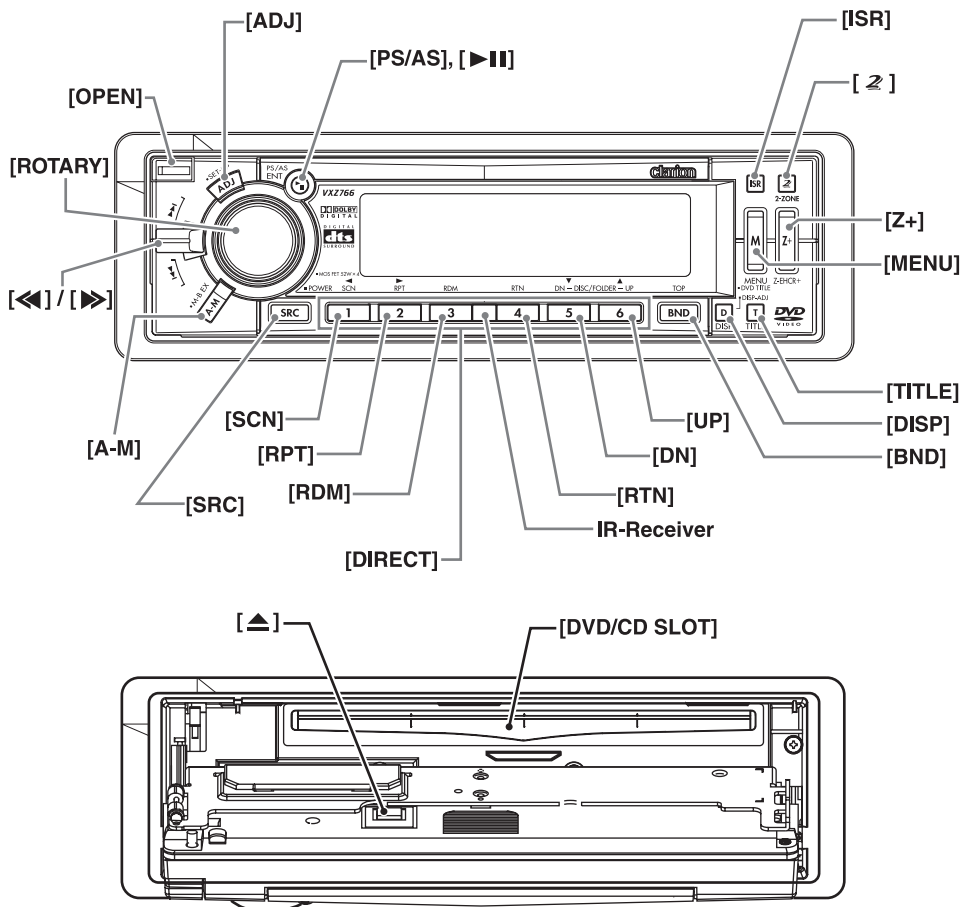

**Note:** Be sure to unfold this page and refer to the front diagrams as you read each chapter.

注: 请务必打开此页, 并在阅读每一章节时参照上面的正视图。

주: 이 페이지를 펼쳐두고, 각 장을 읽을 때 전면 그림을 참조하십시오.

# 4. NOMENCLATURE

## Note:

- Be sure to read this chapter referring to the front diagrams of chapter "3. CONTROLS" on page 5 (unfold).

## Names of the Buttons and their Functions

### [OPEN] button

- Deeply push in the button to unlock the flip down panel.

### [ADJ] button

- Switches to the adjust mode.
- Press and hold for 1 second or longer to display the setup main menu while in the DVD mode.

### [PS/AS], [▶||] button

- Plays or pauses a CD or DVD while in the DVD mode.
- Press and hold for 1 second or longer in the DVD mode to stop playback.
- Performs preset scan in the radio mode.
- Press and hold for 2 seconds or longer to perform auto store in the radio mode.
- Confirms various settings.

### [ISR] button (Instant station recall)

- Recalls ISR radio station in memory.
- Press and hold for 2 seconds or longer: Stores current station into ISR memory (radio mode only).

### [Z] button

- Press and hold for 1 second or longer to turn on or off the 2-ZONE mode.
- Press to switch the control zone between main zone or sub zone while 2-ZONE mode on.

### [Z+] button

- Use the button to select one of the 4 types of sound characteristics already stored in memory.
- Press and hold for 1 second or longer to return to "FLAT" the default value.

### [MENU] button

- The DVD menu is displayed while a DVD is playing.
- Pressing and holding for 1 second or longer also displays the DVD title screen.
- The VCD MENU is displayed while a Video CD is playing (when PBC is ON).

### [TITLE] button

- Switches the titles.
- Press and hold for 1 second or longer to input or scroll the title.

### [DISP] button

- Switches the display indication (main display, clock display).
- Press and hold for 1 second or more but less than 4 seconds to switch to the display adjust mode.
- Press and hold for 4 seconds or longer to turn off the display.

### [BND] button

- Switches the band.
- Press and hold for 1 second or longer to switch seek or manual tuning.
- Returns to a first scene or track while in the DVD mode.

### [UP], [DN] buttons

- Selects the folder while an MP3/WMA disc is playing.

### IR-Receiver

- Receiver for remote control unit. (Operating range: 30° in all directions)

### [DIRECT] buttons

- Stores a station into memory or recalls it directly while in the radio mode.

### [RDM] button

- Performs random play while in the DVD mode.
- Press and hold for 1 second or longer to perform folder random play while an MP3/ WMA disc is playing.

### [RPT] button

- Repeats play while in the DVD mode.
- Press and hold for 1 second or longer to perform folder repeat play while an MP3/ WMA disc is playing.

### [SCN] button

- Performs scan play for 10 seconds of each track while in the DVD mode.
- Press and hold for 1 second or longer to perform folder scan play while an MP3/WMA disc is playing.

### [SRC] button

- Press to turn on the power.
- Press and hold for 1 second or longer to turn off the power.
- Switches the operation mode among the radio mode, etc.

**[A-M] button**

- Switches to the audio mode (CENTER-VOL., SUB-WOOF VOL., Z-Enhancer Plus, BASS, TREBLE, BALANCE, FADER).
- Press and hold for 1 second or longer to turn on or off the MAGNA BASS EXTENDED.

**[◀◀] / [▶▶] lever**

- Select a station while in the radio mode or select a scene or a track while in the DVD mode.
- This lever is used to make various settings.
- Move for 1 second or longer to switch the fast-forward/fast-rewind.

**[ROTARY] knob**

- Turn to adjust the volume.
- Performs various settings.

**[DVD/CD SLOT]**

- Disc insertion slot.

**[▲] button**

- Ejects a disc loaded in the unit.

## Major Button Operations When External Equipment is Connected to This Unit

**●When the CD changer is connected**

- For details, see the section “CD Changer Operations” (P. 44).

**[▶▶▶] button**

- Plays or pauses a CD.

**[TITLE] button**

- Switches the titles.
- Press and hold for 1 second or longer to input or scroll the title.

**[DISP] button**

- Switches the display indication (main display, clock display).
- Press and hold for 1 second or more but less than 4 seconds to switch to the display adjust mode.
- Press and hold for 4 seconds or longer to turn off the display.

**[BND] button**

- Advances to next disc.

**[UP], [DN] buttons**

- Selects the disc.

**[RDM] button**

- Performs random play.
- Press and hold for 1 second or longer to perform disc random play.

**[RPT] button**

- Performs repeat play.
- Press and hold for 1 second or longer to perform disc repeat play.

**[SCN] button**

- Performs scan play for 10 seconds of each track.
- Press and hold for 1 second or longer to perform disc scan play.

**[◀◀] / [▶▶] lever**

- Repeats or advances a track when listening to a disc.
- Move for 1 second or longer to switch the fast-forward/fast-rewind.

**●When the TV is connected**

- For details, see the section “TV Operations” (P. 46).

**[ADJ] button**

- Press and hold for 1 second or longer to switch the TV picture mode or VTR (external) picture mode.

**[PS/AS] button**

- Performs preset scan in the TV mode.
- Press and hold for 2 seconds or longer to perform auto store in the TV mode.

**[BND] button**

- Switches the band.
- Press and hold for 1 second or longer to switch seek or manual tuning.

**[DIRECT] buttons**

- Stores a station into memory or recalls it directly.

**[◀◀] / [▶▶] lever**

- Selects a station.

# Display Items

Operation status and function mode indication  
Titles, Clock, and the names of the mode being  
selected etc. are displayed.

2 : 2-ZONE indication  
MAIN : Main indication  
SUB : Sub indication

ALL : Disc (folder) Scan etc.  
SCN : Scan indication  
RPT : Repeat indication  
RDM : Random indication



Function indication

“ST” : Stereo indication  
MANU : Manual indication  
MP3 : MP3 indication  
WMA : WMA indication  
DVD : DVD indication  
VCD : VCD indication  
ENT : ENT indication

MAGNA BASS EXTEND indication  
Z ENHANCER+ : Z-Enhancer Plus indication  
MUTE indication

Playback time indication,  
Frequency indication

Reception band indication  
Track number indication (CD/V-CD/MP3/WMA disc)  
Chapter number indication (DVD disc)  
Preset channel indication (1 to 6)  
Disc number indication (1 to 6) (CD)  
Title number indication (DVD disc)  
Folder number indication (MP3/WMA disc)

# Display Screen

In extreme cold, the screen moves and the screen may darken, but this is normal.  
The screen will recover when it returns to normal temperature.

The color of the display screen may change due to the temperature inside your car. This is the  
phenomenon specific to illuminant. The screen will recover when it returns to normal temperature.



# 5. DCP

The control panel can be detached to prevent theft. When detaching the control panel, store it in the DCP (DETACHABLE CONTROL PANEL) case to prevent scratches.

We recommend taking the DCP with you when leaving the car.

## Removing the DCP

1. Press the [SRC] button for 1 second or longer to turn off the power.
2. Deeply push in [OPEN] button to unlock the flip down panel.
- If the flip down panel does not open fully, gently open it with your hand.

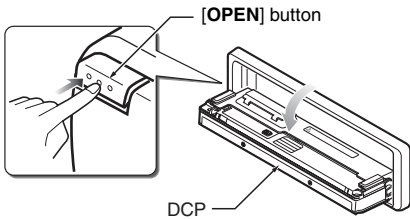

3. Pull the DCP toward you and remove it.

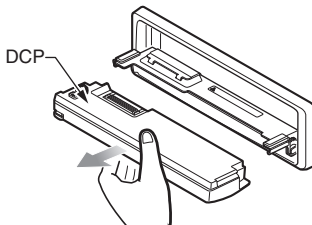

4. Close the HOLD FLAP.

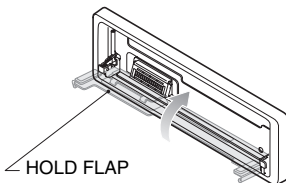

## CAUTION

Be sure to close the HOLD FLAP for safety when removing the DCP.

## Attaching the DCP

1. Insert the right side of the DCP into the main unit.
2. Insert the left side of the DCP into the main unit.

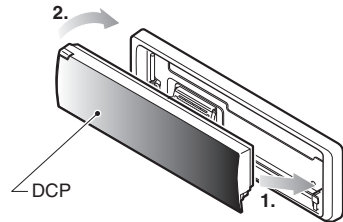

## CAUTION

- The DCP can easily be damaged by shocks. After removing it, be careful not to drop it or subject it to strong shocks.
- If the FLIP DOWN PANEL is kept open, the DCP may drop due to vibration of the car. This results in damage to the DCP. So close the FLIP DOWN PANEL or remove the DCP to store into the case.
- The connector connecting the source unit and the DCP is an extremely important part. Be careful not to damage it by pressing on it with fingernails, screwdrivers, etc.

### Note:

- If the DCP is dirty, wipe off the dirt with a soft, dry cloth only.

# 6. DVD VIDEO SYSTEM

DVD video is a high-quality digital video source that provides crisp and clear images. One 12 cm disc contains either one film or four hours of music.

## ●DVD Video Features

This unit provides the following functions in addition to the high image quality and sound quality of DVD video.

### Notes:

- The functions, for example, the recorded language, subtitles, angles, etc. differ with the DVD video disc. Refer to the instructions provided with the DVD video.
- Some disc functions may operate differently than described in this manual.

## ●Note on region numbers

The DVD video system assigns a region number to DVD video players and DVD discs by sales area.

This player can play "ALL" and "3" or "4" (and those inclusive). For information checking on the recognition of "3" and "4", see "**Country code list**" (P. 33). The DVD video region number is marked on the disc jacket as shown.



## ●Multi-sound function

DVD video can store up to 8 languages for one film; select the language of your preference.

- The languages stored on the disc are indicated by the icon as shown.



## ●Multi-angle function

A DVD video that is filmed from multiple angles allows you to select the angle of choice.

- The number of recorded angles are indicated by the icon as shown.



## ●Subpicture (subtitles) function

A DVD video can record subtitles for up to 32 languages and you can select the language of the subtitles you wish to see.

- The number of recorded subtitle languages are indicated by the icon as shown.



## ●Multi-story function

When a DVD video contains more than one story for a film, you can select the story you wish to enjoy. The operation procedures vary with the disc; observe the instructions for selecting a story provided during playback.

## ●Dolby Digital

Dolby Digital enables up to 5.1 independent multi-channel audio reproduction, the same type of surround system that is also used in movie theaters.



## ●DTS

DTS (Digital Theater System) is a sound system that differs from the Dolby Digital system. DTS provides a larger amount of data than Dolby Digital enabling high-quality surround playback and incorporates a DTS-CD software for music like a DVD software allows 5.1 channel independent multichannel audio reproduction.



## ●Menu screens

Menus can be called up during DVD video playback to perform menu setting.

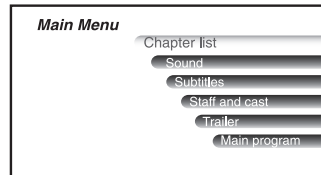

## ●TV color system

This DVD player plays PAL discs and NTSC discs only and cannot be used for playback of SECAM discs.

## ● Playable discs

This DVD video player can play the following discs.

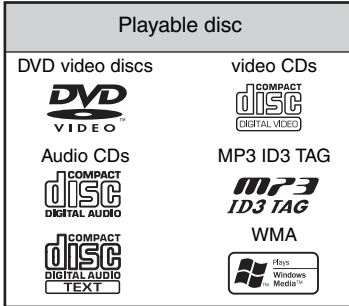

## ● MP3/WMA discs

This unit can play back CD-R/CD-RW and DVD±R/RW discs on which MP3/WMA music data have been recorded. For a detailed information, see the page entitled “**Listening to an MP3/WMA**” (P. 27).

## ● CD Extra discs

A CD Extra disc is a disc in which a total of two sessions have been recorded. The first session is Audio session and the second session Data session.

Your personally-created CDs with more than second data sessions recorded cannot be played on this DVD video player.

### Note:

- When you play a CD Extra disc, only the first session will be recognized.

## ● Discs that cannot be played back

This DVD video player cannot play back DVD-Audio, DVD-RAM, Photo CDs, etc.

### Notes:

- This unit cannot play 8cm discs.
- It may also not be possible to play back CDs recorded on a CD-R unit and CD-RW unit. (Cause: disc characteristics, cracks, dust/dirt, dust/dirt on player's lens, etc.)
- If a CD-R or CD-RW disc that has not been finalized is played, it will take a long time to start playing. Also, it may not be possible to play depending on its recording conditions.
- You cannot play Super Audio CDs. Playback of the CD layer is not supported even if it is a hybrid disc.

## ● About playing a CD-R/CD-RW disc (MP3, WMA)

This player can play CD-R/CD-RW discs previously recorded in music CD format (MP3, WMA) or video CD format.

## ● About playing a DVD±R/RW disc

This player cannot play DVD±R/RW discs previously recorded in video CD format. However, MP3/WMA files recorded on DVD±R/RW discs can be played.

## About the registered marks etc.

- This product incorporates copyright protection technology that is protected by method claims of certain U.S. patents and other intellectual property rights owned by Macrovision Corporation and other rights owners. Use of this copyright protection technology must be authorized by Macrovision Corporation, and is intended for home and other limited viewing uses only unless otherwise authorized by Macrovision Corporation. Reverse engineering or disassembly is prohibited.
- Manufactured under license from Dolby Laboratories. “Dolby”, “Pro Logic”, and the double-D symbol are trademarks of Dolby Laboratories.
- Manufactured under license from Digital Theater Systems, Inc. U.S. Pat. No's. 5,451,942; 5,956,674; 5,974,380; 5,978,762; 6,226,616; 6,487,535 and other U.S. and worldwide patents issued and pending. “DTS” and “DTS Digital Surround” are registered trademarks of Digital Theater Systems, Inc. Copyright 1996, 2003 Digital Theater Systems, Inc. All Rights Reserved.
- Windows Media™, and the Windows® logo are trademarks, or registered trademarks of Microsoft Corporation in the United States and/or other countries.

# 7. REMOTE CONTROL

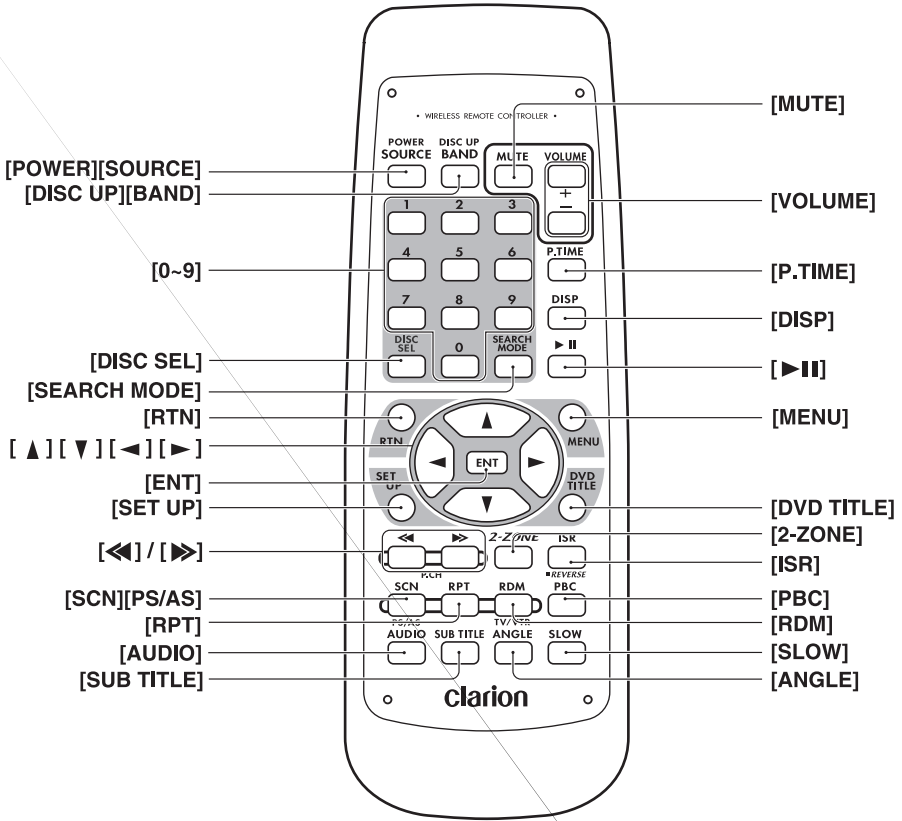

## Buttons Used in the DVD Mode (During DVD/VCD playback)

### [P.TIME] button

Used to switch among play time displays.

### [0-9] buttons (Ten-key buttons)

Used to input numbers.

### [MENU] button

**DVD VIDEO:** Displays the menu screen.

**V-CD:** Displays the PBC menu.

### [RTN] button

Returns to the previous menu.

### [◀], [▶], [▲], [▼] buttons (cursor buttons)

When selecting the menu items shown in the monitor screen, use the cursor buttons to move the cursor up and down, left and right.

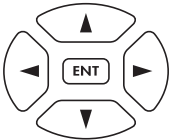

### [ENT] button

Press this button to enter the setup item.

### [DVD TITLE] button

**DVD VIDEO:** Displays the title screen.

### [SET UP] button

Displays the setup screen of the unit.

### [PBC] button

Turns on/off the playback control (PBC) function.

### [AUDIO] button

**DVD VIDEO:** Switches among languages for audio.

**V-CD:** Switches among audio output methods.

### [SUB TITLE] button

Switches among languages for the subtitle.

### [ANGLE] button

Switches among angles while in DVD playback. (This button is available only on multiple angles DVDs.)

### [SLOW] button

While the button is kept pressed, slow play is performed.

### [SEARCH MODE] button

After this button is pressed, enter numbers using Ten-key buttons.

**DVD-VIDEO:** TITLE/CHAPTER number.

**V-CD:** TRACK number (key inputs are accepted only when the PBC is turned off.)

**CD:** TRACK number.

**MP3/WMA:** FOLDER/TRACK number.

### [RPT] button

Repeat play. (During DVD-video playback.)

- Scan/repeat/random playback is impossible during VCD playback.

## Buttons Used in Other Modes

Mode Button	Radio	DVD	CD changer	TV
[SRC]	Switches among radio, DVD, CD changer, TV and AUX.			
[DISC UP], [BND]	Switches reception band.	Returns to the first track.	Moves the next disc in increasing order.	Switches reception band.
[VOLUME]	Increases and decreases volume (in all modes).			
[◀], [▶]	Moves preset channels up and down.	Moves tracks up and down. When pressed and held for 1 second or longer: Fast-forward/fast-rewind.		Moves preset channels up and down.
[▶  ]	No function.	Switches between playback and pause. When pressed and held for 1 second or longer to stop play.	Switches between playback and pause.	No function.
[MUTE]	Turns mute on and off.			
[ISR]	Recalls ISR radio station in memory. When pressed and held for 2 seconds or longer: Stores current station into ISR memory (radio mode only).			
[DISP]	Switches among main display and clock display, and turns off the display. When pressed and held for 1 second or longer: Switches the titles (except in the TV mode).			
[SCN], [PS/AS]	Preset scan. When pressed and held for 2 seconds or longer: Auto store.	Scan play. When pressed and held for 1 second or longer: Folder scan play (MP3/WMA disc).	Scan play. When pressed and held for 1 second or longer: Disc scan play.	Preset scan. When pressed and held for 2 seconds or longer: Auto store.
[RPT]	No function.	Repeat play. When pressed and held for 1 second or longer: Folder repeat play (MP3/WMA disc).	Repeat play. When pressed and held for 1 second or longer: Disc repeat play.	No function.
[RDM]	No function.	Random play. When pressed and held for 1 second or longer: Folder random play (MP3/WMA disc).	Random play. When pressed and held for 1 second or longer: Disc random play.	Switches between TV and VTR.
[2-ZONE]	Press to switch the control zone between main zone or sub zone while 2-ZONE mode on. Press and hold for 1 second or longer to turn on or off the 2-ZONE mode.			

- Some of the corresponding buttons on the source unit and remote control unit have different functions.
- The [DISC SEL] button and the [REVERSE] button cannot be used for this unit.

## Operation Range of the Remote Control Unit

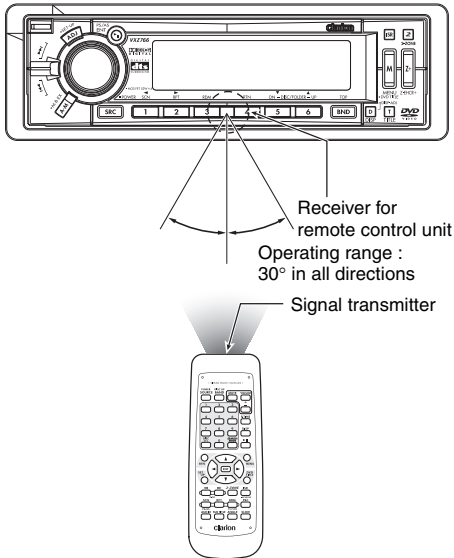

## Inserting the Batteries

1. Open the rear battery cover.

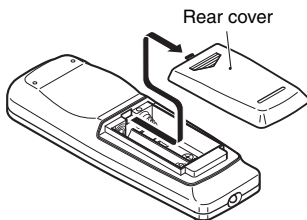

2. Insert the two supplied size AA (SUM-3, R6/1.5V) batteries orienting the plus and minus poles of the batteries as shown by the <+> and <-> symbols inside the battery compartment. Close the battery cover.

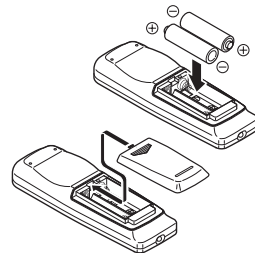

### Notes:

Using batteries improperly can cause them to explode. Take note of the following points:

- When replacing batteries, replace both batteries with new ones.
- Do not short-circuit, disassemble or heat batteries.
- Do not dispose of batteries into fire or flames.
- Dispose of spent batteries properly.

# 8. OPERATIONS

## Basic Operations

### Note:

- Be sure to read this chapter referring to the front diagrams of chapter “3. CONTROLS” on page 5 (unfold).

### CAUTION

**Be sure to lower the volume before switching off the unit power or the ignition key. The unit remembers its last volume setting. If you switch the power off with the volume up, when you switch the power back on, the sudden loud volume may hurt your hearing and damage the unit.**

### System check and speaker setting

During the initial power up of this unit, it will go through a system check procedure.

This procedure verifies any devices connected through CeNET. Any additional CeNET devices plugged into the unit after the initial power up will initiate the system check procedure.

1. When the power is turned on, “SYSTEM” appears in the display if the wire connections were modified.

The system check starts automatically within the unit.

2. When the system check is complete, “SP-SET” appears in the display. Perform the speaker setting.
3. Turn the [ROTARY] knob to select the speaker system.

- The factory default setting is “2ch”. (Adjustment 2ch/5.1ch)
- To enjoy 5.1ch surround sound more effectively, we recommend equipment of the center speaker and the sub-woofer.

4. Press the [▶||] button.

- The setting is complete and the display switches to the radio mode.

### Turning on/off the power

#### Note:

- Be careful about using this unit for a long time without running the engine. If you drain the car’s battery too far, you may not be able to start the engine and this can reduce the service life of the battery.

1. Press the [SRC] button.

2. The illumination and display on the unit light up. The unit automatically remembers its last operation mode and will automatically switch to display that mode.
3. Press and hold the [SRC] button for 1 second or longer to turn off the power for the unit.

### Selecting a mode

1. Press the [SRC] button to change the operation source mode.
2. Each time you press the [SRC] button, the operation mode changes in the following order:

**Radio mode → DVD mode → (CD changer mode) → (TV mode) → AUX mode → Radio mode...**

- External equipment not connected with CeNET is not displayed.

### Adjusting the volume

1. Turn the [ROTARY] knob to adjust the volume.
- The volume level is from 0 (minimum) to 33 (maximum).

### Switching the display

1. Each time you press the [DISP] button, the display switches in the following order:

**Main display → Clock display → Main display...**

- Once selected, the preferred display becomes the display default. When a function adjustment such as volume is made, the screen will momentarily switch to that function’s display, then revert back to the preferred display several seconds after the adjustment.

1. Press and hold the [DISP] button for 4 seconds or longer to turn off the display.
2. To turn on the display, press the [DISP] button again.



### ● When the power is turned off

1. Each time you press the [DISP] button, the display switches in the following order:  
**Clock display → Display off → Clock display...**

### Setting MAGNA BASS EXTEND

The MAGNA BASS EXTEND does not adjust the low sound area like the normal sound adjustment function, but emphasizes the deep bass sound area to provide you with a dynamic sound.

- This function cannot be adjusted when as follows: “Pro Logic” is set to “ON”, the speaker system is set to “5.1ch”, DVD/DTS-CD is being played.
  - The factory default setting is “OFF”.
1. Press and hold the [A-M] button for 1 second or longer to turn on.
  2. Press and hold the [A-M] button for 1 second or longer to turn off.

### Setting the Z-Enhancer Plus

This unit is provided with 4 types of sound tone effects stored in memory. Select the one you prefer.

- This function cannot be adjusted when as follows: “Pro Logic” is set to “ON”, the speaker system is set to “5.1ch”, DVD/DTS-CD is being played.
- The factory default setting is “Z+ OFF”.

1. Each time you press the [Z+] button, the tone effect changes in the following order:

“Z+ OFF” → “B-BOOST” → “IMPACT” → “EXCITE” → “CUSTOM” → “Z+ OFF”...

- **B-BOOST** : bass emphasized
- **IMPACT** : bass and treble emphasized
- **EXCITE** : bass and treble emphasized, mid de-emphasized
- **CUSTOM** : user custom
- **Z+ OFF** : no sound effect

### Adjusting the center speaker

- This function cannot be adjusted when as follows: “Pro Logic” is set to “ON”, the speaker system is set to “5.1ch”, DVD/DTS-CD is being played.
  - This function cannot be adjusted when the center speaker output is set to “OFF” or the speaker system is set to “2ch”. For details on how to set the center speaker, refer to the subsection “Turning on/off speakers” (P. 36) in the section “Changing Initial Settings such as Menu Language, etc.”.
  - The factory default setting is “C-VOL 0”.
1. Press the [A-M] button and select “C-VOL 0”.

2. Turn the [ROTARY] knob to select from -4 to +8 or OFF.
3. When the adjustment is complete, press the [A-M] button several times until the function mode is reached.

### Adjusting the subwoofer

- This function cannot be adjusted when as follows: “Pro Logic” is set to “ON”, the speaker system is set to “5.1ch”, DVD/DTS-CD is being played.
  - This function cannot be adjusted when the subwoofer output is set to “OFF”. For details on how to set the subwoofer, refer to the subsection “Turning on/off speakers” (P. 36) in the section “Changing Initial Settings such as Menu Language, etc.”.
  - The factory default setting is “SW-VOL 0”.
1. Press the [A-M] button and select “SW-VOL 0”.
  2. Turn the [ROTARY] knob to select from -6 to +6 or OFF.
  3. When the adjustment is complete, press the [A-M] button several times until the function mode is reached.

### Adjusting the Z-Enhancer Plus

- This function cannot be adjusted when as follows: “Pro Logic” is set to “ON”, the speaker system is set to “5.1ch”, DVD/DTS-CD is being played.
  - Press and hold the [Z+] button for 1 second or longer, then the setting parameter of bass/treble will be initialized with a display “Z+FLAT”.
1. Press the [Z+] button and select the Z-Enhancer Plus mode to adjust.
  2. Press the [A-M] button and select “B-BST 0” or “IMPACT 0” or “EXCITE 0”.
  3. Turn the [ROTARY] knob to select from -3 to +3.
  4. When the adjustment is complete, press the [A-M] button several times until the function mode is reached.

## Adjusting the bass

### (Gain, Frequency, Q-curve)

- This function cannot be adjusted when as follows:
    - “**Pro Logic**” is set to “**ON**”, the speaker system is set to “**5.1ch**”, DVD/DTS-CD is being played.
    - This adjustment can only be performed when the Z-Enhancer Plus is set to “**CUSTOM**”.
1. Press the [**A-M**] button and select “**BASS**”.
  2. Turn the [**ROTARY**] knob to adjust the bass.
    - The factory default setting is “**B<G 0>**”. (Adjustment range: -6 to +8)
  3. Move the [◀] / [▶] lever to select “**B<F 50>**”.
  4. Turn the [**ROTARY**] knob to select the frequency.
    - The factory default setting is “**B<F 50>**”. (Adjustment 50/80/120 Hz)
  5. Move the [◀] / [▶] lever to select “**B<Q 1>**”.
  6. Turn the [**ROTARY**] knob to select the Q-curve.
    - The factory default setting is “**B<Q 1>**”. (Adjustment 1/1.25/1.5/2)
  7. When the adjustment is complete, press the [**A-M**] button several times until the function mode is reached.

## Adjusting the treble

### (Gain, Frequency)

- This function cannot be adjusted when as follows:
    - “**Pro Logic**” is set to “**ON**”, the speaker system is set to “**5.1ch**”, DVD/DTS-CD is being played.
    - This adjustment can only be performed when the Z-Enhancer Plus is set to “**CUSTOM**”.
1. Press the [**A-M**] button and select “**TREBLE**”.
  2. Turn the [**ROTARY**] knob to adjust the treble.
    - The factory default setting is “**T<G 0>**”. (Adjustment range: -6 to +6)
  3. Move the [◀] / [▶] lever to select “**T<F 12K>**”.
  4. Turn the [**ROTARY**] knob to select the frequency.
    - The factory default setting is “**T<F 12K>**”. (Adjustment 8 kHz/12 kHz)
  5. When the adjustment is complete, press the [**A-M**] button several times until the function mode is reached.

## Adjusting the balance

- This function cannot be adjusted when as follows:
    - “**Pro Logic**” is set to “**ON**”, the speaker system is set to “**5.1ch**”, DVD/DTS-CD is being played.
1. Press the [**A-M**] button and select “**BAL 0**”.
  2. Turn the [**ROTARY**] knob to adjust the balance of the left and right speakers.
    - The factory default setting is “**BAL 0**”. (Adjustment range: L13 to R13)
  3. When the adjustment is complete, press the [**A-M**] button several times until the function mode is reached.

## Adjusting the fader

- This function cannot be adjusted when as follows:
    - “**Pro Logic**” is set to “**ON**”, the speaker system is set to “**5.1ch**”, DVD/DTS-CD is being played.
1. Press the [**A-M**] button and select “**FAD 0**”.
  2. Turn the [**ROTARY**] knob to adjust the balance of the front and rear speakers.
    - The factory default setting is “**FAD 0**”. (Adjustment range: F12 to R12)
  3. When the adjustment is complete, press the [**A-M**] button several times until the function mode is reached.

# Radio Operations

## Listening to the radio

1. Press the [SRC] button and select the radio mode. The frequency appears in the display.
2. Press the [BND] button and select the radio band. Each time the button is pressed, the radio reception band changes in the following order:  
**FM1 → FM2 → FM3 → AM → FM1...**
3. Move the [◀] / [▶] lever to tune in the desired station.

## Tuning

There are 3 types of tuning modes available, seek, manual and preset tuning.

### Seek tuning

1. Press the [BND] button and select the desired band (FM or AM).
- If "MANU" is lit in the display, press and hold the [BND] button for 1 second or longer. "MANU" in the display goes off and seek tuning is now available.
2. Move the [◀] / [▶] lever to automatically seek a station.

When the lever is moved up, the station is sought in the direction of higher frequencies; if the lever is moved down, the station is sought in the direction of lower frequencies.

## Manual tuning

There are 2 ways available: Quick tuning and step tuning.

When you are in the step tuning mode, the frequency changes one step at a time. In the quick tuning mode, you can quickly tune the desired frequency.

1. Press the [BND] button and select the desired band (FM or AM).
- If "MANU" is not lit in the display, press and hold the [BND] button for 1 second or longer. "MANU" is lit in the display and manual tuning is now available.
2. Tune into a station.

### ● Quick tuning:

1. Move the [◀] / [▶] lever for 1 second or longer to tune in a station.

### ● Step tuning:

1. Move the [◀] / [▶] lever to manually tune in a station.

## Recalling a preset station

A total of 24 preset positions (6-FM1, 6-FM2, 6-FM3, 6-AM) exists to store individual radio stations in memory. Pressing the corresponding [DIRECT] button recalls the stored radio frequency automatically.

1. Press the [BND] button and select the desired band (FM or AM).
2. Press the corresponding [DIRECT] button to recall the stored station.
- Press and hold one of the [DIRECT] buttons for 2 seconds or longer to store that station into preset memory.

## Manual memory

1. Select the desired station with seek tuning, manual tuning or preset tuning.
2. Press and hold one of the [DIRECT] buttons for 2 seconds or longer to store the current station into preset memory.

### **Auto store**

Auto store is a function for storing up to 6 stations that are automatically tuned in sequentially. If 6 receivable stations cannot be received, a previously stored station remains unoverwritten at the memory position.

1. Press the **[BND]** button and select the desired band (FM or AM).
2. Press and hold the **[PS/AS]** button for 2 seconds or longer. The stations with good reception are stored automatically to the preset channels.

### **Preset scan**

Preset scan receives the stations stored in preset memory in order. This function is useful when searching for a desired station in memory.

1. Press the **[PS/AS]** button.
2. When a desired station is tuned in, press the **[PS/AS]** button again to continue receiving that station.

#### **Note:**

- *Be careful not to press and hold the **[PS/AS]** button for 2 seconds or longer, otherwise the auto store function is engaged and the unit starts storing stations.*

### **Instant station recall (ISR)**

Instant station recall is a special radio preset that instantly accesses a favorite radio station at a touch of a button. The ISR function even operates with the unit in other modes.

#### ● **ISR memory**

1. Select the station that you wish to store in ISR memory.
2. Press and hold the **[ISR]** button for 2 seconds or longer.

#### ● **Recalling a station with ISR**

In any mode, press the **[ISR]** button to turn on the radio function and tune the selected radio station. "ISR" appears in the display. Press the **[ISR]** button again to return to the previous mode.

## DVD Operations

### ⚠ WARNING

#### About a Single CD/DVD (8cm DISC)

- Since the unit is not compatible with a single CD/DVD, do not load it into the unit.
- Keep in mind the fact that a single CD/DVD cannot be played even using a single CD/DVD adaptor for the unit.
- If you try to push it into the unit forcibly without removing it, the CD/DVD cannot be ejected. This will result in damage to the mechanism. Please never do this.

#### Loading a disc

1. Press the [OPEN] button to access the DVD/CD SLOT behind the FLIP DOWN PANEL.
2. Insert a DVD/CD into the center of the DVD/CD SLOT with the label side facing up. The DVD/CD plays automatically after loading.

#### Notes:

- Never insert foreign objects into the DVD/CD SLOT.
  - If the disc is not inserted easily, there may be another disc in the mechanism or the unit may require service.
3. Close the FLIP DOWN PANEL.

### ⚠ CAUTION

Be careful not to catch your hand or fingers while closing the FLIP DOWN PANEL.

#### Notes:

- If the FLIP DOWN PANEL does not open fully, gently open with your hand.
- After loading a CD, always close the FLIP DOWN PANEL.

#### Eject function

Just pressing the [▲] button ejects the disc even if the power to the unit was not turned on.

1. Press the [OPEN] button to open the FLIP DOWN PANEL.

#### Note:

- If the FLIP DOWN PANEL will not open far enough, open it gently with your hand.
2. Press the [▲] button. Remove the disc after it is ejected.

3. Close the FLIP DOWN PANEL.

#### Note:

- Always close the FLIP DOWN PANEL once you take out the disc.

### ⚠ CAUTION

- Do not try to put your hand or fingers in the disc insertion slot. Also never insert foreign objects into the slot.
- Do not insert discs where adhesive comes out from cellophane tape or a rental CD label, or discs with marks where cellophane tape or rental CD labels were removed. It may be impossible to extract these discs from the unit and they may cause the unit to break down.

#### Listening to a disc already loaded in the unit

1. Press the [SRC] button to select the DVD mode.

When the unit enters the DVD mode, play starts automatically.

If there is no disc loaded, the indication "NO DISC" appears in the display.

#### Note:

- The message "INVALID" will appear in the monitor when button operation is invalid.

## Watching a DVD-Video

For normal DVD-Video discs, the menu screen appears. The displayed contents may differ, depending on the DVD software.

### Selecting the DVD menu

1. Press the [MENU] button during playback.
  2. Select an item by pressing the [▲], [▼], [◀], [▶] buttons and press the [ENT] button to enter. Otherwise, select an item with the ten-key buttons on the remote control unit and press the [ENT] button to enter.
- Depending on the disc, items cannot be selected with the ten-key buttons.

### Stopping play

1. Press and hold the [▶||] button for 1 second or longer during playback.
2. Press the [▶||] button, and playback starts from the beginning of the disc.

### Pausing play

1. Press the [▶||] button during playback.
2. Press the [▶||] button, and playback resumes.

### Slow play

1. Press and hold the [SLOW] button on the remote control unit during playback, or move and hold the [◀] / [▶] lever up during pause.
- While the lever is being moved, slow playback continues at the speed 1/3 times the normal playback.
  - Slow playback cannot be performed in the backward direction. In addition, audio cannot be reproduced during slow playback.

### Skipping a chapter

Chapter means a small segment to divide the data area of the disc.

#### ● Chapter-up

1. Move the [◀] / [▶] lever up to move ahead to the beginning of the next chapter.

#### ● Chapter-down

1. Move the [◀] / [▶] lever down to move back to the beginning of the current chapter.

2. Move the lever down again within about 3 seconds to move to the beginning of the previous chapter.

### Fast-forward/fast-rewind

#### ● Fast-forward

1. Move the [◀◀] / [▶▶] lever up for 1 second or longer.

#### ● Fast-rewind

1. Move the [◀◀] / [▶▶] lever down for 1 second or longer.
- Move the lever, and the playback speed becomes 5-time faster first and then 20-time faster 3 seconds later. Release the lever, and the normal speed is restored.

### Repeat play

#### ● Chapter repeat

Plays back one chapter repeatedly.

1. Press the [RPT] button.

### Using the title menu

On DVD discs containing two or more titles, you can select from the title menu for playback.

1. Press the [DVD TITLE] button on the remote control unit or press and hold the [MENU] button for 1 second or longer on this unit during playback.
- Depending on the disc, the title menu cannot be called with [DVD TITLE] button.
2. Press the [▲], [▼], [◀], [▶] buttons or use the ten-key buttons to select an item.
- Depending on the disc, items cannot be selected with the ten-key buttons.
3. Press the [ENT] button.

## Searching with a chapter/title number

You can locate the beginning of the scene using the chapter numbers or title numbers recorded on the DVD-Video disc.

- This function can only be used from the remote control unit.
1. Press the **[SEARCH MODE]** button during playback.
  2. Each time you press the button, you can switch between title number input and chapter number input.

### ● Chapter

A small segment to divide the data area of the disc.

### ● Title

A large segment to divide the data area of the disc.

3. Input the number of the chapter or title that you want to play back with the ten-key buttons (0 to 9).
4. Press the **[ENT]** button on the remote control unit.

## Switching among languages

On discs in which two or more audios or audio languages have been recorded, you can switch among the audio languages during playback.

- This function can only be used from the remote control unit.
1. Press the **[AUDIO]** button during playback.
- Depending on the disc, up to 8 audios may be recorded. For details, see the mark of the disc (ⓐ): Indicates that 8 audios have been recorded).
  - When the power is turned on or when the disc is changed with a new one, the language set at the time of factory shipment is selected. If that language has not been recorded, the language specified on the disc is selected.
  - Depending on the disc, switching may be completely impossible or impossible on some scenes.
  - It may take time to switch among audios.

## Switching subtitles

On DVD discs in which two or more subtitle languages have been recorded, you can switch among the subtitle languages during playback.

- This function can only be used from the remote control unit.
1. Press the **[SUB TITLE]** button during playback.

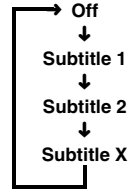

- Depending on the disc, up to 32 kinds of subtitles may be recorded. For details, see the mark of the disc (Ⓢ): Indicates that 8 kinds of subtitles have been recorded).
- Depending on the disc, switching may be completely impossible or impossible on some scenes.
- It may take time to switch among subtitles.

## Switching angles

On DVD discs in which video images have been recorded in two or more angles, you can switch among the angles during playback.

- This function can only be used from the remote control unit.
1. Press the **[ANGLE]** button during playback.
- Depending on the disc, up to 9 angles may be recorded. For details, see the mark of the disc (ⓐ): Indicates multi-angle).
  - Depending on the disc, angles may switch smoothly or switch with a momentary still image.
  - Depending on the disc, switching may be completely impossible or impossible on some scenes.
  - It may take time to switch among angles.
  - Depending on the disc, scenes recorded in two or more angles may be played back.

### Displaying the playback status

- This function can only be used from the remote control unit.
- Press the [P.TIME] button during playback.
  - Each time you press the button, you can switch between display (ON) and non-display (OFF) of the playback status.

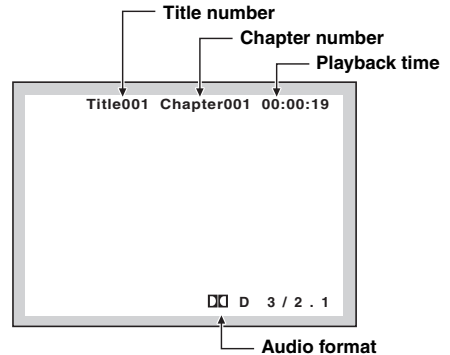

## Watching a video CD (V-CD)

For V-CD discs equipped with the PBC (Play Back Control) function, the menu screen appears. The displayed contents may differ, depending on the V-CD software.

### Playback control (PBC)

This control signal is recorded on a Video CD for version 2.0 and used to control playback. Using pre-recorded menu screens in the Video CD with PBC, you can enjoy playback of software with a simplified dialog function or software with search function. You can also enjoy a still picture at high or standard resolution.

### Turning on/off PBC

On video CDs equipped with Play Back Control function, you can turn it on/off.

- This function can only be used from the remote control unit.
  - The factory default setting of PBC is "ON".
- Press the [PBC] button.
  - Each time you press the button, you can switch between on and off.
- When the PBC is turned on or off, the disc plays from the beginning.

### Selecting the V-CD menu

- You can do this operation when PBC is ON for a disc with PBC functions.
- Press the [MENU] button during playback.
  - Select an item by pressing the [▲], [▼], [◀], [▶] buttons and press the [ENT] button to enter. Otherwise, select an item with the ten-key buttons on the remote control unit and press the [ENT] button to enter.
- Depending on the disc, items cannot be selected with the ten-key buttons.

### Pausing play

- Press the [▶||] button during playback.
- Press the [▶||] button, and playback resumes.

### Slow play

- Press and hold the [SLOW] button on the remote control unit during playback, or move and hold the [◀◀] / [▶▶] lever up during pause.
- While the lever is being moved, slow playback continues at the speed 1/3 times the normal playback.
  - Slow playback cannot be performed in the backward direction. In addition, audio cannot be reproduced during slow playback.



## Skipping a track

### ● Track-up

1. Move the [◀◀] / [▶▶] lever up to move ahead to the beginning of the next track.

### ● Track-down

1. Move the [◀◀] / [▶▶] lever down to move back to the beginning of the current track.
2. Move the lever down again within about 2 seconds to move to the beginning of the previous track.

#### Note:

- This operation cannot be performed on some discs with PBC.

## Fast-forward/fast-rewind

### ● Fast-forward

1. Move the [◀◀] / [▶▶] lever up for 1 second or longer.

### ● Fast-rewind

1. Move the [◀◀] / [▶▶] lever down for 1 second or longer.
- Move the lever, and the playback speed becomes 5-time faster first and then 20-time faster 3 seconds later. Release the lever, and the normal speed is restored.

## Searching with a track number

This operation allows searching with the track numbers recorded on the video CDs.

- This function can only be used from the remote control unit.
  - You cannot do this operation when PBC is ON for a disc with PBC functions.
1. Press the [SEARCH MODE] button during playback.
  2. Input the number of the track that you want to play back with the ten-key buttons (0 to 9).
  3. Press the [ENT] button on the remote control unit.

## Changing audio output

You can change the audio output method.

- This function can only be used from the remote control unit.
1. Press the [AUDIO] button during playback.
  2. Each time you press the button, you can switch among audio output methods.

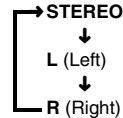

## Displaying the playback status

- This function can only be used from the remote control unit.
1. Press the [P.TIME] button during playback.
  2. Each time you press the button, you can switch between display (ON) and non-display (OFF) of the playback status.

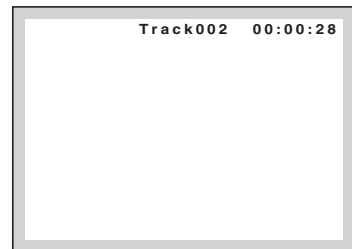

## Listening to a CD

This unit supports the display of the DISC TITLE, TRACK TITLE and ARTIST of the CD TEXT.

- Example showing CD TEXT display.

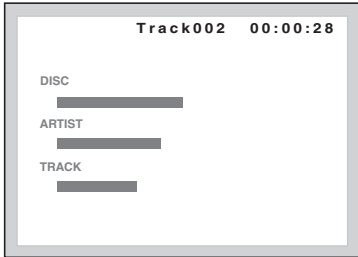

### Note:

- This unit supports only CD TEXT in alphanumeric. Also, some character data may not be reproduced properly on the monitor.

### Top function

The top function resets the CD player to the first track of the disc.

1. Press the [BND] button to play the first track (track No. 1) on the disc.

### Pausing play

1. Press the [▶|||] button during playback.
2. Press the [▶|||] button again, and playback resumes.

### Displaying CD titles

This unit can display title data for CD-text disc and user titles input with this unit.

1. Each time you press the [TITLE] button, the title changes in the following order:

**User title (disc) → CD-text title (disc) → Artist name → CD-text title (track) → User title (disc)...**

### Note:

- If the CD playing is not a CD-text CD or no user title has been input, "NOTITL" appears in the display.

### Skipping a track

#### ●Track-up

1. Move the [◀◀] / [▶▶] lever up to move ahead to the beginning of the next track.

#### ●Track-down

1. Move the [◀◀] / [▶▶] lever down to move back to the beginning of the current track.
2. Move the lever down again within about 2 seconds to move to the beginning of the previous track.

### Fast-forward/fast-rewind

#### ●Fast-forward

1. Move the [◀◀] / [▶▶] lever up for 1 second or longer.

#### ●Fast-rewind

1. Move the [◀◀] / [▶▶] lever down for 1 second or longer.
- Move the lever, and the playback speed becomes 5-time faster first and then 20-time faster 3 seconds later. Release the lever, and the normal speed is restored.

### Searching with a track number

This operation allows searching using the track numbers recorded on the CDs.

- This function can only be used from the remote control unit.
1. Press the [SEARCH MODE] button during playback.
  2. Input the number of the track that you want to play back with the ten-key buttons (0 to 9).
  3. Press the [ENT] button on the remote control unit.

### Scan play

This operation scans and plays back all tracks recorded on the disc, the first 10 seconds for each.

1. Press the [SCN] button.

### Repeat play

This operation plays back tracks recorded on the CD repeatedly.

1. Press the [RPT] button.

### Random play

This operation plays back all tracks on the disc in no particular order.

1. Press the [RDM] button.

## Listening to an MP3/WMA

- Example showing WMA/ID3 Tag display.

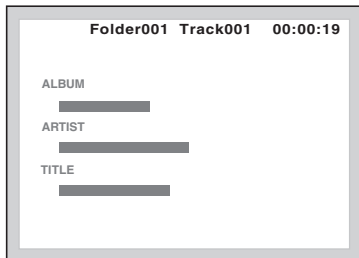

#### Note:

- This unit supports only WMA/ID3 Tag information in ASCII characters. Also, some character data may not be reproduced properly on the monitor.

### What is MP3?

MP3 is an audio compression method and classified into audio layer 3 of MPEG standards. This audio compression method has penetrated into PC users and become a standard format.

This MP3 features the original audio data compression to about 10 percent of its initial size with a high sound quality. This means about 10 music CDs can be recorded on a CD-R disc or CD-RW disc to allow a long listening time without having to change CDs.

### What is WMA?

WMA is the abbreviation of Windows Media Audio, an audio file format developed by Microsoft Corporation.

#### Note:

- If you play a file with DRM (Digital Rights Management) for WMA remaining ON, playback stops and the message "DRM" appears in the display. (The WMA indicator blinks.)

#### ● To disable DRM (Digital Rights Management):

1. When using Windows Media Player 9, click on TOOLS → OPTIONS → MUSIC RECORD tab, then under Recording settings, unclick the Check box for RECORD PROTECTED MUSIC. Then, reconstruct files.
  2. When using Windows Media Player 10, click on TOOLS → OPTIONS → RIP MUSIC tab, then under RIP SETTINGS, unclick the Check box for COPY PROTECT MUSIC. Then, reconstruct files.
- Personally constructed WMA files are used at your own responsibility.

## Precautions when creating MP3/WMA disc

### ● Usable sampling rates and bit rates:

1. MP3: Sampling rate 32 kHz-48 kHz, Bit rate: 8 kbps-320 kbps / VBR
2. WMA: Bit rate 32 kbps-192 kbps

### ● File extensions

1. Always add a file extension “.MP3” or “.WMA” to MP3 or WMA file by using single byte letters. If you add a file extension other than specified or forget to add the file extension, the file cannot be played.
2. If files other than MP3/WMA are played, playback stops and the message “NOT SPRT” appears in the display.

### ● Logical format (File system)

1. When writing MP3/WMA file on a CD-R disc or CD-RW disc, please select “ISO9660 level 1, 2 or JOLIET or Romeo” as the writing software format. Normal play may not be possible if the disc is recorded on another format.
2. The folder name and file name can be displayed as the title during MP3/WMA play but the title must be within 62 single byte ASCII characters (including an extension).
3. Do not affix a name to a file inside a folder having the same name.

### ● Folder structure

1. A disc with a folder having more than 8 hierarchical levels will be impossible.

### ● Number of files or folders

1. Up to 512 files/512 folders can be played. But if there are 999 files in one folder, other folders cannot be played.
2. Tracks are played in the order that they were recorded onto a disc. (Tracks might not always be played in the order displayed on the PC.)
3. Some noise may occur depending on the type of encoder software used while recording.
4. In case of a track recorded at VBR (variable bit rate), the display for the play time of the track may be slightly different from the actual play time.

Also, the recommended value of VBR ranges from 64 kbps to 320 kbps.

5. Depending on the damage conditions of a file, it may occur that the file is not played and the next file is played instead.

Also, if the damage is in a severe condition, playback stops and the error message appears in the display. For details on error messages, refer to the section “11. ERROR DISPLAYS” (P. 49).

## Top function

The top function resets the MP3/WMA player to the first track of a folder being played.

1. Press the [BND] button to play the first track (track No. 1) of a folder.

## Pausing play

1. Press the [▶||] button during playback.
2. Press the [▶||] button again, and playback resumes.

## Displaying MP3/WMA titles

This unit can display title data for MP3/WMA disc.

1. Each time you press the [TITLE] button, the title changes in the following order:

**Folder → TRACK → Album TAG → Artist TAG → Title TAG → Folder...**

### Notes:

- If MP3/WMA disc is not input TAG, “NO TAG” appears in the display.
- For MP3, supports ID3 Tags V2.4 / 2.3 / 1.1 / 1.0.
- Tag displays give priority to V2.4 / 2.3.
- In the case of album Tags for WMA, the information written into the extension header is displayed.
- Only ASCII characters can be displayed in Tags.

## ***Skipping a track***

### ● **Track-up**

1. Move the [◀◀] / [▶▶] lever up to move ahead to the beginning of the next track.

### ● **Track-down**

1. Move the [◀◀] / [▶▶] lever down to move back to the beginning of the current track.
2. Move the lever down again within about 2 seconds to move to the beginning of the previous track.

## ***Folder select***

This function allows you to select a folder containing MP3/WMA files and start playing from the first track in the folder.

- This function can only be used from the main unit.

1. Press the [DN] button to move to the previous folder.
2. Press the [UP] button to move to the next folder.

## ***Fast-forward/fast-rewind***

### ● **Fast-forward**

1. Move the [◀◀] / [▶▶] lever up for 1 second or longer.

### ● **Fast-rewind**

1. Move the [◀◀] / [▶▶] lever down for 1 second or longer.
- Move the lever, and the playback speed becomes 5-time faster first and then 20-time faster 3 seconds later. Release the lever, and the normal speed is restored.

## ***Searching with a folder/track number***

This operation allows searching using the folder and track numbers recorded on the MP3/WMA disc.

- This function can only be used from the remote control unit.

1. Press the [SEARCH MODE] button during playback.
2. Each time you press the button, you can switch between folder number input and track number input.
3. Input the number of the track or folder that you want to play back with the ten-key buttons (0 to 9).

4. Press the [ENT] button on the remote control unit.

## ***Track scan play***

This operation plays back all tracks recorded on the disc, about 10 seconds for each.

1. Press the [SCN] button.

## ***Folder scan play***

This operation plays back the first tracks of all folders on the MP3/WMA disc, about 10 seconds for each.

1. Press and hold the [SCN] button for 1 second or longer.
- Scan playback starts from the first track of the next folder to the one currently being played back.

## ***Track repeat play***

This operation plays back the track currently being played back repeatedly.

1. Press the [RPT] button.

## ***Folder repeat play***

This operation plays back tracks in an MP3/WMA folder repeatedly.

1. Press and hold the [RPT] button for 1 second or longer.

## ***Track random play***

This operation plays the tracks in the folder in a random order.

1. Press the [RDM] button.

## ***Folder random play***

This operation plays back tracks recorded on the disc in no particular order.

1. Press and hold the [RDM] button for 1 second or longer.

# Changing Initial Settings such as Menu Language, etc.

## Selecting the monitor menu

### Notes:

- The setup main menu appears only while in the DVD mode.
- “**PREFERENCES**” appears only when there is no disc loaded and playback stops.
- Menu settings described in this section are displayed on the monitor.

If the set language has not been recorded on the disc, the language specified on the disc is used for display.

1. Press the [SET UP] button on the remote control unit or press and hold the [ADJ] button on the unit for 1 second or longer in the DVD mode to display the main menu.
2. Select “GENERAL SETUP”, “PREFERENCES”, or “AUDIO SETUP” with the “▲” or “▼” button and press the [ENT] to enter.
3. Press the “▲” or “▼” button to select the left menu item.
4. Press the “▶” button to go to the option list.
5. Press the “◀” button to go to back to the left menu item.
6. Press the [RTN] button to display the main menu.
7. Press the [SET UP] button on the remote control unit or press the [ADJ] button on the unit to return to the original mode from the setup mode engaged.

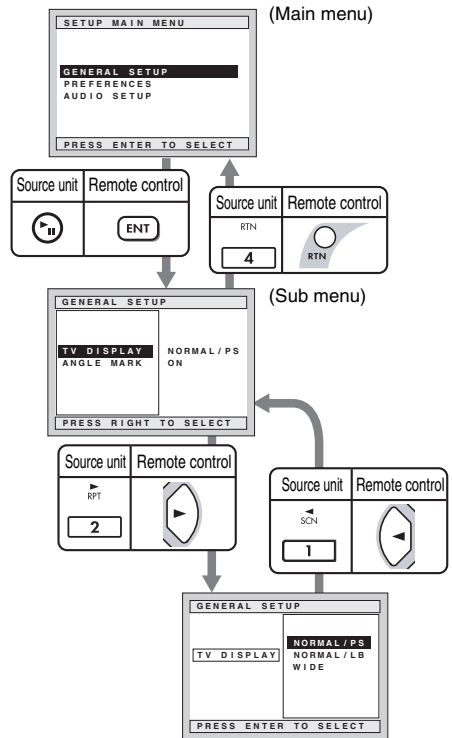

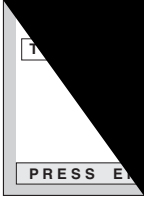

2. Press the “▲” or “▼” key to change the screen size.

- The color of the selected item is highlighted.

● **When watching TV**

**TV monitor (4:3)**

- **NORMAL/PS** : The top and bottom of the screen are cut off.

This function is used to adjust the aspect ratio of the screen. In some cases, the screen may be distorted. To prevent this, the screen is distorted (screen aspect ratio).

- **NORMAL/PS** : The top and bottom of the screen are cut off.



When watching Cinema Scope and Vista movies, the top and bottom of the screen are cut off by the screen aspect ratio. To prevent this, the screen is distorted on the top and bottom.

### Setting up the audio language

- The factory default setting is "ENGLISH".

- Following the steps 1 to 3 in "Selecting the monitor menu", select "AUDIO" from "PREFERENCES", and press the "▶" button to go to the option list.

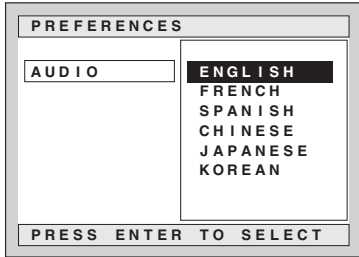

- Press the "▲" or "▼" button to select a language to be used.

Languages SELECT in the order:

ENGLISH  
 ↓  
 FRENCH  
 ↓  
 SPANISH  
 ↓  
 CHINESE  
 ↓  
 JAPANESE  
 ↓  
 KOREAN

- Press the [ENT] button.

### Setting up the subtitle language

- The factory default setting is "OFF".

- Following the steps 1 to 3 in "Selecting the monitor menu", select "SUBTITLE" from "PREFERENCES", and press the "▶" button to go to the option list.

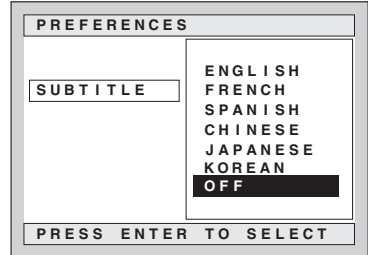

- Press the "▲" or "▼" button to select a language to be used.

Languages SELECT in the order:

ENGLISH  
 ↓  
 FRENCH  
 ↓  
 SPANISH  
 ↓  
 CHINESE  
 ↓  
 JAPANESE  
 ↓  
 KOREAN  
 ↓  
 OFF

- Press the [ENT] button.



### Setting up the disc menu language

- The factory default setting is "ENGLISH".
- Following the steps 1 to 3 in "Selecting the monitor menu", select "DISC MENU" from "PREFERENCES", and press the "▶" button to go to the option list.

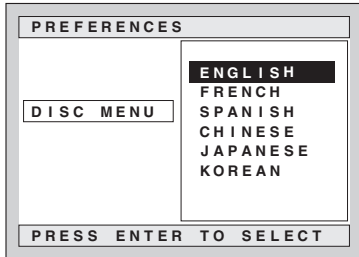

- Press the "▲" or "▼" button to select a language to be used.

Languages SELECT in the order:



- Press the [ENT] button.

### Setting up the country code

Set up the country number for setting up of the parental level.

- The default setting is "8583" (US).
- Following the steps 1 to 3 in "Selecting the monitor menu", select "LOCALE" from "PREFERENCES", and press the "▶" button to go to the option list.

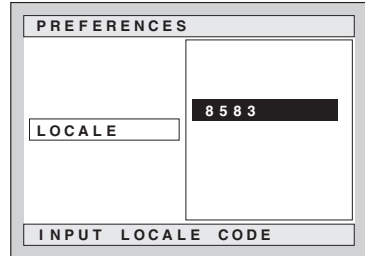

- Press the [ENT] button to display the input screen.
- Press the ten-key buttons to input a 4-digit country number.
- Press the [ENT] button.

#### ● Country code list

Country	Input code
<b>Region number 3</b>	
BRUNEI DARUSSALAM	6678
Kingdom of Cambodia	7572
INDONESIA	7368
KOREA, DEMOCRATIC PEOPLE'S REPUBLIC OF	7580
KOREA, REPUBLIC OF	7582
LAO PEOPLE'S DEMOCRATIC REPUBLIC	7665
MALAYSIA	7789
MYANMAR	7777
PHILIPPINES	8072
SINGAPORE	8371
THAILAND	8472
VIET NAM	8678
EAST TIMOR	8480
HONG KONG	7275
MACAU	7779
TAIWAN, PROVINCE OF CHINA	8487
<b>Region number 4</b>	
ANTIGUA AND BARBUDA	6571
ARGENTINA	6582
AUSTRALIA	6585
BAHAMAS	6683
BARBADOS	6666

Country	Input code
BELIZE	6690
BOLIVIA	6679
BRAZIL	6682
CHILE	6776
COLOMBIA	6779
COSTA RICA	6782
CUBA	6785
DOMINICA	6877
DOMINICAN REPUBLIC	6879
ECUADOR	6967
EL SALVADOR	8386
FIJI	7074
GRENADA	7168
GUATEMALA	7184
GUYANA	7189
HAITI	7284
HONDURAS	7278
JAMAICA	7477
KIRIBATI	7573
MARSHALL ISLANDS	7772
MEXICO	7788
MICRONESIA, FEDERATED STATES OF	7077
NAURU	7882
NEW ZEALAND	7890
NICARAGUA	7873
PALAU	8087
PANAMA	8065
PAPUA NEW GUINEA	8071
PARAGUAY	8089
PERU	8069
SAINT KITTS AND NEVIS	7578
SAINT LUCIA	7667
SAINT VINCENT AND THE GRENADINES	8667
SAMOA	8783
SOLOMON ISLANDS	8366
SURINAME	8382
TONGA	8479
TRINIDAD AND TOBAGO	8484
TUVALU	8486
URUGUAY	8589
VANUATU	8689
VENEZUELA	8669
ANGUILLA	6573
ARUBA	6587
VIRGIN ISLANDS (BRITISH)	8671
CAYMAN ISLAND	7589
CHRISTMAS ISLAND	6789

Country	Input code
COCOS (KEELING) ISLANDS	6767
COOK ISLANDS	6775
FALKLAND ISLANDS (MALVINAS)	7075
FRENCH GUIANA	7170
FRENCH POLYNESIA	8070
GADELOUPE	7180
GUAM	7185
MARTINIQUE	7781
MONTERRAT	7783
NETHERLANDS ANTILLES	6578
NEW CALEDONIA	7867
NIUE	7885
NORFOLK ISLAND	7870
NORTHERN MARIANA ISLANDS	7780
PITCAIRN	8078
TOKELAU	8475
TURKS AND CAICOS ISLANDS	8467
WALLIS AND FUTUNA ISLANDS	8770

## Setting up the parental level

You can change the level of parental lock (audiovisual restriction).

This function allows cutting scenes that are unfavorable for children or replacing them automatically with other scenes prepared in advance. For example, by replacing scenes of radical violence or portrayals of sex with safe scenes, you can make a trouble-free story as if it were so from the beginning.

- The factory default setting is level "8".
1. Following the steps 1 to 3 in "Selecting the monitor menu", select "PARENTAL" from "PREFERENCES", and press the "▶" button to go to the option list.

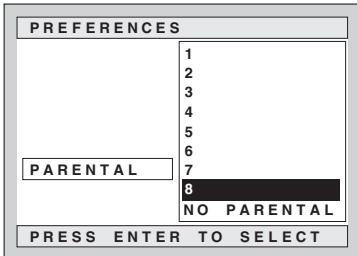

2. Press the "▲" or "▼" button to select a parental level.  
You can select from 1 to 8 or NO PARENTAL.
3. Press the [ENT] button.

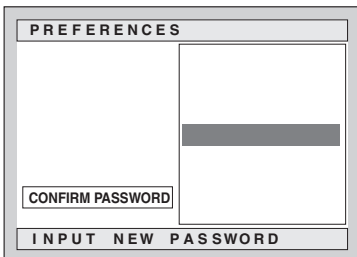

4. Press the ten-key buttons to input a 4-digit confirm password.
  - Factory default setting is "0000".
  - For details on how to set the password, refer to the subsection "Setting up the password for setting up of the parental level" (P. 35) in the section "Changing Initial Settings such as Menu Language, etc."

## Setting up the password for setting up of the parental level

1. Following the steps 1 to 3 in "Selecting the monitor menu", select "PASSWORD" from "PREFERENCES", and press the "▶" button to go to the option list.

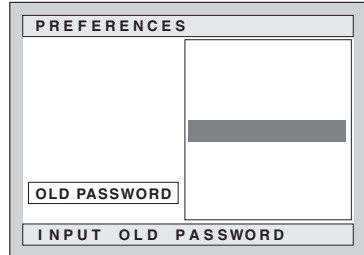

2. Press the ten-key buttons to input a 4-digit old password.
  - Factory default setting is "0000".
3. Input a new password.

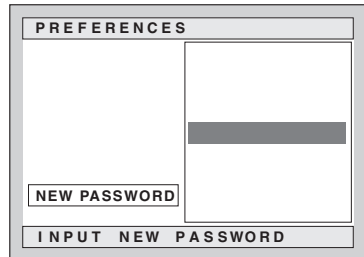

4. Input a confirm password.

**It is recommended that you take down a memo about the password and keep it safely to avoid forgetting it.**

**If you forget your password, you can set a new password by entering [4356] as the OLD PASSWORD. Entering [4356], the password will be back to "0000".**

### Note:

**When a disc with view limited is played**

- When a disc with view limited is played, the input screen requiring you to input the password may appear. When this happens, enter the correct password, otherwise play does not start.

### Turning on/off speakers

You can turn on/off or select the size of front speakers, a center speaker, surround speakers, and a subwoofer depending on your speaker system.

- Following the steps 1 to 3 in “**Selecting the monitor menu**”, select “**SPEAKER-SEL**” from “**AUDIO SETUP**”.

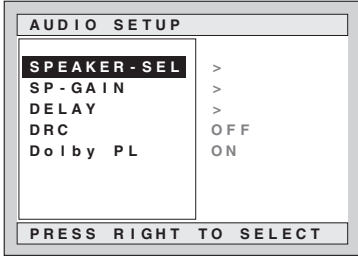

- Press the “▶” button to display the SPEAKER-SEL screen.

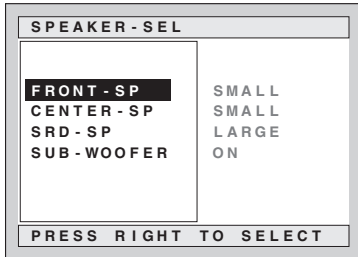

Each time you press “▲” or “▼” buttons, the setting item changes as following order:

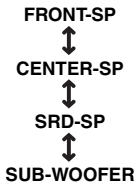

- Press the “▶” button to go to the option list and press “▲” or “▼” buttons to select the setting.

You can select the settings as shown in the following table.

FRONT-SP (Front speaker)	LARGE
	SMALL *
CENTER-SP (Center speaker)	SMALL *
	OFF
SRD-SP (Surround speaker)	LARGE *
	SMALL
	OFF
SUB-WOOFER (Subwoofer)	ON *
	OFF

Asterisk (\*) indicates the factory default setting.

- Press the [ENT] button.
- Repeat steps 2 to 4 to turn on/off each speaker.

### Adjusting the speaker gain

- The factory default setting is “0 dB”.

- Following the steps 1 to 3 in “**Selecting the monitor menu**”, select “**SP-GAIN**” from “**AUDIO SETUP**”.

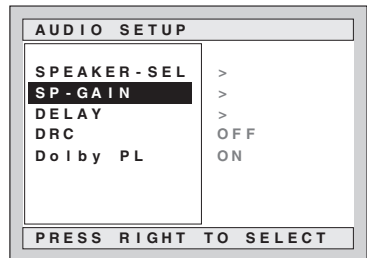

- Press the “▶” button to display the SP-GAIN screen.

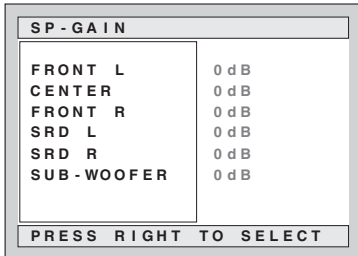

- Press “▲” or “▼” buttons to select the speaker.

Each time you press the buttons, you can switch among speakers.

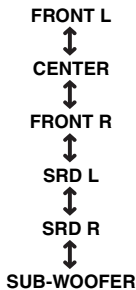

The test tone is output from the speaker you select.

- Press “▶” button to go to the right pane.
- Press “▲” or “▼” buttons to adjust the speaker gain. The gain level ranges from “-6dB” to “+6dB”.
- Press the “◀” button to go back to the left pane.
- Repeat steps 3 to 5 to adjust the each speaker gain.

**Note:**

- The test tone will not be output when DVD or CD is being played with mute ON. In that case, press the [MUTE] button on the remote control unit to cancel the mute, or adjust the volume.

## Adjusting the speaker delay time

The time necessary for sound to travel from speakers to a listener differs depending on the speaker location or the car size. By adjusting the delay time of each speaker, you can hear the sound from the front speakers and the other speakers simultaneously.

- The factory default setting is “0 ms”.

- Following the steps 1 to 3 in “Selecting the monitor menu”, select “DELAY” from “AUDIO SETUP”.

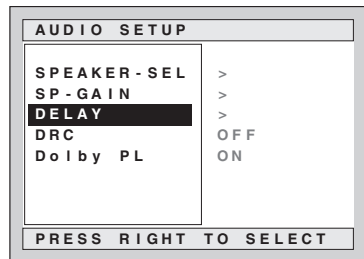

- Press the “▶” button to display the DELAY screen.

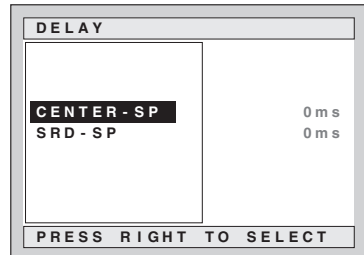

- Press “▲” or “▼” buttons to select the item. Each time you press the buttons, you can switch between center and surround speakers.

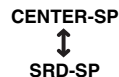

- Press “▶” button to go to the right pane.
- Press “▲” or “▼” buttons to adjust the delay time. The delay time ranges from “0 ms” to “15 ms” when you select “CENTER-SP” or “SRD-SP”.
- Press the [ENT] button.

### Adjusting the dynamic range

This function allows you to adjust the dynamic range, the ratio of the loudest sounds to the quietest sounds.

- The factory default setting is “OFF”.
1. Following the steps 1 to 3 in “**Selecting the monitor menu**”, select “DRC” from “**AUDIO SETUP**”.
  2. Press “▶” button to go to the right pane.

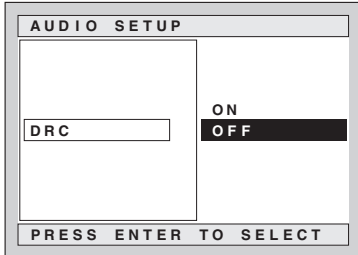

3. Press “▲” or “▼” buttons to select the setting. You can select the dynamic range from “ON” or “OFF”.
4. Press the [ENT] button.

### Setting the Dolby Pro Logic Decode processing

You can set whether or not 2-channel source is processed using Dolby Pro Logic Decode.

- The factory default setting is “ON”.
1. Following the steps 1 to 3 in “**Selecting the monitor menu**”, select “Dolby PL” from “**AUDIO SETUP**”.
  2. Press “▶” button to go to the right pane.

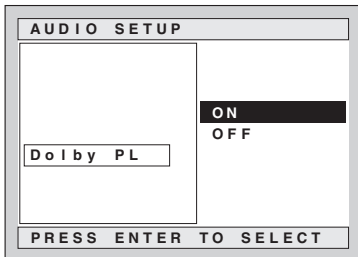

3. Press “▲” or “▼” buttons to select “ON” or “OFF”.
4. Press the [ENT] button.

### Setting the down mix

This function allows you to select the method of down-mixing when the channel format and the output channel configuration are not in agreement.

- This function can be operated only when the speakers other than “FRONT-SP” are set to “OFF” in “**SPEAKER-SEL**” (P. 36).
  - The factory default setting is “Lo/Ro”.
1. Following the steps 1 to 3 in “**Selecting the monitor menu**”, select “DOWN MIX” from “**AUDIO SETUP**”.
  2. Press “▶” button to go to the right pane.

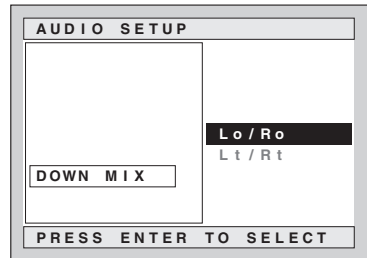

3. Press “▲” or “▼” buttons to select “Lo/Ro” or “Lt/Rt”.
  - “Lo/Ro”: Down-mixing the discrete 5-channel master etc. to 2-channel stereo track
  - “Lt/Rt”: Writing down matrix-encoded sounds to 2-channel stereo track
4. Press the [ENT] button.

## Different Pieces of Music Heard by Plural Listeners (2-ZONE function)

### About the 2-ZONE function

The 2-ZONE function is a function that outputs separate sounds from the MAIN zone and SUB zone by simultaneously operating two sources in the one center unit, thereby allowing plural listeners to enjoy separate music sources.

The sources of the MAIN zone are played back from the speakers of the vehicle side, and those of the SUB zone are from the headphone systems (WH104/WH204).

#### Notes:

- You can adjust the sound level only for the MAIN zone. To adjust the sound level for the SUB zone, adjust it in the headphone (WH104/WH204) side.
- The Audio mode and Z-enhancer function cannot be set for the sources of the SUB zone.
- You cannot select the radio mode while SUB zone is selected as control zone.
- If a cellular phone interrupt occurs when the external equipment is selected in the SUB zone, 2-ZONE function will be canceled.
- You cannot select different external equipments (TV tuner/CD changer) for MAIN and SUB zone.

### Setting the 2-ZONE function

- The initial setting is "OFF".

When you have set the 2-ZONE function to "ON" in the initial state, the MAIN zone services for sources inside this unit and the SUB zone, for DVD. Changing a source during later use causes the latest heard source to be invoked.

- Press and hold the [  ] button for 1 second or longer to turn on or off. When the 2-ZONE function is turned on, "2-ZONE" on the display lights.

### Switching sources

- Press the [  ] button to select the control zone ("MAIN" or "SUB").
- Every time the button is pressed, the "MAIN ZONE" changes to the "SUB ZONE" or vice versa. "MAIN" or "SUB" on the display lights at that time, thereby indicating that the relevant zone becomes ready to operate.
- Press the [SRC] button to select a source in the control zone.

### ● Example for source change

		MAIN (FRONT)					
		Internal			External		
		Radio	DVD	AUX	CD Changer	TV	
SUB (REAR)	Internal	DVD	○	○	○	○	○
		AUX	○	○	○	○	○
	External	CD Changer	○	○	○	○	×
		TV	○	○	○	×	○

## Common Operations

### Display Adjust Mode

#### Setting the clock

1. Press and hold the [DISP] button for 1 second or longer to switch to the display adjust mode.
2. Move the [◀] / [▶] lever to select "CLOCK".
3. Press the [▶||] button.
4. Move the [◀] / [▶] lever to select the hour or the minute.
5. Turn the [ROTARY] knob to set the correct time.
  - The clock is displayed in 12-hour format.
6. Press the [▶||] button to store the time into memory.
7. Press the [DISP] button to return to the previous mode.

#### Note:

- You cannot set the clock when it is displayed with only the ignition on. If you drain or remove the car's battery or take out this unit, the clock is reset. While setting the clock, if another button or operation is selected, the clock set mode is canceled.

### Turning the screen saver function on or off

This unit features various screen saver patterns that are exhibited across the display. If the screen savers are not desired, they can be turned off.

If the button operation is performed with the screen saver function on, the operation display corresponding to the button operation is shown for about 30 seconds and the display returns to the screen saver display.

- The factory default setting is "ON".
1. Press and hold the [DISP] button for 1 second or longer to switch to the display adjust mode.
  2. Move the [◀] / [▶] lever to select "SCRN SVR".
  3. Turn the [ROTARY] knob to select the setting. Each time you turn the [ROTARY] knob, the setting changes in the following order:

**OFF → ON → MESSAGE**

4. Press the [DISP] button to return to the previous mode.

### Entering MESSAGE INFORMATION

When "MESSAGE" is selected for the screen saver setting, you can change the contents of the message.

- Up to 30 characters can be entered.
  - The factory default setting is "WELCOME TO CLARION".
1. Press and hold the [DISP] button for 1 second or longer to switch to the display adjust mode.
  2. Move the [◀] / [▶] lever to select "INPUT".
  3. Press the [▶||] button.
  4. Move the [◀] / [▶] lever to move the cursor.
  5. Press the [BND] button to select a character. Each time you press the [BND] button, the character changes in the following orders:  
**Capital letters → Numbers → Symbols → Umlaut → Capital letters...**
  6. Turn the [ROTARY] knob to select the desired character.
  7. Repeat steps 4 to 6 to enter up to 30 characters for message.
  8. Press and hold the [▶||] button for 2 seconds or longer to store the message in memory and return to the display adjust mode.
    - Press and hold the [BND] button for 1 second or longer to delete the message. Then press and hold the [▶||] button for 2 seconds or longer to return the message to the default setting.
  9. Press the [DISP] button to return to the previous mode.



## Setting the method for title scroll

Set how to scroll in CD-TEXT, MP3/WMA TITLE.

- The factory default setting is “ON”.
1. Press and hold the [DISP] button for 1 second or longer to switch to the display adjust mode.
  2. Move the [◀] / [▶] lever to select “SCROLL”.
  3. Turn the [ROTARY] knob to select “ON” or “OFF”.

### ● ON:

Scrolls automatically.

### ● OFF:

Scrolls just 1 time when the title was changed or you press and hold the [TITLE] button for 1 second or longer.

4. Press the [DISP] button to return to the previous mode.

## Dimmer control

You can set the dimmer control.

- The factory default setting is “ON”.
1. Press and hold the [DISP] button for 1 second or longer to switch to the display adjust mode.
  2. Move the [◀] / [▶] lever to select “DIMMER”.
  3. Turn the [ROTARY] knob to select “ON” or “OFF”.
  4. Press the [DISP] button to return to the previous mode.

## Adjust Mode

### Anti-theft indicator

The red Anti-theft indicator is a function for deterring theft. When the DCP is removed from the unit, this indicator blinks.

- The factory default setting is “OFF”.
1. Press the [ADJ] button to switch to the adjust mode.
  2. Move the [◀] / [▶] lever to select “LED”.
  3. Turn the [ROTARY] knob to select “ON” or “OFF”.
  4. Press the [ADJ] button to return to the previous mode.

## Setting the low pass filter

- This function can only be adjusted when the subwoofer output is set to “ON” and the speaker system is set to “5.1ch”. For details on how to set the subwoofer, refer to the subsection “Turning on/off speakers” (P. 36) in the section “Changing Initial Settings such as Menu Language, etc.”.
- This function cannot be adjusted when as follows: “Pro Logic” is set to “ON”, the speaker system is set to “5.1ch”, DVD/DTS-CD is being played.
- The factory default setting is “THROUGH”. If the speaker system is set to “5.1ch”, the factory default setting is “50Hz”.

1. Press the [ADJ] button to switch to the adjust mode.
2. Move the [◀] / [▶] lever to select “SW LPF”.
3. Turn the [ROTARY] knob to select the setting. Each time you turn the [ROTARY] knob, the setting changes in the following order:  
**THROUGH → 50Hz → 80Hz → 120Hz**
4. Press the [ADJ] button to return to the previous mode.

## Setting the amplifier bypass circuit

- The factory default setting is “OFF”.
1. Press the [ADJ] button to switch to the adjust mode.
  2. Move the [◀] / [▶] lever to select “AMP CNCL”.
  3. Turn the [ROTARY] knob to select “ON” or “OFF”.
- ON:  
Uses with connected AMP.
- OFF:  
Uses with inside AMP.
4. Press the [ADJ] button to return to the previous mode.

## Adjusting the auxiliary input sensitivity

Adjust the auxiliary sensitivity when the audio from an external device is difficult to hear even after adjusting the volume.

- The factory default setting is “MID”.
1. Press the [ADJ] button to switch to the adjust mode.
  2. Move the [◀] / [▶] lever to select “AUX SENS”.
  3. Turn the [ROTARY] knob to select from “LOW”, “MID” or “HIGH”.
  4. Press the [ADJ] button to return to the previous mode.

## Performing a system check

This function verifies the devices hooked up through CeNET.

1. Press the [ADJ] button to switch to the adjust mode.
2. Move the [◀] / [▶] lever to select “SYSTEM”.
3. Press and hold the [▶|||] button for 1 second or longer to start the system check.

The digital connection configuration is automatically checked.

4. When the system check is complete, perform the speaker setting.

Turn the [ROTARY] knob to select the speaker system and press the [▶|||] button.

The display returns to the previous mode.

For details on the speaker setting, refer to the “System check and speaker setting” (P. 16).

### Note:

- When the speaker setting has been changed by a system check, the previously set “AUDIO SETUP” returns to its default setting.

## Other operations

### Entering titles

Titles up to 8 characters long can be stored in memory and displayed for CD, CD changer and Radio/TV stations. The number of titles that can be entered for each mode are as follows.

Mode	Number of titles
CD mode	50 titles
TV mode	20 titles
Radio mode	30 titles

CD changer mode	Number of titles
DCZ625 connected	100 titles
CDC655Tz connected	100 titles

1. Press the [SRC] button to select the mode you want to enter a title (Radio, CD, CD changer or TV).
2. Play a track or tune in to a radio/TV station for which you want to enter the title.
3. Do one of the following:

#### ● In the CD or CD changer mode:

Press the [TITLE] button to select “USER TITL”.

#### ● In the radio or TV mode:

Skip this step.

4. Press and hold the [TITLE] button for 1 second or longer to switch to the title input display.
5. Move the [◀] / [▶] lever to move the cursor.
6. Press the [BND] button to select a character. Each time you press the [BND] button, the character changes in the following order:  
**Capital letters → Numbers → Symbols → Umlaut → Capital letters...**
7. Turn the [ROTARY] knob to select the desired character.
8. Repeat steps 5 to 7 to enter up to 8 characters for the title.
9. Press and hold the [▶|||] button for 2 seconds or longer to store the title into memory and return to the previous mode.

## **Clearing titles**

1. Play a track or tune in to a radio/TV station for which you want to delete the title.
2. Do one of the following:
  - **In the CD or CD changer mode:**  
Press the [TITLE] button to select "USER TITL".
  - **In the radio or TV mode:**  
Skip this step.
3. Press and hold the [TITLE] button for 1 second or longer to switch to the title input display.
4. Press and hold the [BND] button for 1 second or longer to delete the title.
5. Press and hold the [▶|||] button for 2 seconds or longer to store the setting and return to the previous mode.

## **Cellular telephone mute**

This unit requires special wiring to mute the audio signal automatically when a cellular telephone rings in the car.

- This function is not compatible with all cellular telephones. Contact your local authorized Clarion dealer for information on proper installation and compatibility.

## **AUX function**

This system has an external input jack so you can listen to audio from an external device connected to this unit.

# 9. OPERATIONS OF ACCESSORIES

## CD Changer Operations

### CD changer functions

When an optional CD changer is connected through the CeNET cable, this unit controls all CD changer functions. This unit can control a total of 2 changers.

1. Press the [SRC] button and select the CD changer mode to start play.
  2. If 2 CD changers are connected, press the [SRC] button to select the CD changer for play.
- If “NO MAG” appears in the display, insert the magazine into the CD changer. “DISC CHK” appears in the display while the player loads (checks) the magazine.
  - If “NO DISC” appears in the display, eject the magazine and insert discs into each slot. Then, reinsert the magazine back into the CD changer.

#### Note:

- Some CDs recorded in CD-R/CD-RW mode may not be usable.

### CAUTION

CD-ROM discs cannot be played from every CD changer, it's depended on the model.

### Pausing play

1. Press the [▶||] button to pause play. “PAUSE” appears in the display.
2. To resume play, press the [▶||] button again.

### Displaying CD titles

This unit can display title data for CD-text CDs and user titles input with this unit.

#### ●When connected to CDC655Tz or DCZ625

1. Each time you press the [TITLE] button, the title changes in the following order:

User title (disc) → CD-text title (disc) →  
Artist name → CD-text title (track) → User  
title (disc)...

#### Notes:

- If the CD playing is not a CD-text CD or no user title has been input, “NO TITLE” appears in the display.

- If a CD-text CD is not input its disc title or a track title, “NO TITLE” appears in the display.

### Procedure to scroll a title

Set “AUTO SCROL” to “ON” or “OFF”.

(The factory default setting is “ON”. Refer to the subsection “Setting the method for title scroll” (P. 41) in section “Common Operations”.)

#### ●When set to “ON”

The title is automatically kept scrolling.

#### ●When set to “OFF”

To scroll just 1 time when the title was changed or you press and hold the [TITLE] button for 1 second or longer.

### Selecting a CD

1. Press the [UP] or [DN] button to select the desired disc.
- If a CD is not loaded in a slot of magazine, pressing the [UP] or [DN] button can not work.
  - Pressing the [BND] button also advances to next disc.

### Skipping a track

#### ●Track-up

1. Move the [◀] / [▶] lever up to move ahead to the beginning of the next track.

#### ●Track-down

1. Move the [◀] / [▶] lever down to move back to the beginning of the current track.
2. Move the lever down again within about 2 seconds to move to the beginning of the previous track.

### Fast-forward/fast-rewind

#### ●Fast-forward

1. Move the [◀◀] / [▶▶] lever up for 1 second or longer.

#### ●Fast-rewind

1. Move the [◀◀] / [▶▶] lever down for 1 second or longer.

**Scan play**

Scan play locates and plays the first 10 seconds of each track on a disc automatically. This function continues on the disc until it is cancelled.

- The scan play is useful when you want to select a desired track.
1. Press the **[SCN]** button.
  2. To cancel the scan play, press the **[SCN]** button again.

**Disc scan play**

Disc scan play locates and plays the first 10 seconds of the first track on each disc in the currently selected CD changer. This function continues automatically until it is cancelled.

- Disc scan play is useful when you want to select a desired CD.
1. Press and hold the **[SCN]** button for 1 second or longer.
  2. To cancel disc scan play, press the **[SCN]** button again.

**Repeat play**

Repeat play continuously plays the current track. This function continues automatically until it is cancelled.

1. Press the **[RPT]** button.
2. To cancel repeat play, press the **[RPT]** button again.

**Disc repeat play**

After all the tracks on the current disc have been played, disc repeat play automatically replays the current disc over from the first track. This function continues automatically until it is cancelled.

1. Press and hold the **[RPT]** button for 1 second or longer.
2. To cancel disc repeat play, press the **[RPT]** button again.

**Random play**

Random play selects and plays individual tracks on the disc in no particular order. This function continues automatically until it is cancelled.

1. Press the **[RDM]** button.
2. To cancel random play, press the **[RDM]** button again.

**Disc random play**

The disc random play selects and plays individual tracks or discs automatically in no particular order. This function continues automatically until it is cancelled.

1. Press and hold the **[RDM]** button for 1 second or longer.
2. To cancel disc random play, press the **[RDM]** button again.

## TV Operations

### TV tuner functions

When an optional TV tuner is connected through the CeNET cable, this unit controls all TV tuner functions. To watch TV it requires a TV tuner and a monitor.

#### Watching a TV

1. Press the **[SRC]** button and select the TV mode.
2. Press the **[BND]** button to select the desired TV band (TV1 or TV2). Each time the button is pressed, the input selection toggles between TV1 and TV2.
3. Move the [**◀**] / [**▶**] lever to tune in the desired TV station.

#### Watching a video

The TV tuner features a VTR input for an external A/V source, such as a game station.

1. Press and hold the **[ADJ]** button for 1 second or longer to select VTR.
2. To return to the TV broadcast, press and hold the **[ADJ]** button for 1 second or longer.

#### TV tuning

There are 3 types of TV tuning modes available, seek, manual and preset tuning.

#### Seek tuning

1. Press the **[BND]** button and select the desired TV band (TV1 or TV2).
  - If **"MANU"** is lit in the display, press and hold the **[BND]** button for 1 second or longer. **"MANU"** in the display goes off and seek tuning is now available.
2. Move the [**◀**] / [**▶**] lever to automatically seek a station. Move the lever up to automatically tune up the frequency band to the next available TV station; move the lever down to automatically tune down.

#### Manual tuning

There are 2 ways available: Quick tuning and step tuning.

When you are in the step tuning mode, the frequency changes one step at a time. In the quick tuning mode, you can quickly tune the desired frequency.

1. Press the **[BND]** button and select the desired band (TV1 or TV2).
  - If **"MANU"** is not lit in the display, press and hold the **[BND]** button for 1 second or longer. **"MANU"** lights in the display and manual tuning is now available.
2. Tune into a station.

#### ● Quick tuning:

1. Move the [**◀**] / [**▶**] lever for 1 second or longer to tune in a station.

#### ● Step tuning:

1. Move the [**◀**] / [**▶**] lever to manually tune in a station.

#### Recalling a preset station

A total of 12 TV stations can be stored (6-TV1 and 6-TV2). This allows you to select your favorite TV stations and store them in memory.

1. Press the **[BND]** button and select the desired TV band (TV1 or TV2).
2. To recall a stored TV station, press the desired **[DIRECT]** button to select that station.
  - Press and hold one of the **[DIRECT]** buttons for 2 seconds or longer to store the current station into preset memory.

#### Manual memory

1. Select the desired station with seek tuning, manual tuning or preset tuning.
2. Press and hold one of **[DIRECT]** buttons for 2 seconds or longer to store the current station into preset memory.

## Auto store

Auto store selects 6 TV stations automatically and stores each one into preset memory.

If the 6 stations with good reception are not available, stations previously stored in memory remain. Only stations with strong reception are stored into memory.

1. Press the **[BND]** button and select the desired TV band (TV1 or TV2).
2. Press and hold the **[PS/AS]** button for 2 seconds or longer. The stations with good reception are stored automatically to the preset channels.

## Preset scan

Preset scan allows the user to view each preset position before it automatically advances to the next preset. This function is useful for searching for a desired TV station in memory.

1. Press the **[PS/AS]** button.
2. When the desired station is found, press the **[PS/AS]** button again to remain tuned to that station.

### Note:

- Do not press and hold the **[PS/AS]** button for 2 seconds or longer. Doing so will trigger the auto store function and start storing stations into memory.

## Setting the TV area

When you select the TV area (TV reception area), the TV tuner area setting changes.

1. Press the **[ADJ]** button to switch to the adjust mode.
  2. Move the **[◀] / [▶]** lever to select **"TV AREA"**.
  3. Press the **[▶||]** button.
  4. Turn the **[ROTARY]** knob to select the reception area.
  5. Press the **[▶||]** button.
  6. Press the **[ADJ]** button to return to the previous mode.
- The above operations are required when a TV tuner other than TTX7501z is connected.

## Setting the TV diver

You can change the reception setting for the TV antenna connected to the TV tuner.

- The factory default setting is **"ON"**.
1. Press the **[ADJ]** button to switch to the adjust mode.
  2. Move the **[◀] / [▶]** lever to select **"TV DIVER"**.
  3. Turn the **[ROTARY]** knob to select **"ON"** or **"OFF"**.

### ● ON:

Sets the diver setting to ON.

### ● OFF:

Sets the diver setting to OFF.

4. Press the **[ADJ]** button to return to the previous mode.

# 10. TROUBLE SHOOTING

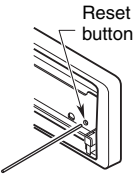
	Problem	Cause	Measure
General	Power does not turn on. (No sound is produced.)	Fuse is blown.	Replace with a fuse of the same amperage. If the fuse blows again, consult Clarion dealer.
		Incorrect wiring.	Consult Clarion dealer.
	No audio when operating the unit with amplifiers.	Amplifier turn-on lead is shorted to ground or excessive current is required.	Turn the unit off and check each wire for a possible short. If the amplifier turn-on lead shorts out, cover it with insulation such as tape.
	Nothing happens when buttons are pressed.	The microprocessor has malfunctioned due to noise, etc.	Turn off the power, then press the [ <b>OPEN</b> ] button and remove the DCP. Press the reset button for about 2 seconds with a thin rod. 
	Display is not accurate.	DCP or main unit connectors are dirty.	Wipe the dirt off with a soft cloth moistened with cleaning alcohol.
	No audio.	The speaker protection circuit is operating.	<ol style="list-style-type: none"> <li>1. Check the speaker connection.</li> <li>2. Turn down sound volume. Function can also be restored by turning the power off and on again.</li> <li>3. If the sound is muted again, consult Clarion dealer.</li> </ol>
DVD (CD/MP3/WMA)	No audio.	MP3/WMA files are absent on the disc.	Write MP3/WMA files onto the disc properly.
		Files are not recognized as an MP3/WMA file.	Use MP3/WMA files encoded properly.
		File system is not correct.	Use ISO9660 level 1, 2 or JOLIET or Romeo file system.
	Sound skips or is noisy.	Disc is dirty.	Clean the disc with a soft cloth.
		Disc is heavily scratched or warped.	Replace with a disc with no scratches.
	Sound is cut or skipped. Noise is generated or noise is mixed with sound.	MP3/WMA files are not encoded properly.	Use MP3/WMA files encoded properly.
	Poor sound quality in extremely cold weather or extreme humidity.	Water droplets may form on the internal lens when the car is parked in a humid place.	Let dry for about 1 hour with the power on.
	Wrong filename	File system is not correct.	Use ISO9660 level 1, 2 or JOLIET or Romeo file system.
	DVD sound decreased when the system check/speaker setting was changed to "5.1ch" in a 4-speaker configuration.	The " <b>SPEAKER-SEL</b> " center speaker and sub-woofer settings are " <b>ON</b> ".	When the speaker setting is " <b>5.1ch</b> ", connect the center speaker and sub-woofer. When speakers are not available, be sure to set the corresponding speakers to " <b>OFF</b> " at " <b>SPEAKER-SEL</b> " (P. 36).



# 11.ERROR DISPLAYS

If an error occurs, one of the following displays is displayed.  
Take the measures described below to eliminate the problem.

	Error Display	Cause	Measure
DVD (CD/MP3/WMA)	ERROR 2	A DISC is caught inside the DVD deck and is not ejected.	This is a failure of DVD deck's mechanism and consult Clarion dealer.
	ERROR 3	A DISC cannot be played due to scratches, etc.	Replace with a non-scratched disc.
	ERROR 6	A DISC is loaded upside-down inside the DVD deck and cannot play.	Eject the disc then reload it properly.
	ERROR P	Parental level error	Set the correct Parental level.
	ERROR R	Region code error	Eject the disc and replace correct region code disc.
	DRM	Playback stops because WMA files protected by DRM are played.	Perform the operation such as skipping a file.
NOT SPRT	Playback stops because MP3/WMA bit rate is out of range which this unit supports. (Scan/repeat/random playback will be canceled.)		
CD changer	ERROR 2	A DISC inside the CD changer is not loaded properly.	This is a failure of CD changer's mechanism and consult Clarion dealer.
	ERROR 3	A DISC inside the CD changer cannot be played due to scratches, etc.	Replace with a non-scratched disc.
	ERROR 6	A DISC inside the CD changer cannot be played because it is loaded upside-down.	Eject the disc then reload it properly.

If an error display other than the ones described above appears, press the reset button. If the problem persists, turn off the power and consult Clarion dealer.

# 12.SPECIFICATIONS

## **FM Tuner**

### **Frequency Range:**

87.0 MHz to 108.0 MHz

### **Usable Sensitivity:**

9 dBf

### **50dB Quieting Sensitivity:**

15 dBf

### **Alternate Channel Selectivity:**

70 dB

### **Stereo Separation (1 kHz):**

35 dB

### **Frequency Response ( $\pm 3$ dB):**

30 Hz to 15 kHz

## **AM Tuner**

### **Frequency Range:**

531 kHz to 1629 kHz

### **Usable Sensitivity:**

25  $\mu$ V

## **DVD Player section**

### **System:**

Digital Versatile Disc System with CDDA capable

### **Usable Discs:**

DVD Video Disc, Video CD, Compact disc

### **Frequency Response ( $\pm 1$ dB):**

20 Hz to 22 kHz

### **Signal to Noise Ratio (1 kHz):**

100 dB

### **Distortion:**

0.01%

### **Channel Separation (1 kHz):**

80 dB

### **Analog audio output:**

2.0 Vrms

## **Audio**

### **Maximum Power Output:**

208 W (52 W  $\times$  4 ch)

### **Continuous Average Power Output:**

17 W  $\times$  4, into 4  $\Omega$ , 20 Hz to 20 kHz, 1%THD

### **Bass Control Action (50 Hz/80 Hz/120 Hz):**

+16 dB, -12dB

### **Treble Control Action (8 kHz/12 kHz):**

$\pm 12$  dB

### **Line Output Level (CD 1 kHz):**

1.8 V

## **General**

### **Power Supply Voltage:**

14.4 V DC (10.8 to 15.6 V allowable), negative ground

### **Current Consumption:**

Less than 15 A, 3A

### **Speaker Impedance:**

4  $\Omega$  (4  $\Omega$  to 8  $\Omega$  allowable)

### **Weight / Source unit:**

3.3 lb. (1.5 kg)

### **Weight / Remote control unit:**

3.5 oz. (100g) (including battery)

### **Dimensions / Source unit:**

7" (Width)  $\times$  2" (Height)  $\times$  6-5/16" (Depth)

[178 (W)  $\times$  50 (H)  $\times$  160 (D) mm]

### **Dimensions / Remote control unit:**

2-1/8" (Width)  $\times$  6-1/8" (Height)  $\times$  1-1/16" (Depth)

[54 (W)  $\times$  155 (H)  $\times$  27 (D) mm]

### **Note:**

- Specifications and design are subject to change without notice for further improvement.



# Clarion Co., Ltd.

---

2006/1

All Rights Reserved. Copyright © 2006: Clarion Co., Ltd.

PE-2707K  
280-8329-00