

clarion®

Owner's manual & Installation manual
Mode d'emploi et manuel d'installation
Manual de instrucciones y de instalación

VRX785BT

**DVD MULTIMEDIA STATION WITH CeNET & 7-inch
TOUCH PANEL CONTROL**
**STATION MULTIMEDIA DVD AVEC COMMANDE
PAR ECRAN TACTILE 7 pouces & CeNET**
**EQUIPO DVD MULTIMEDIA CON CeNET Y PANEL
DE CONTROL TÁCTIL DE 7 pulgadas**

CLARION PRODUCT REGISTRATION INFORMATION

For USA and Canada only
www.clarion.com

Dear Customer:

Congratulations on your purchase of a Clarion mobile electronic product. We are confident that you'll enjoy your Clarion experience.

There are many benefits to registering your product. We invite you to visit our website at www.clarion.com to register your Clarion product.

We have made product registration simple with our easy to use website. The registration form is short and easy to complete. Once you're registered, we can keep you informed of important product information.

Register at www.clarion.com - it's easy to keep your Clarion product up to date.

INFORMATIONS DE L'ENREGISTREMENT DE PRODUITS CLARION

Pour les États Unis et le Canada seulement
www.clarion.com

Cher client:

Nous vous remercions d'avoir acheté ce produit électronique mobile Clarion. Nous sommes confiants que vous apprécierez votre expérience Clarion.

Il y a beaucoup d'avantage à enregistrer votre produits. Nous vous invitons à visiter notre site Web www.clarion.com pour enregistrer votre produit Clarion.

Nous avons facilité la tâche d'enregistrement de produit simple et facile grâce à notre site Web. Le formulaire d'enregistrement est court et facile à compléter. Lorsque vous êtes enregistré, nous pouvons vous tenir informé des informations important de produits.

Enregistrer à www.clarion.com - c'est facile de mettre à jour votre produit Clarion.

INFORMACIÓN DEL REGISTRO DE PRODUCTO DE CLARION

Para USA y Canada nomas
www.clarion.com

Querido Cliente:

Felicitaciones por su compra de producto electrónico móvil de Clarion. Estamos seguros que usted gozará de su experiencia con el producto de Clarion.

Hay muchas ventajas al registrar su producto. Le invitamos a que visite nuestro sitio en internet www.clarion.com para registrar su producto de Clarion.

Hemos hecho el registro de producto fácil en nuestro sitio. La forma de registro es corta y fácil de completar. Una vez que lo registre, podremos proporcionarle la información de su producto.

Regístrese en www.clarion.com - es fácil mantener su producto de Clarion actualizado.

Thank you for purchasing the Clarion **VRX785BT**.

- Please read this owner's manual thoroughly before operating this equipment.
- After reading this manual, be sure to keep it in a handy place (e.g., glove compartment).
- Check the contents of the enclosed warranty card and keep it carefully with this manual.

Contents

1. FEATURES	2
Expanding Systems.....	2
Playable discs	3
DVD video features	4
2. PRECAUTIONS	5
Liquid crystal panel/Generalities.....	6
Cleaning	6
About the registered marks, etc.	7
3. CONTROLS	8
Functions of Buttons.....	8
Outline of Button and Touchkey Operation	10
Remote Control Unit.....	16
4. BASIC OPERATIONS	18
DCP (Detachable Control Panel).....	18
Turning On and Off the Power	19
Adjusting the Volume	19
Opening the Liquid Crystal Panel and Adjusting the Angle.....	19
Turning the Audio OFF.....	21
Turning the Monitor OFF	21
Setting/Ejecting a Disc	21
Connecting/Disconnecting an USB Media Device.....	23
Selecting a Media Source	25
2Zone Function	26
5. SOURCE OPERATIONS	27
Radio Operations	27
DVD Video Operations	29
Audio CD Operations	35
MP3/WMA/AAC Operations	37
DivX Operations	40
6. SOURCE OPERATIONS (ACCESSORIES)	42
XM Satellite Radio Operations	42
iPod Operations.....	45
MTP Audio Player Operations.....	49
USB Memory Operations.....	50
Bluetooth Audio Player Operations	51
Bluetooth Telephone Operations.....	53
Navigation System Operations.....	57
AUX Operations	58
7. SYSTEM SETTINGS	59
Audio Settings	59
General Settings.....	62
Adjusting the Monitor.....	64
8. TROUBLESHOOTING	65
9. ERROR DISPLAYS	67
10. SPECIFICATIONS	69
INSTALLATION AND WIRE CONNECTION MANUAL	70

1. FEATURES

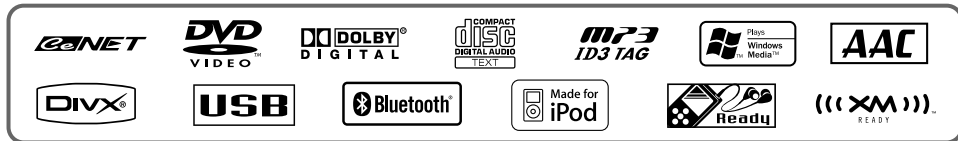

- Built in Bluetooth® Handsfree (HFP & OPP) and Audio Streaming (A2DP & AVRCP)
- USB direct connection for iPod® & Digital Media
- NAX980HD/NAX970HD (HDD Navigation) control with Touch Panel

Expanding Systems

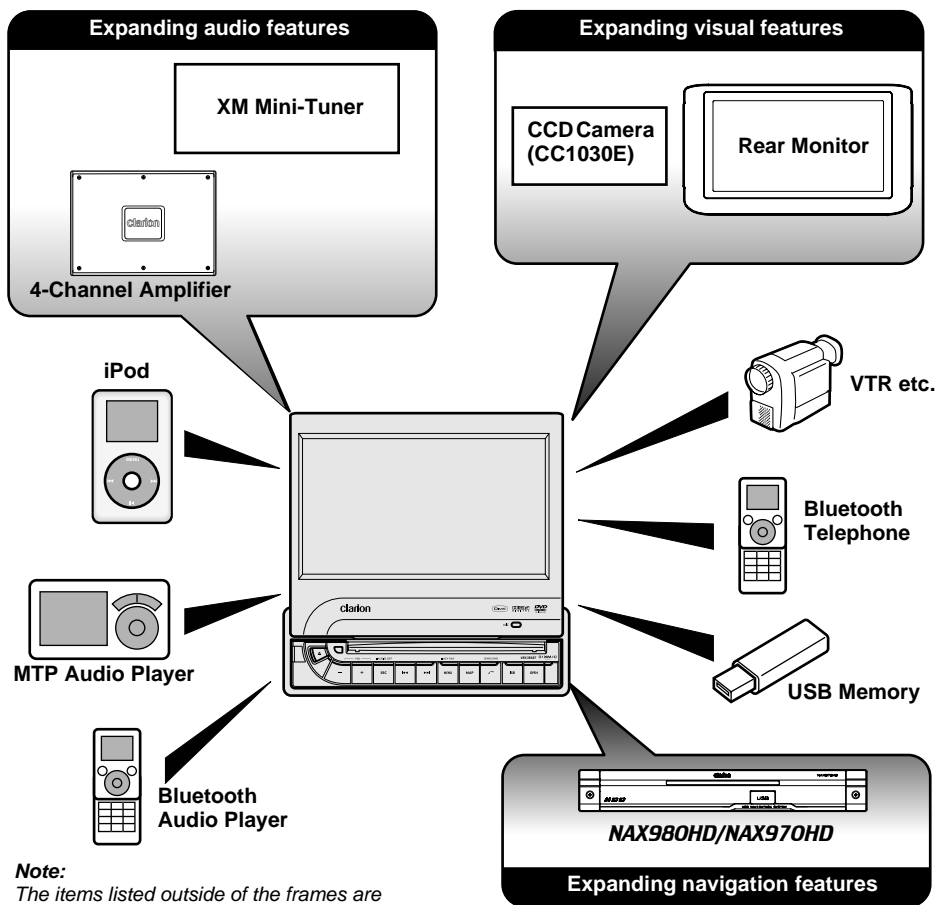

Playable discs

This DVD player can play the following discs:



In addition, the DVD player can play CD-R/RW, DVD-R/RW, and DVD+R/RW discs on which the following media files have been recorded:

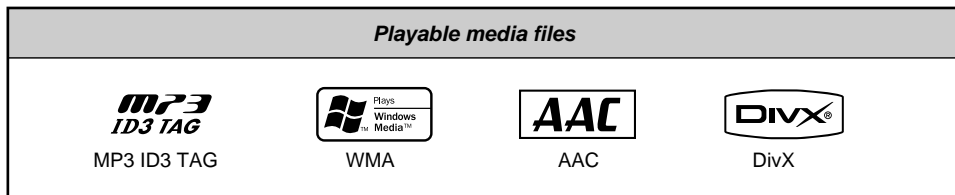

For detailed information, see the sections entitled “MP3/WMA/AAC Operations” (page 37) and “DivX Operations” (page 40).

About CD Extra discs

A CD Extra disc is a disc in which a total of two sessions have been recorded. The first session is Audio session and the second session is Data session.

Your personally-created CDs with more than second data sessions recorded cannot be played on this DVD player.

Note:

- When you play a CD Extra disc, only the first session will be recognized.

About playing a CD-R/RW disc

This player can play CD-R/RW discs previously recorded in Audio CD format or format with MP3/WMA/AAC/DivX files.

About playing a DVD-R/RW or DVD+R/RW disc

This player can play DVD-R/RW and DVD+R/RW discs previously recorded in DVD video format or format with MP3/WMA/AAC/DivX files.

Discs that cannot be played back

This player cannot play DVD Audio, DVD-RAM, Video CDs, Photo CDs, etc.

Note:

- It may not be possible to play back discs recorded on some CD/DVD drive units. (Cause: disc characteristics, cracks, dust/dirt, dust/dirt on player's lens, etc.)
- If a CD-R/RW, DVD-R/RW, or DVD+R/RW disc that has not been finalized is played, it will take a long time to start playing. Also, it may not be possible to play depending on its recording conditions.
- You cannot play Super Audio CDs. Playback of the CD player is not supported even if it is a hybrid disc.

Note on region numbers of DVD video discs

The DVD video system assigns a region number to DVD players and DVD discs by sales area. The DVD video region number playable in this system is marked on the disc jacket as shown below.



DVD video features

This unit provides the following functions in addition to the high image quality and sound quality of DVD video.

Note:

- The functions described in this section differ depending on the DVD video disc. Refer to the instructions provided with the DVD video.
- Some disc functions may operate differently from described in this manual.

Multi-sound function

DVD video can store up to 8 languages for one film; select the language of your preference.

- The languages stored on the disc are indicated by the icon shown below.

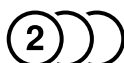

Multi-angle function

A DVD video that is filmed from multiple angles allows you to select the angle of choice.

- The number of recorded angles is indicated by the icon shown below.

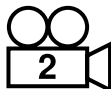

Subpicture (subtitles) function

A DVD video can record subtitles for up to 32 languages and you can select the language of the subtitles you wish to see.

- The number of recorded subtitle languages is indicated by the icon shown below.

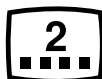

Multi-story function

When a DVD video contains more than one story for a film, you can select the story you wish to enjoy. The operation procedures vary with the disc; observe the instructions for selecting a story provided during playback.

DVD menu

DVD Menus can be called up during DVD video playback to perform menu setting.

- Example showing DVD menu



Liquid crystal panel/Generalities

For a longer service life, be sure to read the following cautions.

- Be sure to house the liquid crystal panel inside the main unit when parking the car outdoors for a long period of time. The liquid crystal panel will operate properly in a temperature range of 0 to 60°C.
- Do not allow any liquids on the set from drinks, umbrellas, etc. Doing so may damage the internal circuitry.
- Do not disassemble or modify the set in any way. Doing so may result in damage.
- Do not draw the liquid crystal panel out and use it as a tray. Also, subjecting the liquid crystal panel to shocks may result in breakage, deformation, or other damage.
- Do not let cigarettes burn the display. Doing so may damage or deform the cabinet.
- If a problem should occur, have the set inspected at your store of purchase.
- Do not insert objects or poke in the space between the liquid crystal panel and the main unit when the panel is tilted.
- Do not place anything on the display when the panel is tilted.
- The remote control unit may not work if the remote control sensor is exposed to direct sunlight.
- In extremely cold weather, the display movement may slow down and the display may darken, but this is not a malfunction. The display will work normally when the temperature increases.
- Small black and shiny spots inside the liquid crystal panel are normal for LCD products.
- The liquid crystal panel may stop temporarily when it opens or closes, when the engine stops or when it is cold.
- The touchkeys on the display operate when slightly touched. Do not press the touchkey screen with much force.
- Do not push the case surrounding the touchkey panel with much force. This may cause malfunctioning of the touchkeys.

Cleaning

• Cleaning the cabinet

Use a soft and dry cloth and gently wipe off the dirt. For tough dirt, apply some neutral detergent diluted in water to a soft cloth, wipe off the dirt gently, then wipe again with a dry cloth.

Do not use benzene, thinner, car cleaner, etc., as these substances may damage the cabinet or cause the paint to peel. Also, leaving rubber or plastic products in contact with the cabinet for long periods of time may cause stains.

• Cleaning the liquid crystal panel

The liquid crystal panel tends to collect dust, so wipe it off occasionally with a soft cloth. The surface is easily scratched, so do not rub it with hard objects.

About the registered marks, etc.

- This product incorporates copyright protection technology that is protected by U.S. patents and other intellectual property rights. Use of this copyright protection technology must be authorized by Macrovision, and is intended for home and other limited viewing uses only unless otherwise authorized by Macrovision. Reverse engineering or disassembly is prohibited.
- Manufactured under license from Dolby Laboratories.
“**Dolby**” and the double-D symbol are trademarks of Dolby Laboratories.
- Windows Media™, and the Windows® logo are trademarks, or registered trademarks of Microsoft Corporation in the United States and/or other countries.
- “**DivX**”, “**DivX Certified**”, and associated logos are trademarks of DivX, Inc., and are used under license.
- XM and the XM logos are trademarks of XM Satellite Radio Inc.
- iPod is for legal or rightholder-authorized copying only. Don’t steal music.
“**iPod**” is a trademark of Apple Inc., registered in the U.S. and other countries.

WMDRM 10 for devices

- This product is protected by certain intellectual property rights of Microsoft. Use or distribution of such technology outside of this product is prohibited without a license from Microsoft.
- Content owners use Windows Media digital rights management technology (WMDRM) to protect their intellectual property, including copyrights. This device uses WMDRM software to access WMDRM-protected content. If the WMDRM software fails to protect the content, content owners may ask Microsoft to revoke the software’s ability to use WMDRM to play or copy protected content. Revocation does not affect unprotected content. When you download licenses for protected content, you agree that Microsoft may include a revocation list with the licenses. Content owners may require you to upgrade WMDRM to access their content. If you decline an upgrade, you will not be able to access content that requires the upgrade.

3. CONTROLS

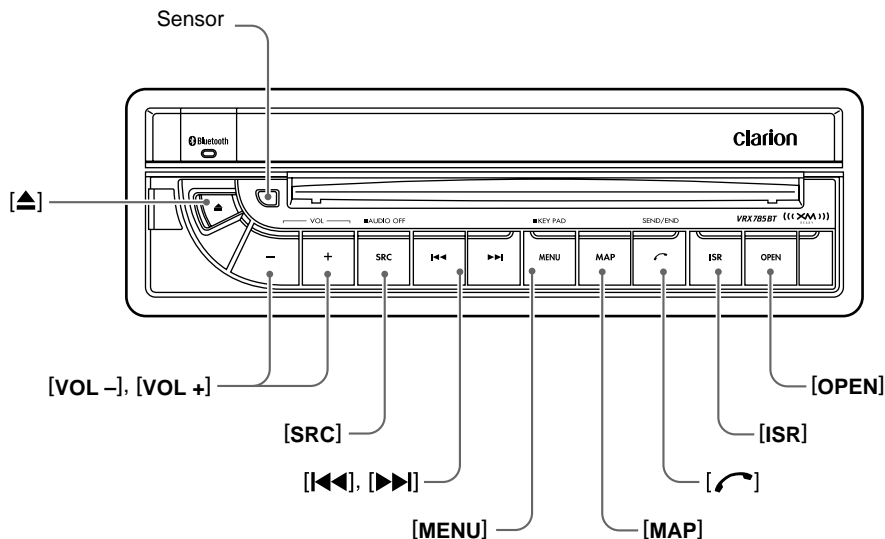

Note:

The control panel can be detached to prevent theft. For details, see the pages of "DCP (Detachable Control Panel)" (page 18).

Functions of Buttons

Note:

• Be sure to read this section while referring to the front diagram.

Sensor

• Receiver for the remote control unit (operating range: 30° in all directions).

[▲] (EJECT) button

• Use this button to eject the disc set in this unit.

[VOL -], [VOL +] buttons

• Use these buttons to increase/decrease the volume.

[SRC] button

- When the liquid crystal panel is closed, press this button to change to the next source mode such as TUNER mode.
- When the liquid crystal panel is open, press this button to display the Source screen to switch the source mode.
- Keep pressing this button more than 1 second to turn off the audio feature (AUDIO OFF). Press this button to turn on the audio feature.

[◀▶], [▶▶] buttons

• Use these buttons to change to the previous/next preset station in the TUNER and XM modes.

- In the DVD Video mode, use these buttons to select a chapter to be played. Keep pressing a button during playback performs the fast backward or fast forward playback. Keep pressing the [▶▶] button during pausing performs the slow playback.
- In the CDDA, MP3/WMA/AAC/DivX, and iPod/MTP Audio Player/USB Memory/Bluetooth (Audio) modes, use these buttons to select a track to be played. Keep pressing a button during playback performs the fast backward or fast forward playback.

[MENU] button*1

- Press this button to display the Menu screen. You can change the system settings from this screen.
- While playing a DVD video, keep pressing this button more than 1 second to display the Key Pad on the screen. You can operate the DVD menu using the Key Pad.

[MAP] button*2

- Pressing this button in the audio/visual modes changes to the Navigation mode.

[↶] (SEND/END) button*3

- When a call comes in, press this button to answer the call.
- During a call, press this button to end the call.

[ISR] button

- Keep pressing this button more than 2 seconds in the TUNER mode stores the current station into ISR (Instant Station Recall) memory.
- Press this button in any mode to enter/exit the ISR mode.

[OPEN] button

- Use this button to open/close the liquid crystal panel.
- Keep pressing this button more than 2 seconds so that the liquid crystal panel is positioned horizontally when the liquid crystal panel is open (Air Conditioner Operation mode).
- When the liquid crystal panel is closed, keep pressing this button more than 5 seconds to perform the panel calibration function to memorize the maximum angle of the liquid crystal panel.

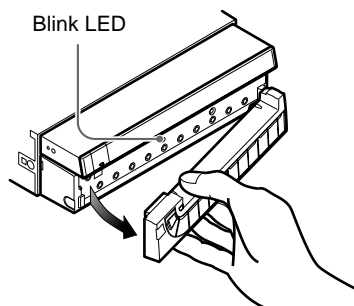

Blink LED

- When the Blink LED function is set to "ON" from the System tab menu on the General Settings screen, blinks when the DCP (Detachable Control Panel) is removed.

Note:

- *1 This button does not work when the liquid crystal panel is closed.
- *2 This button is available only when a navigation system is connected.
- *3 This button is available only when the connection with a Bluetooth telephone is established.

Outline of Button and Touchkey Operation

Turning the power on

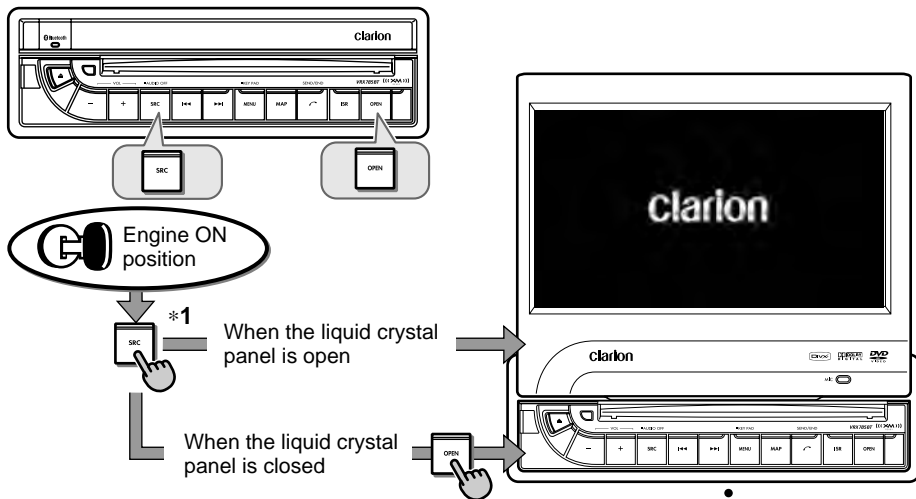

System check

The CeNET format utilized on this unit is provided with a system check function. When the system check function is performed under the following conditions, the power is automatically turned off. Press the **[SRC]** button again.

- When power is first turned on after initial installation.
- When an external device is connected or disconnected.
- When Reset button is pressed.

* In addition to the above conditions, the system check function can be performed from the System tab menu on the General settings screen.

Note:

*1 These images indicate the buttons to press or keys to touch.

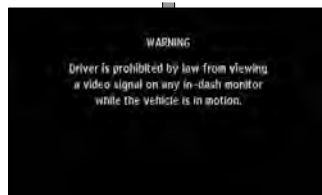

You can change the media sources.

TUNER mode operation

(Source screen)

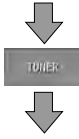

Switches the radio band.

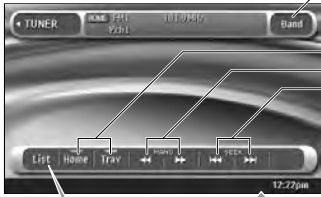

— Selects Home/Travel modes.
— Manual tuning
— Seek tuning



(Preset List screen)



- Select desired station after selecting radio band.

Outline of Button and Touchkey Operation

DVD Video mode operation

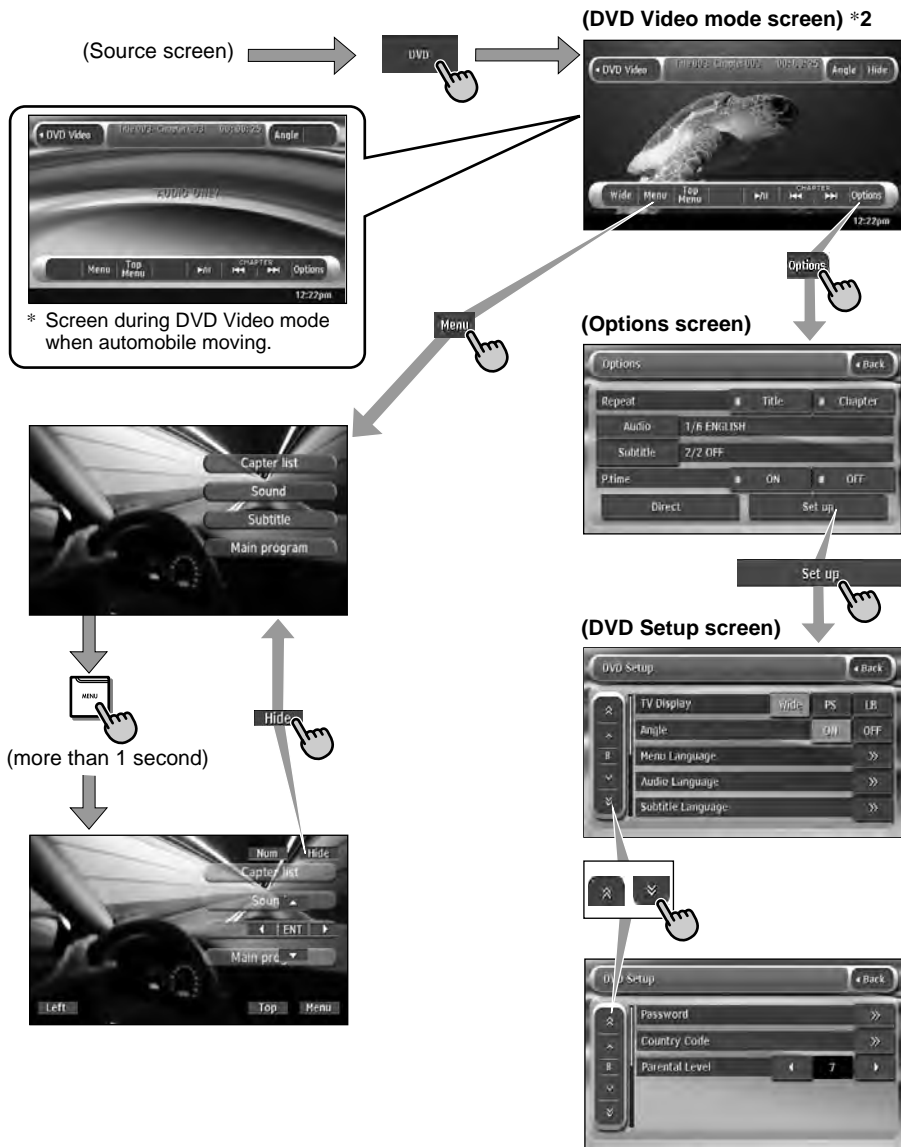

* Screen during DVD Video mode when automobile moving.

(more than 1 second)

Note:

*2 When playing a DVD video movie, touching the screen surface will cause the DVD Video mode screen to be displayed.

Bluetooth telephone operation

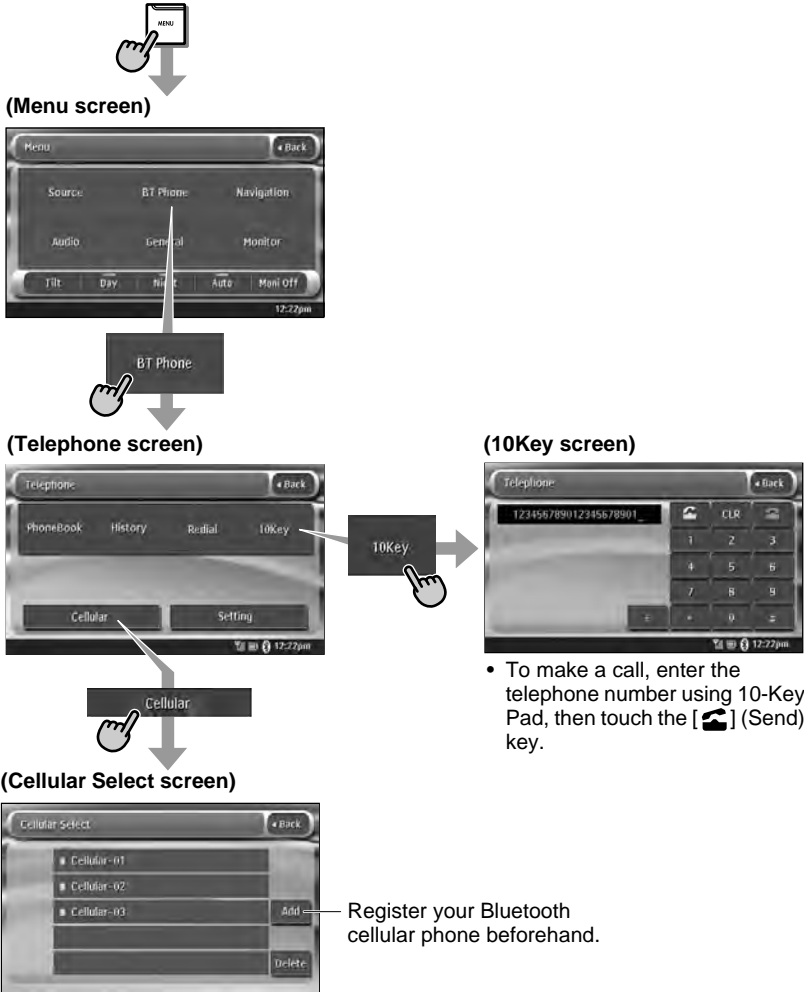

- To make a call, enter the telephone number using 10-Key Pad, then touch the [Send] (Send) key.

Register your Bluetooth cellular phone beforehand.

- Touch your desired Telephone key to select the telephone to be used.

Outline of Button and Touchkey Operation

Adjusting the General settings

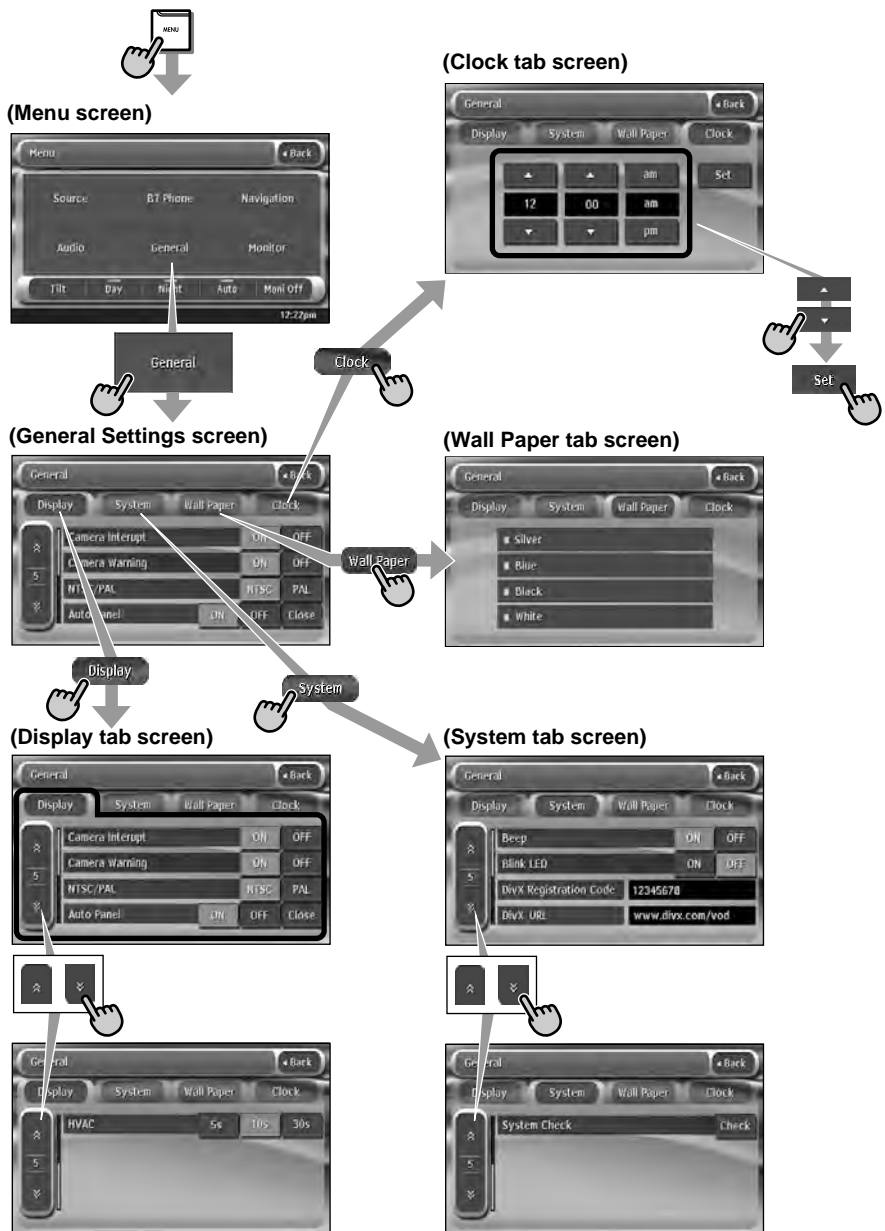

Adjusting the Audio settings

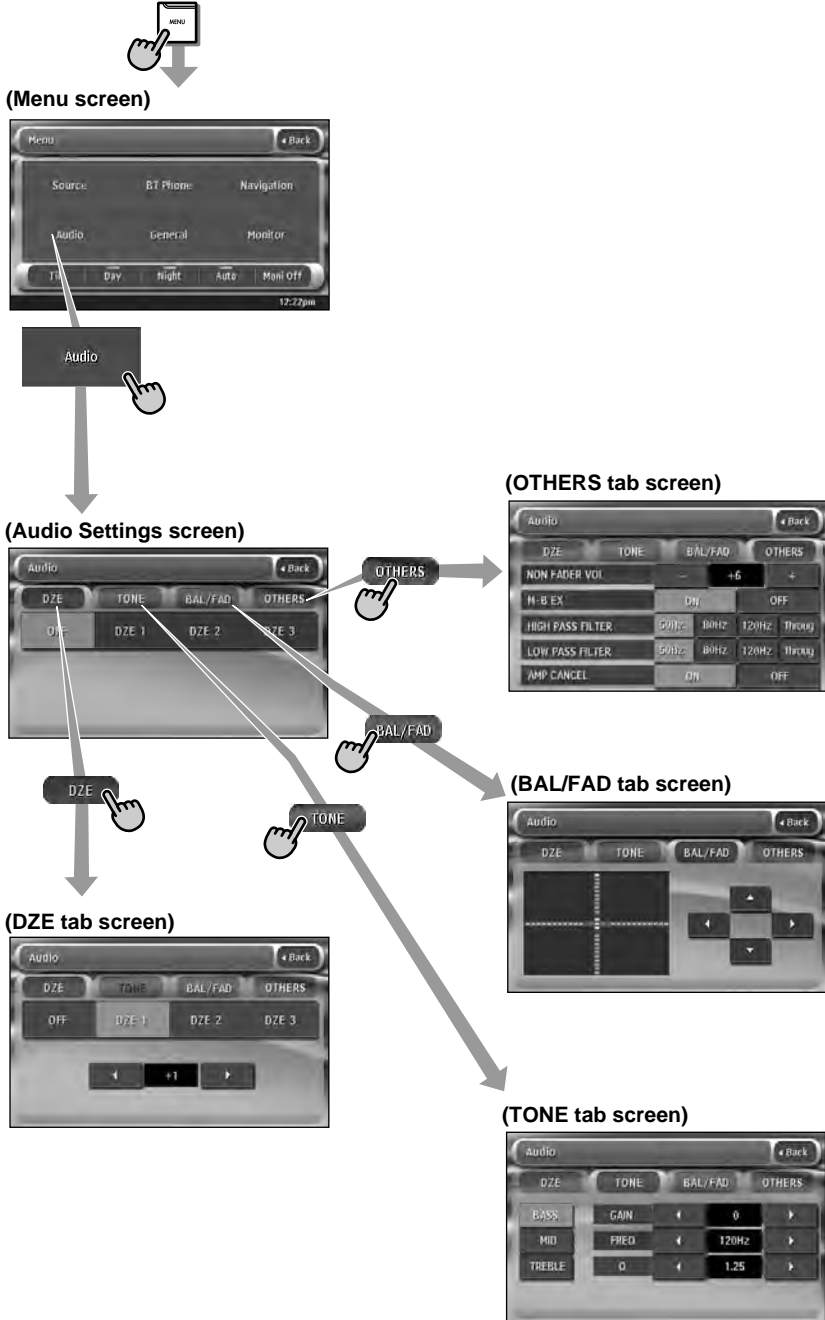

Remote Control Unit

Names of buttons

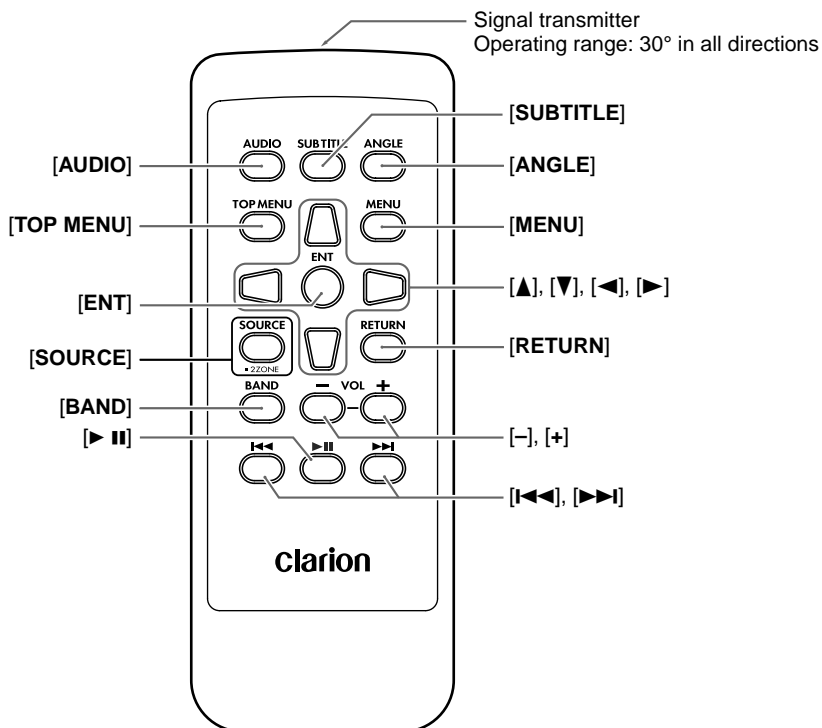

Inserting the Battery

1. Slide the rear cover in the direction of the arrow, and remove it.
2. Insert the CR2025 battery bundled with the remote control unit in the directions shown in the figure, then close the rear cover.

Note:

Using battery improperly can cause it to explode.

Take note of the following points:

- Do not short-circuit, disassemble or heat battery.
- Do not dispose of battery into fire or flames.
- Dispose of spent battery properly.

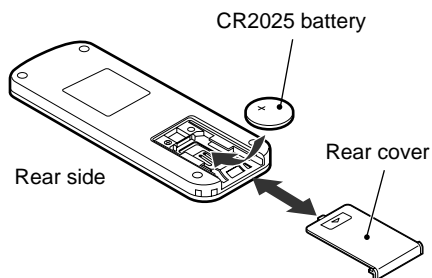

Functions of Remote Control Unit Buttons

You can use the remote control unit to control the VRX785BT. When the 2Zone function is ON, the controls work upon the Sub zone only.

Note:

- The steering wheel remote control operations work upon the Main zone even when the 2Zone function is ON.

[AUDIO] button

- Press to set the Audio language. (in DVD Video mode)

[SUB TITLE] button

- Press to display subtitles. (in DVD Video mode)

[ANGLE] button

- Press to set the Angle function of the DVD video when the Angle mark is displayed. (in DVD Video mode)

* Available only when the Angle function in the DVD Setup screen is set to "ON".

[TOP MENU] button

- Press to display the DVD top menu stored on the DVD video disc. Some discs are not displayed the DVD top menu. (in DVD Video mode)

[MENU] button

- Press to display the DVD menu stored on the DVD video disc. (in DVD Video mode)

[ENT] button

- Press to fix the selected menu item on the DVD menu. (in DVD Video mode)

[▲], [▼], [◀], [▶] buttons

- Press to select desired menu item displayed on the DVD menu. (in DVD Video mode)

[SOURCE] button

- Press to switch the source modes such as TUNER mode, DVD mode, etc. (in any mode)

* Only DVD, USB, and AUX modes are selectable when 2Zone ON.

- Keep pressing more than 1 second to turn the 2Zone function ON/OFF. (in any mode)

[RETURN] button

- Press to return to the previous screen while the DVD menu is being displayed. However, it may occur that this button operation dose not work on some discs. (in DVD Video mode)

[BAND] button

- Switches reception bands. (in TUNER and XM modes; disabled when 2Zone ON)
- Keep pressing more than 1 second to switch the Home/Travel modes. (in TUNER mode; disabled when 2Zone ON)
- Press to select the next higher folder. (in MP3/WMA/AAC/DivX, MTP audio player, and USB memory modes)

[VOL -], [VOL +] buttons

- Decreases or increases the volume. (in any mode; disabled when 2Zone ON)

[▶ II] button

- Press to play or pause video and audio media. (in DVD, USB, and Bluetooth modes; disabled in USB/Bluetooth modes when 2Zone ON)
- Keep pressing more than 1 second to stop video playback. (in DVD Video mode)

[◀◀], [▶▶] buttons

- Press to select the next lower or higher preset station. (in TUNER and XM modes; disabled when 2Zone ON)
- Press to select the next lower or higher chapter number. (in DVD Video mode)
- Press to select the next lower or higher track. (in CDDA, MP3/WMA/AAC/DivX, USB, and Bluetooth modes)
- Keep pressing to perform fast backward or fast forward playback. (in DVD, USB, and Bluetooth modes)

4. BASIC OPERATIONS

Note:

- Be sure to read this chapter referring to the chapter "3. CONTROLS" (page 8).

DCP (Detachable Control Panel)

The control panel can be detached to prevent theft. When detaching the control panel, store it in the DCP case to prevent scratches.

We recommend taking the DCP with you when leaving the car.

Removing the DCP

1. Keep pressing the [SRC] button more than 1 second to turn the Audio OFF.

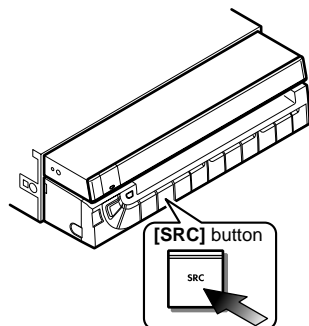

2. Pull the left side of the DCP toward you, and remove it.

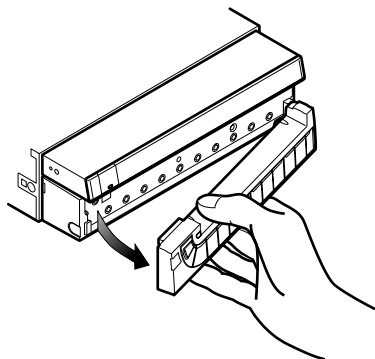

Attaching the DCP

1. Hook the right side of the DCP to the right side of the main unit.
2. Settle the left side of the DCP to the main unit.

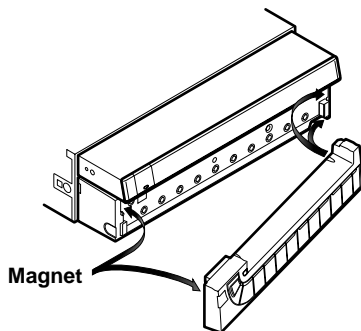

⚠ CAUTION

- This unit uses a magnet to fix the DCP. For the items that can be affected by magnetism, such as magnetic cards, be sure to keep them away from this unit.
- The DCP can easily be damaged by impact. After removing it be careful not to drop it nor subject it to strong impact.
- Remote control unit cannot be used when the DCP is removed.

Note:

- If the DCP is dirty, wipe it off by using a soft dry cloth.

⚠ CAUTION

When the Auto Panel function (see page 62) is set to "OFF", be sure to close the liquid crystal panel for safe before removing the DCP.

Turning On and Off the Power

⚠ CAUTION

When the unit is turned on, starting and stopping the engine with its volume raised to the maximum level may harm your hearings. Be careful about adjusting the volume.

Note:

- Start the engine before using this unit.
- Be careful about using this unit for a long time without running the engine. If you drain the car's battery too far, you may not be able to start the engine and this can reduce the service life of the battery.

1. Start the engine. The power is supplied to this unit.



2. Press the [SRC] button. The unit automatically memorizes its last operation mode and will automatically switch to display that mode.
3. To turn off the power, press and hold the [SRC] button for more than 1 second.
 - When Auto Panel is set to "ON" or "Close", the liquid crystal panel houses after the power turns off.

Adjusting the Volume

1. Press the [VOL -]/[VOL +] buttons to adjust the volume.
 - [VOL -]: Decreases the volume.
 - [VOL +]: Increases the volume.
 - The volume level indicated in the display is in a range from 0 (min.) to 33 (max.).

⚠ CAUTION

While driving, keep the volume level at which external sounds can be heard.

Opening the Liquid Crystal Panel and Adjusting the Angle

⚠ WARNING

- To prevent the battery from going dead, operate this unit with the engine running if possible.
- When the liquid crystal panel is operating, be careful not to get your hand or finger caught between the panel and main unit or the instrument panel of the car.
- Do not move the liquid crystal panel by hand.

Standing up the liquid crystal panel

1. Press the [OPEN] button. The liquid crystal panel comes out and stands up automatically.

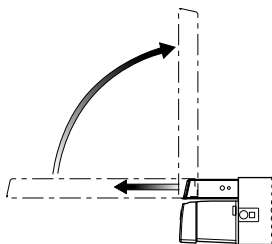

Opening the Liquid Crystal Panel and Adjusting the Angle

Note:

- If the liquid crystal panel stops in the middle of its operation, press the **[OPEN]** button to house the panel and press the button again to raise it. The unit will enter the same display mode as the display was in when last turned off.

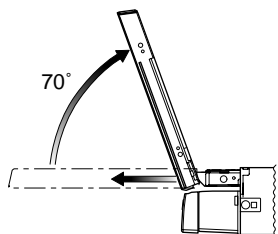

Panel calibration function

The liquid crystal panel's maximum angle of inclination can be adjusted to match the installation configuration within the vehicle.

- Perform this with the panel in its housed position.
- Keep pressing the **[OPEN]** button more than 5 seconds.
The electronic beep will be heard. After the beep sounds twice, the panel will come out and stand up to the maximum angle. After completion of the calibration, the panel will be housed into the unit automatically.
 - If the panel does not strike the instrument panel or other parts of the car during calibration, the maximum inclination will be 110°.
 - If the panel strikes a car part during calibration within a range of 70° inclination, the maximum downward inclination will be 70°.

Adjusting the angle of the liquid crystal panel

The angle of the liquid crystal panel can be adjusted depending on the mounting angle of the unit or light coming into the car.

- Turn the power on. When the liquid crystal panel is closed, press the **[OPEN]** button.
- Press the **[MENU]** button to display the following Menu screen:



- Repeat touching the **[Tilt]** key to adjust the angle of the liquid crystal panel. Every touching the **[Tilt]** key tilts the liquid crystal panel forward or backward. The adjusted angle is stored in memory.
 - Adjustment is possible within the range 70° to 110°.
 - There are 5 adjustable angles available.

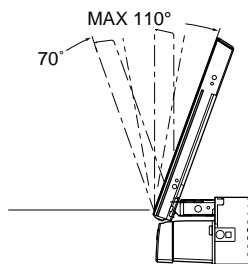

Housing the liquid crystal panel

- Press the **[OPEN]** button.
The liquid crystal panel is housed automatically.

Note:

- When leaving this unit unused for a long period of time or leaving your car, be sure to house the liquid crystal panel.

Turning the liquid crystal panel horizontal (Air conditioner operation mode)

When the way the liquid crystal panel is mounted hinders the operation of the air conditioner, the position of the panel can be turned horizontal temporarily.

- Keep pressing the **[OPEN]** button more than 2 seconds when the liquid crystal panel is open. A beep sounds and the liquid crystal panel turns horizontal.
 - Press the **[OPEN]** button again for the panel to return to the original position.
 - The unit can be set so that the panel returns to the original position after a set time in the horizontal position (see page 62).

Turning the Audio OFF

You can turn off all of the AV features.

1. Keep pressing the [SRC] button more than 1 second.
The AV features are turned off.

Turning the Monitor OFF

You can turn off the monitor screen, and change it to a black screen.

1. Pressing the [MENU] button to display the Menu screen.
2. Touch the [Moni Off] key.
The monitor screen is turned off.

Setting/Ejecting a Disc

Notes on handling discs

Handling

- New discs may have some roughness around the edges. If such discs are used, the player may not work or the sound may skip. Use a ball-point pen or the like to remove any roughness from the edge of the disc.

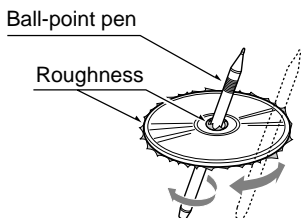

- Never stick labels on the surface of the disc or mark the surface with a pencil or pen.
- Never play a disc with any cellophane tape or other glue on it or with peeling off marks. If you try to play such a disc, you may not be able to get it back out of the DVD player or it may damage the DVD player.
- Do not use discs that have large scratches, are misshapen, cracked, etc. Use of such discs may cause misoperation or damage.
- To remove a disc from its storage case, press down on the center of the case and lift the disc out, holding it carefully by the edges.

Turning the AV features on

1. Press the [SRC] button.
The AV features are turned on, and the system resumes the last status of the AV features.

Turning the monitor on

1. Touch the monitor screen.
The monitor screen is turned on, and resumes the last screen.
 - You can also turn on the monitor by pressing any button except for the [▲] (EJECT), [OPEN], and [VOL -]/[VOL +] buttons.

- Do not use commercially available disc protection sheets or discs equipped with stabilizers, etc. These may damage the disc or cause breakdown of the internal mechanism.

Storage

- Do not expose discs to direct sunlight or any heat source.
- Do not expose discs to excess humidity or dust.
- Do not expose discs to direct heat from heaters.

Cleaning

- To remove fingermarks and dust, use a soft cloth and wipe in a straight line from the center of the disc to the circumference.
- Do not use any solvents, such as commercially available cleaners, anti-static spray, or thinner to clean discs.
- After using special disc cleaner, let the disc dry off well before playing it.

Setting/Ejecting a Disc

On Discs

- Exercise a good precaution when loading a disc with the panel open.
- Never turn off the power and remove the unit from the car with a disc loaded.

⚠ CAUTION

With the liquid crystal panel open, a driver may not be able to see the disc insertion slot. For your safety, insert a disc with the screen closed.

Even when the liquid crystal panel is closed, however, the recessed disc slot may be difficult for a driver to see, care is needed whenever inserting discs.

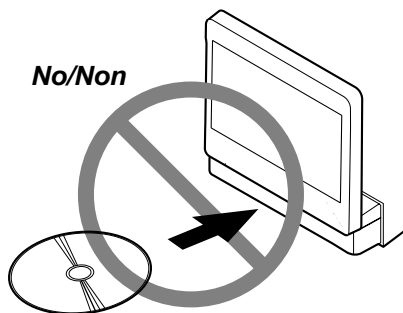

Setting a disc

1. Insert a disc into the center of the insertion slot with the label side facing up. The disc will automatically be drawn into the DVD player.

After setting a disc

The system will automatically be switched to the relevant source media mode according to the disc, and start playing back the disc.

When a DVD video disc is set:

The system is switched to the DVD Video mode. See "DVD Video Operations" (page 29).

When an Audio CD is set:

The system is switched to the CDDA mode. See "Audio CD Operations" (page 35).

When a CD/DVD with MP3/WMA/AAC/DivX files is set:

The system is switched to the MP3/WMA/AAC mode or DivX mode according to the Playform setting. See "MP3/WMA/AAC Operations" (page 37) or "DivX Operations" (page 40).

Note:

- Never insert foreign objects into the disc insertion slot.
- If the disc is not inserted easily, there may be another disc in the mechanism or the unit may require service.
- 8 cm (single play) discs cannot be used.

⚠ CAUTION

For your safety, the driver should not insert or eject a disc while driving.

Ejecting a disc

1. Press the [EJECT] (EJECT) button to eject the disc. The screen changes to the DVD mode screen, and "EJECT" appears.
 - If a disc is left in the ejected position for 15 seconds, the disc is automatically reloaded (Auto reload).
2. Remove the disc carefully.

Note:

- If you force a disc into the insertion slot before auto reloading, this can damage the disc.

Connecting/Disconnecting an USB Media Device

This unit has one USB (Universal Serial Bus) connector which is compatible with USB 1.1 and USB 2.0.

Playable USB media devices

This system can control the following USB media devices connected to the USB connector.

- Apple iPod
- MTP audio player
- USB memory

About the Apple iPod

iPods can be connected by using the connector cable supplied with the iPod, but in this case, you can enjoy it's audio sound only. To enjoy video movies stored in the iPod with video displaying them on this unit, it is required to use the special connector cable separately sold.

Note:

- *This system will not operate or may operate improperly with unsupported versions.*
- *For detailed information on the playable iPod models, see our home page: www.clarion.com*
- *For the other limitations, see "iPod Operations" (page 45).*

About the MTP audio player

MTP (Media Transfer Protocol) is a standard developed by the Microsoft Corporation, and it enables for the Windows Media Player to manage media files stored in general portable media players.

This system has the functions based on the MTP, can control some portable audio players which support the MTP standard, and can play audio files (MP3/WMA) protected with the Windows Media DRM 10 as well as files not protected stored in the players.

Note:

- *This system will not operate or may operate improperly with some MTP audio player.*
- *For detailed information on the playable MTP audio players, see our home page: www.clarion.com*
- *Some files protected with the Windows Media DRM 10 may not be played.*
- *For the other limitations, see "MTP Audio Player Operations" (page 49).*

About the USB memory

This system can play audio files (MP3/WMA/AAC) stored in an USB memory which is recognized as "USB Mass Storage Class device". You can use your USB memory as an audio device by simply copying desired audio files into it.

Note:

- *This system will not operate or may operate improperly with some USB memory.*
- *Files protected with any DRM can not be played.*
- *For the other limitations, see "USB Memory Operations" (page 50).*

Connecting/Disconnecting an USB Media Device

Connecting an USB media device

⚠ CAUTION

- For your safety, the driver should not connect or disconnect an USB media device.
 - Do not start the vehicle's engine while the MTP audio player is connected, since it may result in loss or damage to data on the MTP audio player. Connect the MTP audio player to this unit after starting the engine.
 - Do not remove the DCP while the MTP audio player is connected, since it may result in loss or damage to data on the MTP audio player.
1. Turn on the power of your USB media device, if required.
 2. Confirming the orientation of the connectors, connect the USB media device to the USB connector of this unit.
 - It may take a long time to recognize the connected device.

After connecting an USB device

The system will automatically be switched to the relevant source media mode according to the USB device connected, and start playback.

When an iPod is connected:

The system is switched to the iPod mode. See "iPod Operations" (page 45).

When an MTP audio player is connected:

The system is switched to the MTP Audio Player mode. See "MTP Audio Player Operations" (page 49).

When an USB memory is connected:

The system is switched to the USB Memory mode. See "USB Memory Operations" (page 50).

Note:

- Never insert foreign objects into the USB connector.
- Always insert the USB media device fully into the connector. Incomplete connections may cause the device not to be recognized.

Disconnecting an USB media device

1. Confirm that data transfer is not performed on the USB media device.
For the method to confirm it, see the operation manual of your USB media device.
2. Remove the USB media device from the USB connector.

⚠ CAUTION

Be sure to disconnect the MTP audio player while the vehicle's engine is running. Otherwise, it may result in loss or damage to data on the MTP audio player. Do not stop the engine when the MTP audio player is connected.

Note:

- When turning on the ACC power with no USB media device connected, "**MEDIA CHECK**" may be displayed on the screen if the USB mode is selected.

Selecting a Media Source

When the liquid crystal panel is closed

1. Press the [SRC] button to switch the source mode.
Each time you press the [SRC] button, the source mode changes in the following order:
TUNER mode → (XM mode) → DVD mode → USB mode → Bluetooth mode → AUX mode → TUNER mode...

Note:

- When 2Zone function is ON, the [SRC] button works only for the Main zone. To switch the Sub zone source, specify it from the Source screen, or use the remote control unit.
- The XM mode can be selectable even when no XM tuner is connected to this unit. You can change this XM Source setting so that the XM mode is skipped when no XM tuner is connected (see page 44).

When the liquid crystal panel is open

1. Press the [SRC] button to display the Source screen.



2. Touch the desired Source key you wish to change to.
The system is switched to the corresponding source media mode.

Available media sources

Source mode	Corresponding source media mode	Refer to	Description
TUNER mode	TUNER mode	page 27	—
XM mode* ¹	XM mode	page 42	—
DVD mode	DVD Video mode	page 29	The source media mode differs depending on the data format of the disc set in the DVD player. When no disc is set in the DVD player, "NO DISC" will be displayed.
	CDDA mode	page 35	
	MP3/WMA/AAC mode	page 37	
	DivX mode	page 40	
USB mode	iPod mode	page 45	The source media mode differs depending on the type of the USB media device connected to the USB connector. When no USB media device is connected, "NO MEDIA" will be displayed.
	MTP Audio Player mode	page 49	
	USB Memory mode	page 50	
Bluetooth mode	Bluetooth mode	page 51	—
AUX mode	AUX mode	page 58	—

*1: When the XM Source setting (see page 44) is set to OFF, the [XM] key will not be displayed when no XM tuner is connected to this unit.

Note:

- When the USB mode is selected, video images input from the AUX terminal will be output to the rear monitor. This is normal.

To select the BT Phone or Navigation mode

You can select the BT Phone or Navigation mode from the Menu screen displayed by pressing the [MENU] button.

- For details of the BT Phone mode operations, see "Bluetooth Telephone Operations" (page 53).
- For details of the Navigation mode operations, see "Navigation System Operations" (page 57).

2Zone Function

About the 2Zone function

The 2Zone function is a function that assigns separate source output to the Main zone (this unit) and Sub zone (the optional rear monitor) by simultaneously playing two sources in this system. Therefore, the rear passengers are allowed to enjoy a different video source from the source played on the liquid crystal panel of this unit.

- The source sounds of the Main zone are output from the speakers of the vehicle side, and those of the Sub zone are from the optional headphone systems.
- Controlling a source assigned to the Sub zone can be made by using the optional remote control unit. To control it from this unit, once assign the same source to the Main zone, then control it.
- When a media without video images is played on the Sub zone, a black screen is output to the rear monitor.

Note:

- When an interrupt of the Bluetooth telephone or the navigation system arises during the 2Zone function is turned on, the sound of the Main zone is muted, but the sound of the Sub zone is output normally. When it arises during the 2Zone function is turned off, the audio signals to the 4ch speakers are attenuated, and the voice from the navigation system is output from the front two speakers.
- You cannot operate the 2Zone function during the interrupt of the Bluetooth telephone or the navigation system.
- When the same source is assigned for Main and Sub zones, operations in a zone are also applied for another zone.

Assignable source mode for Main/ Sub zones

●For Main zone

All the source modes can be assigned for the Front zone.

●For Sub zone

The following source modes can be assigned:

- DVD mode
- USB mode
- AUX mode

Setting the 2Zone function

- The factory default setting is OFF.
1. Press the [SRC] button to display the Source screen.
 2. Touch the [2 Zone] tab to display the 2 Zone tab screen.
The source keys for the Sub zone are displayed.



3. Touch the desired source key you wish to assign to the Sub zone.
The 2Zone function is turned on with the selected source mode assigned to the Sub zone.
4. Touch the [Back] key to return to the previous screen.

Note:

- Use the remote control unit to control the source assigned to the Sub zone. To control it from this unit, once select the same source mode as assigned to the Sub zone for the Main zone, and then control it.

Turning off the 2Zone function

1. Press the [SRC] button to display the Source screen.
2. Touch and hold the [2Zone Off] key for more than 1 second.

5. SOURCE OPERATIONS

Radio Operations

Listening to the radio

1. Press the [SRC] button, and touch the [TUNER] key.
The TUNER mode screen is displayed, and the system resumes the last status of the TUNER mode.



2. Touch the [Home] or [Trav] key to select the Home or Travel mode.
The Home/Travel modes are provided to manage the preset stations separately in your home location and in a location during a trip.
3. Touch the [Band] key to select the radio band. Each time the key is touched, the radio reception band changes in the following order:
 - In Home mode: FM Home 1 or 2 → AM Home → FM Home 1 or 2...(The last FM band will be selected.)
 - In Travel mode: FM Travel → AM Travel → FM Travel...
4. Press the [◀◀] or [▶▶] button to tune in the previous or next preset station.

Seek tuning

1. Touch the [Band] key to select the desired band (FM or AM).
2. Touch the [◀◀] or [▶▶] key to automatically seek a station.
 - When touching the [▶▶] key, the station is sought in the direction of higher frequencies.
 - When touching the [◀◀] key, the station is sought in the direction of lower frequencies.

Manual tuning

There are 2 ways available: Quick tuning and step tuning.
When it is in the step tuning mode, the frequency changes one step at a time. In quick tuning mode, you can quickly tune the desired frequency.

1. Touch the [Band] key to select the desired band (FM or AM).
2. Tune into a station.

Quick tuning:

Touch and hold the [◀◀] or [▶▶] key to tune in a station.

Step tuning:

Touch the [◀◀] or [▶▶] key to manually tune in a station.

Recalling a preset station

There are total of 40 preset positions (8-FM Home 1, 8-FM Home 2, 8-AM Home, 8-FM Travel, and 8-AM Travel) to store individual radio stations in memory.

There are 2 ways available to recall the preset station.

● Using the [◀◀] or [▶▶] button

1. Touch the [Home] or [Trav] key and touch the [Band] key to select the desired band (FM or AM).
2. Press the [◀◀] or [▶▶] button to recall the previous or next stored station.

● Using the Preset List screen

1. Touch the [Home] or [Trav] key to select the Home or Travel mode.
2. Touch the [List] key to display the Preset List screen.
3. Touch the desired Band key to select the band.
4. Touch the corresponding Preset key to recall the stored station.
 - Touching and holding the desired Preset key for more than 2 seconds will store the current station to the preset memory.
5. Touch the [Back] key to return to the previous screen.

Manual memory

1. Touch the **[Home]** or **[Trav]** key to select the Home or Travel mode.
2. Touch the **[List]** key to display the Preset List screen.
3. Touch the desired Band key to select the band you wish to store.
4. Tune in the station you wish to store using the seek tuning, manual tuning, or preset tuning.
5. Touch and hold the desired Preset key you wish to store the current station for more than 2 seconds.

Auto Store

The Auto Store is a function for storing up to 8 stations that are automatically tuned in sequentially. If 8 receivable stations cannot be received, a previously stored station remains unoverwritten at the memory position. The Auto Store function works only in the Travel mode.

1. Touch the **[Trav]** key to select the Travel mode.
2. Touch the **[List]** key.
3. Touch desired Band key to select the band (FM or AM).
4. Touch the **[AS]** key to start scanning stations. A beep sounds and the stations with good reception are stored automatically to the preset channels.
 - “AS” appears during scanning stations. To stop the scanning, touch the **[AS]** key again.

ISR (Instant Station Recall) function

Instant station recall is a special radio preset that instantly accesses a favorite radio station at one press of a button. The ISR function even operates with the unit in other modes.

●ISR memory

1. Select the station that you wish to store in ISR memory.
2. Keep pressing the **[ISR]** button more than 2 seconds to store the current station into the ISR memory.

●Recalling a station with ISR

1. In any mode, press the **[ISR]** button to switch to the ISR mode and tune in the stored radio station. “ISR” appears in the display. Press the **[ISR]** button again to return to the previous mode.

Selecting the DVD Video mode

1. Set a DVD video disc to the DVD player.
The system will automatically read the disc data, change to the DVD mode (DVD Video mode), and start playback after a while.
See also "Setting/Ejecting a Disc" (page 21).



⚠ WARNING

- Some videos may be recorded at a higher volume level than desired. Increase the volume gradually from the minimal setting after the video has started.
- For your safety, the driver should not watch the video or operate the controls while driving. Please note that watching and operating the video while driving are prohibited by law in some countries.

Note:

- For your safety, this system has a safety function which turns off the picture when the car is moving, so only the audio can be heard. The picture can only be watched when the car is stopped and the parking brake is applied.
- If "AUDIO ONLY" appears on the screen just after turning on the ACC power of the car, release the parking brake while confirming safety, and then engage the parking brake again.

● When a DVD video disc is already set

1. Press the [SRC] button to display the Source screen.
2. Touch the [DVD] key to select the DVD Video mode.
The system changes to the DVD mode (DVD Video mode), and starts playback from the previous position.

Changing the DVD System Settings

Note:

- If the Setup operation is performed in the middle of DVD video play, the disc will restart from beginning.

Displaying the DVD Setup screen

1. Touch the screen to display the DVD Video mode screen.
2. Touch the [Options] key to display the Options menu.
3. Touch the [Set up] key to display the DVD Setup screen.



- Touch the [✓] key to display the next page.
- Touch the [↶] key to return to the previous page.



4. Perform setting for the desired setting items. See the following sections for detail.
 - In the following sections, only the details of settings are described, the procedures to select items are skipped.
5. Touch the [Back] key.

DVD Video Operations

Setting up the screen size

Set up the screen size according to the optional rear monitor which is connected to this unit.

- The factory default setting is "Wide".
- 4-1. Touch the [Wide], [PS], or [LB] key of the TV Display item to change the screen size to "Wide", "Pan Scan" or "Letter Box".

- When watching through a wide type of the rear monitor (16:9)

Wide:

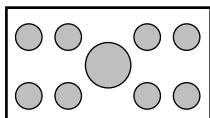

- When watching through a conventional type of the rear monitor (4:3)

Pan Scan:

The leftmost and rightmost areas of the screen are cut off.

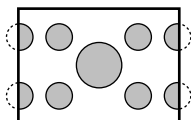

This function allows displaying the important part of image fully on the screen. In some cases, image is displayed while being panned (scrolled).

Letter Box:

A black zone is created in the top and bottom areas of the screen.

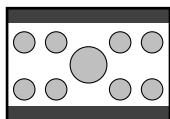

This method displays Cinema Scope and Vista Vision images without cutting them off by creating a black zone on the top and bottom gaps.

Setting up the angle mark display

You can set up so that the angle mark appears on scenes where the angles can be switched.

- The factory default setting is "OFF".
- 4-1. Touch the [ON] or [OFF] key of the Angle item to turn the Angle function ON or OFF.

Setting up the disc menu language

- The factory default setting is "English".
- 4-1. Touch the [>>] key of the Menu Language item.
 - 4-2. Touch the desired Language key you wish to set.
 - 4-3. Touch the [Back] key.

Setting up the audio language

- The factory default setting is "English".
- 4-1. Touch the [>>] key of the Audio Language item.
 - 4-2. Touch the desired Language key you wish to set.
 - 4-3. Touch the [Back] key.

Setting up the subtitle language

- The factory default setting is "English".
- 4-1. Touch the [>>] key of the Subtitle Language item.
 - 4-2. Touch the desired Language key you wish to set.
 - To turn off the subtitle, select the [Off] key.
 - 4-3. Touch the [Back] key.

Setting up the password for setting up of the parental level

- The factory default setting is "0000".
- 4-1. Touch the [>>] key of the Password item.
 - 4-2. Touch the ten-key (0 to 9) to input a 4-digit password.
 - Input the old password, and touch the [ENT] key.
 - Input "4356" to reset password to "0000".
 - Input a new password, and touch the [ENT] key.
 - Input the same new password again, and touch the [ENT] key.

Note:

- When a disc with view restrictions is inserted, you will be prompted to input a password. The disc will not be viewable until the correct password is entered.

Setting up the country code

Set up the country number for setting up of the parental level.

- The factory default setting is "8583" (U.S.A.).

- 4-1. Touch the [▶▶] key of the Country Code item.
- 4-2. Touch the ten-key (0 to 9) to input a 4-digit country code (see the following table).
- 4-3. Touch the [ENT] key.

Country code list:

Country	Input code
Canada	6765
United States	8583
American Samoa	6583
Bermuda	6677
Puerto Rico	8082
St. Pierre and Miquelon	8077
Virgin Islands (U.S.)	8673

Setting up the parental level

You can change the level of parental lock (audiovisual restriction).

This function allows cutting scenes that are unfavorable for children or replacing them automatically with other scenes prepared in advance. For example, by replacing scenes of radical violence or portrayals of sex with safe scenes, you can make a trouble-free story as if it were so from the beginning.

- The factory default setting is "8".
- 4-1. Touch the [◀] or [▶] key of the Parental Level item.
The Password input screen is displayed.
 - 4-2. Touch the ten-key (0 to 9) to input a 4-digit password, and touch the [ENT] key.
 - The factory default setting of the password is "0000".
 - 4-3. Touch the [◀] or [▶] key to select level "1" to "8", or "No Parental".
The relationship between DVD video category codes and parental level are shown in the table below. Use this table when setting the parental level.

LEVEL7	NC-17 (NO ONE 17 AND UNDER ADMITTED)
LEVEL6	R (RESTRICTED)
LEVEL4	PG-13 (PARENTS STRONGLY CAUTIONED)
LEVEL3	PG (PARENTAL GUIDANCE SUGGESTED)
LEVEL1	G (GENERAL AUDIENCES)

- The contents that the parental level restricts vary with the country code.

Operating a DVD video

Watching a DVD Video

After disc loading, the play mode is automatically engaged.

- When playback is not started, touch the [▶/||] key.
- Operations may differ depending on the story of the disc.

● About the volume adjustment when playing DVD Video discs

This system has the independent volume data for playing DVD Video discs. The volume setting during DVD playback does not affect the volume of the other modes, and the volume setting in the other modes does not affect the DVD playback.

● When the DVD menu is displayed

For general DVD Video discs, the DVD menu may appear.

After the DVD menu is displayed, select an item in the operations described as follows.

DVD Video Operations

Showing the DVD Video mode screen

The DVD Video mode screen is used to control the playback mode from the screen.

1. Touch the screen.
The DVD Video mode screen is displayed.
If you do not touch the screen for 7 seconds, the display will return to the playback screen.

Selecting the screen size

You can change the screen size to suit to the playback film.

- The factory default setting is "F.Wide".
1. Touch the screen to display the DVD Video mode screen.
 2. Repeat touching the [**Wide/F.Wide/Cinema/Normal**] key until your desired screen size is selected.
 - This key shows the current screen size setting.

[Wide]:

The image is expanded in the same way as the [**F.Wide**] setting, but the width will become narrower. Depending on the image data, black areas may be displayed at the both sides of the screen.

[F.Wide]:

The image is expanded so that the rectangle of the image fits to the screen (16:9). The aspect ratio of the image may be changed.

[Cinema]:

The image is expanded so that the top and bottom edges of the image fit to the screen. Suitable for letterbox-format images. Subtitles of non-letterboxed images may be cut off in this mode.

[Normal]:

The image is expanded so that the top and bottom edges of the image fit to the screen, and that the aspect ratio of the image becomes 4:3. The aspect ratio of the image may be changed.

3. Touch the [**Hide**] key to return to the playback screen.

DVD menu operations

● Showing the DVD menu

1. Showing the DVD Video mode screen, touch the [**Menu**] or [**Top Menu**] key during playback.
The DVD menu appears.
 - The displayed contents for each key differ depending on the DVD software.

- An example shown below is the DVD menu display:



● Operating the DVD menu

You can operate the menu items by displaying the Key Pad panel.

1. Keep pressing the [**MENU**] button more than 1 second.
The Cursor-Key Pad panel is displayed on the screen.
 - Touching the [**Num**] key changes the panel to the Numeric-Key Pad.
2. Select the desired menu item using either the Cursor-Key or the Numeric-Key according to the menu contents.
3. Touch the [**ENT**] key to specify the selected menu item.
4. Touch the [**Hide**] key to hide the Key Pad panel.

● Switching Key Pad position

When the menu items become difficult to view by the Key Pad buttons, you can move the Key Pad panel to the other side of the screen.

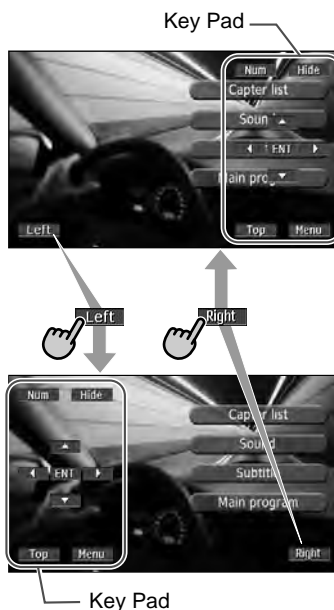

Stopping playback

1. Showing the DVD Video mode screen, touch and hold the [▶/■] key for more than 1 second during playback. Playback is stopped.
2. To resume playback, touch the [▶/■] key. Playback resumes from the scene where playback is stopped.

Pausing playback

1. Showing the DVD Video mode screen, touch the [▶/■] key during playback. Playback pauses.
2. To resume playback, touch the [▶/■] key again. Playback resumes.

Slow playback

1. Showing the DVD Video mode screen, touch the [▶/■] key during playback to pause playback.
2. Touch and hold the [▶▶] key. While touching the key, slow playback continues at 1/3 speed. Releasing the key resumes the normal playback.
 - Slow playback cannot be performed in the backward direction. In addition, audio cannot be reproduced during slow playback.
 - You can also use the [▶▶] button instead of the [▶▶] key.

Fast forward and fast backward

1. Keep pressing the [◀◀] or [▶▶] button during playback.
 - [▶▶] button: Fast forward
 - [◀◀] button: Fast backward

The playback speed becomes 4-times faster at first and then 16-times faster 3 seconds later. Releasing the button resumes the normal speed playback.

 - No audio is reproduced during fast forward and fast backward operation.
 - The fast forward and fast backward speed may differ depending on the disc.
 - You can also use the [◀◀] and [▶▶] keys instead of the [◀◀] and [▶▶] buttons.

Skipping chapters (searching)

“Chapter” means a small segment to divide the “Title” (film) which is recorded on the disc.

1. Press the [◀◀] or [▶▶] button during playback. Chapters are skipped as many as the times pressing the button, and playback starts.

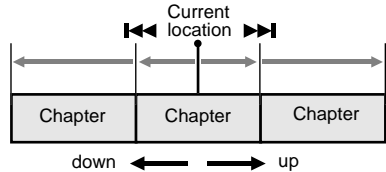

- Pressing the [▶▶] button starts playback from the beginning of the next chapter.
- Pressing the [◀◀] button starts playback from the beginning of the current chapter. When pressing this button again within about 4 seconds, playback starts from the beginning of the previous chapter.
- You can also use the [◀◀] and [▶▶] keys instead of the [◀◀] and [▶▶] buttons.

Searching with a chapter/title number

You can locate the beginning of a scene using the chapter numbers or title numbers recorded on the DVD video disc.

- “Chapter” means a small segment to divide the “Title” (film) which is recorded on the disc.
1. Showing the DVD Video mode screen, touch the [Options] key.
 2. Touch the [Direct] key. The Key Pad screen appears.
 - You can select the next title by touching the [Title] key.
 3. Input the chapter number that you want to play back using the [0] to [9] key.
 4. Touch the [ENT] key. Playback starts from the scene of the input chapter number of the selected title.
 - If the input chapter number does not exist or searching with a chapter number is not allowed, the screen image will not change.

Repeat playback

This operation plays back the current title or chapter repeatedly.

1. Showing the DVD Video mode screen, touch the **[Options]** key.
2. Touch the **[Title]** or **[Chapter]** key of the Repeat item, then touch the **[Back]** key. The "T.RPT" or "C.RPT" will be displayed.
3. Perform the same operation to turn off the repeat playback.

Switching among languages

On discs in which two or more audios or audio languages have been recorded, you can switch among the audio languages during playback.

1. Showing the DVD Video mode screen, touch the **[Options]** key.
2. Touch the **[Audio]** key during playback. Each time you touch the key, you can switch among audio languages.
 - Depending on the disc, up to 8 audios may be recorded. For details, see the mark of the disc (Ⓢ): Indicates that 8 audios have been recorded).
 - Depending on the disc, switching may be completely impossible or impossible on some scenes.
 - It may take time to switch among audios.
 - When the power is turned on and the disc is changed to a new one, the language set as the factory default is selected. If that language has not been recorded, the language is specified on the disc.
3. Touch the **[Back]** key to return to the previous screen.

Switching subtitles

On DVD discs in which two or more subtitle languages have been recorded, you can switch among the subtitle languages during playback.

1. Showing the DVD Video mode screen, touch the **[Options]** key.
2. Touch the **[Subtitle]** key during playback. The Subtitle Language screen appears.
3. Touch the Language key you wish to display.
 - Depending on the disc, up to 32 kinds of subtitles may be recorded. For details, see the mark of the disc (Ⓢ): Indicates that 8 kinds of subtitles have been recorded).
 - To turn of subtitles, select "OFF".
 - Depending on the disc, switching may be completely impossible or impossible on some scenes.
 - It may take time to switch among subtitles.

4. Touch the **[Back]** key to return to the previous screen.

Switching angles

On DVD discs in which video images have been recorded in two or more angles, you can switch among the angles during playback.

- This operation can be performed when the "Setting up the angle mark display" function (see page 30) is set to "ON".
1. Showing the DVD Video mode screen, touch the **[Angle]** key during playback. Each time you touch the key, you can switch among angles.
 - Depending on the disc, up to 9 angles may be recorded. For details, see the mark of the disc (Ⓜ): Indicates multi-angle).
 - Depending on the disc, angles may switch smoothly or switch with a momentary still image.
 - Depending on the disc, switching may be completely impossible or impossible on some scenes.
 - It may take time to switch among angles.
 - Depending on the disc, scenes recorded in two or more angles may be played back.
 - When the power is turned on and the disc is changed to a new one, the language set at the time of factory shipment is selected. If that language has not been recorded, the language is specified on the disc.

Displaying/hiding the playback status

1. Showing the DVD Video mode screen, touch the **[Options]** key.
2. Touch the **[ON]** or **[OFF]** key of the P.Time item during playback.
3. Touch the **[Back]** key to return to the previous screen. Playback status is displayed on the screen.

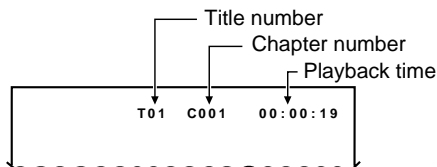

Audio CD Operations

This system is a CD TEXT compatible model, and supports the display of the DISC TITLE, TRACK TITLE, and TRACK ARTIST of the CD TEXT.

Note:

- This unit supports only CD TEXT in English. Also, some character data may not be reproduced properly on the display.

Selecting the CDDA mode

1. Set an audio CD to the DVD player.
The system will automatically read the disc data, change to the DVD mode (CDDA mode), and start playback after a while.
See also "Setting/Ejecting a Disc" (page 21).



⚠ WARNING

- Some CDs may be recorded at a higher volume level than desired. Increase the volume gradually from the minimal setting after playback has started.
- For your safety, the driver should not operate the controls while driving.

● When an audio CD is already set

1. Press the [SRC] button to display the Source screen.
2. Touch the [DVD] key to select the CDDA mode.
The system changes to the DVD mode (CDDA mode), and starts playback from the previous position.

Operating an audio CD

Listening to an audio CD

After disc loading, the play mode is automatically engaged.

- When playback is not started, touch the [▶/⏸] key.

Pausing playback

1. Touch the [▶/⏸] key during playback.
Playback pauses.
2. To resume playback, touch the [▶/⏸] key.
Playback resumes.

Skipping a track (searching)

1. Press the [⏮] or [⏭] button during playback.
Tracks are skipped, as many as the times the button is pressed, and playback starts.
 - Pressing the [⏭] button starts playback from the beginning of the next track.
 - Pressing the [⏮] button starts playback from the beginning of the current track.
When this button is pressed again within about 2 seconds, playback starts from the beginning of the previous track.
 - You can also use the [⏮] and [⏭] keys instead of the [⏮] and [⏭] buttons.

Fast forward and fast backward

1. Press and hold the [⏮] or [⏭] button during playback.
The playback speed becomes 4-time faster first and then 16-time faster 3 seconds later. Releasing the button resumes the normal speed playback.
 - You can also use the [⏮] and [⏭] keys instead of the [⏮] and [⏭] buttons.

Other various play functions

1. Touch the **[Options]** key.
2. Touch the **[Track]** key of the function you want to play.
Track repeat playback:
Touch the **[Track]** key of the Repeat item.
 - This operation plays back the current track repeatedly.
 - "T.RPT" is displayed on the screen.**Track random playback:**
Touch the **[Track]** key of the Random item.
 - This operation plays back all tracks on the disc in no particular order.
 - "T.RDM" is displayed on the screen.
3. To cancel the play, touch the **[Track]** key of the function to cancel.
4. Touch the **[Back]** key to return to the previous screen.

Scrolling track titles

When a title or name displayed on the screen is longer than the text area, you can confirm the entire text by scrolling it.

1. Displaying the text you wish to scroll, touch the **[>>]** key displayed at the right of the text area.
The text will scroll once.

This system can playback MP3/WMA/AAC files recorded on a disc.

About the MP3/WMA/AAC files

What is MP3/WMA/AAC?

MP3, WMA, and AAC are the audio file formats which have penetrated into PC users and become a standard format.

MP3 is an audio compression method and classified into audio layer 3 of MPEG standards. WMA (Windows Media Audio) is an audio compression method developed by Microsoft Corporation.

AAC (Advanced Audio Coding) is a newer audio compression method developed for used with video compression standards MPEG-2 and MPEG-4, and has been adopted as the standard audio format of the iPod and iTunes by Apple Inc. These features compress the original audio data to about 10 percent of its initial size with a high sound quality. This means that about 10 audio CDs can be recorded on a CD-R/RW disc to allow a long listening time without having to change CDs.

Displaying MP3/WMA/AAC Tag titles

Tag information (track title, artist name, and album title) can be displayed for an MP3/WMA/AAC file containing the Tag information.

This system supports the ID3 TAG version 1.x/2.x and WMA-TAG.

Note:

- Tag information entered with 2-byte characters may not be displayed properly on the display.
- The ID3 version 2.x tag format is not completely supported. This system can display information up to 60 bytes, and ignores the rest.
- Album titles of WMA-TAG may not be displayed properly.

Precautions on the MP3/WMA/AAC files

● General precautions

- Files other than MP3/WMA/AAC format cannot be played. In addition, some files may not be played because of the encoding settings. When a file cannot be played, the next file is played instead.
- Some noise may occur depending on the type of encoder software used to encode the data.
- You can apply the VBR (Variable Bit Rate) format when encoding. In this case, the displayed play time may be slightly different from the actual play time.
- Files that the DRM (Digital Rights Management) function is set cannot be played.

● For MP3 files

- Set the Sampling Frequency to:
 - MPEG1 Layer3: 32, 44.1, or 48 kHz
 - MPEG2 Layer3: 16, 22.05, or 24 kHz
 - MPEG2.5 Layer3: 8, 11.025, or 12 kHz
- Set the Bit Rate to:
 - MPEG1 Layer3: 32 to 320 kbps (VBR)
 - MPEG2 Layer3: 8 to 160 kbps (VBR)
 - MPEG2.5 Layer3: 8 to 160 kbps (VBR)
- Add a file extension “.MP3” or “.mp3” using single byte characters.

● For WMA files

- Set the Sampling Frequency to within ranges from 22.05 to 44.1 kHz.
- Set the Bit Rate to 48, 64, 80, 96, 128, 160, or 192 kbps.
- Add a file extension “.WMA” or “.wma” using single byte characters.

● For AAC files

- This system supports only the MPEG4 Audio files encoded by the iTunes.
- Set the Sampling Frequency to 44.1 or 48 kHz.
- Set the Bit Rate to within ranges from 16 to 320 kbps (VBR).
- Add a file extension “.M4A” or “.m4a” using single byte characters.

MP3/WMA/AAC Operations

Precautions when preparing a disc

Note:

- For details of the DivX file mentioned below, see "DivX Operations" (page 40).

● Logical format (File system)

The following writing formats are available when writing MP3/WMA/AAC/DivX files on a disc:

- For CD-R/RW: ISO9660 level 1/level 2, Romeo, Joliet, or Apple ISO (without including expansion format)
- For DVD±R/RW: UDF (Universal Disk Format)

● Folder structure

- The folder hierarchy must be within 8 hierarchical levels. Otherwise, playback will be impossible.
- You can store the MP3 files, WMA files, and AAC files together in a disc or folder.
- You can also store the MP3/WMA/AAC files and DivX files together in a disc or folder. In such a case, you can select whether the disc is regarded as an MP3/WMA/AAC disc or as a DivX disc. see "Setting the Playform of discs recorded with DivX files" (page 39).

● Number of files or folders

- The maximum allowable number of folders is 255 (including root directory).
- The maximum allowable number of files in a disc is 999.
- The maximum allowable number of files in a folder is 255.

● Folder representation in the folder list

- Only folders containing MP3/WMA/AAC files or DivX files (① to ④ in illustration) are displayed on the list. Folders containing no MP3/WMA/AAC/DivX file are not displayed.
- Folder hierarchy (① to ④ in illustration) is ignored, and unified into one level.
- Folders are arranged in the order of the folder creation.

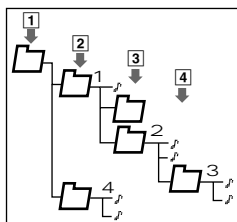

Selecting the MP3/WMA/AAC mode

- Set a disc which the MP3/WMA/AAC files are recorded to the DVD player. The system will automatically read the disc data, change to the DVD mode (MP3/WMA/AAC mode), and start playback after a while. See also "Setting/Ejecting a Disc" (page 21).



⚠ WARNING

- Audio files may be recorded at a higher volume level than desired. Increase the volume gradually from the minimal setting after playback has started.
- For your safety, the driver should not operate the controls while driving.

Note:

- Note that the system enters to the DivX mode when setting a disc with DivX files if the Playform function has been set to "Video" (see page 39).

● When a disc is already set

- Press the [SRC] button to display the Source screen.
- Touch the [DVD] key to select the MP3/WMA/AAC mode. The system changes to the DVD mode (MP3/WMA/AAC mode), and starts playback from the previous position.

Operating MP3/WMA/AAC playback

Note:

- The same operations listed below are also used in the MTP Audio Player and USB Memory modes.

Listening to MP3/WMA/AAC files

After disc loading, the play mode is automatically engaged.

- When playback is not started, touch the [▶/||] key.

Pausing playback

1. Touch the **[▶/||]** key during playback.
Playback pauses.
2. To resume playback, touch the **[▶/||]** key.
Playback resumes.

Skipping a track (searching)

1. Press the **[◀◀]** or **[▶▶]** button during playback.
Tracks are skipped, as many as the times the button is pressed, and playback starts.
 - Pressing the **[▶▶]** button starts playback from the beginning of the next track.
 - Pressing the **[◀◀]** button starts playback from the beginning of the current track.
When this button is pressed again within about 2 seconds, playback starts from the beginning of the previous track.
 - You can also use the **[◀◀]** and **[▶▶]** keys instead of the **[◀◀]** and **[▶▶]** buttons.
 - These functions perform in the current folder only.

Fast forward and fast backward

1. Press and hold the **[◀◀]** or **[▶▶]** button during playback.
The playback speed becomes 4-time faster first and then 16-time faster 3 seconds later.
Releasing the button resumes the normal speed playback.
 - You can also use the **[◀◀]** and **[▶▶]** keys instead of the **[◀◀]** and **[▶▶]** buttons.

Skipping the current folder

1. Touch a **FOLDER** key during playback.
The tracks of the current folder are skipped and playback starts from the first track of the next or previous folder.

Selecting a folder/track from the list screen

1. Touch the **[List]** key.
The Folder List screen is displayed.
2. When the desired folder is not displayed, touch the **[▲]** or **[▼]** key to scroll the list.
3. Touch the desired Folder key.
The Track List screen appears.
4. Touch the **[▲]** or **[▼]** key to scroll the list, and touch the desired Track key.
The corresponding track is started playback.
5. Touch the **[Back]** key.

Other various play functions

1. Touch the **[Options]** key.
2. Touch a touch key of the function you want to play.
 - Folder repeat playback:**
Touch the **[Folder]** key of the Repeat item.
 - This operation plays back tracks in the current folder repeatedly.
 - "F.RPT" is displayed on the screen.
 - Track repeat playback:**
Touch the **[Track]** key of the Repeat item.
 - This operation plays back the current track repeatedly.
 - "T.RPT" is displayed on the screen.
 - Folder random playback:**
Touch the **[Folder]** key of the Random item.
 - This operation plays the tracks in the current folder in a random order.
 - "F.RDM" is displayed on the screen.
 - Track random playback:**
Touch the **[Track]** key of the Random item.
 - This operation plays back tracks recorded in the disc in no particular order.
 - "T.RDM" is displayed on the screen.
3. To cancel the play, touch the same touch key of the function to cancel.
4. Touch the **[Back]** key to return to the previous screen.

Scrolling track titles

When a title or name displayed on the screen is longer than the text area, you can confirm the entire text by scrolling it.

1. Displaying the text you wish to scroll, touch the **[>>]** key displayed at the right of the text area.
The text will scroll once.

Setting the Playform of discs recorded with DivX files

MP3/WMA/AAC files can be stored together with DivX files in a disc or folder. You can select whether such discs are regarded as MP3/WMA/AAC discs or as DivX discs.

1. Touch the **[Options]** key.
2. Touch the **[Audio]** or **[Video]** key of the Playform item to specify the setting.
 - [Audio]:**
Discs are regarded as MP3/WMA/AAC discs.
 - [Video]:**
Discs are regarded as DivX discs.
3. Touch the **[Back]** key.

Note:

- This setting is disabled when a Mixed Mode CD, which contains both data track and audio tracks, is set in the DVD player.

DivX Operations

This system can playback DivX movie files recorded on a disc.

- Official DivX[®] Certified product
- Plays all versions of DivX[®] video (including DivX[®] 6) with standard playback of DivX[®] media files.

About the DivX file

What is DivX?

DivX is a popular media technology created by DivX, Inc. DivX media files contain highly compressed video with high visual quality that maintains a relatively small file size. DivX files can also include advanced media features like menus, subtitles, and alternate audio tracks. Many DivX media files are available for download online, and you can create your own using your personal content and easy-to-use tools from DivX.com.

Precautions on the DivX file

- This system can play DivX version 4.x, 5.x, and 6.x files. DivX Ultra is not supported.
- Files other than DivX format cannot be played. In addition, some files may not be played because of the encoding format. When a file cannot be played, the next file is played instead.
- DivX VOD (Video-on Demand files) that have authorization data can also be played. These files must be authorized on your PC beforehand using the DivX Registration Code displayed on the System tab screen under the General Settings screen (see page 63).
- Set the Frame Size to 640 x 480 or 320 x 240 pixels.
- Set the Frame Rate to 30 or 15 fps.
- Add a file extension “.AVI”, “.avi”, “.DIVX”, or “.divx” using single byte characters.

Precautions when preparing a disc

Note:

- The limitations on preparing a disc are same as those in the MP3/WMA/AAC modes. See “Precautions when preparing a disc” (page 38).

Selecting the DivX mode

1. Set a disc which the DivX files are recorded to the DVD player.
The system will automatically read the disc data, change to the DVD mode (DivX mode), and start playback after a while.
See also “Setting/Ejecting a Disc” (page 21).



⚠ WARNING

- **Some movie files may be recorded at a higher volume level than desired. Increase the volume gradually from the minimal setting after the movie has started.**
- **For your safety, the driver should not watch the movie or operate the controls while driving. Please note that watching and operating the movie while driving are prohibited by law in some countries.**

Note:

- For your safety, this system has a safety function which turns off the picture when the car is moving, so only the audio can be heard. The picture can only be watched when the car is stopped and the parking brake is applied.
- If “AUDIO ONLY” appears on the screen just after turning on the ACC power of the car, release the parking brake while confirming safety, and then engage the parking brake again.
- You can store DivX files and the MP3/WMA/AAC files together in a disc or folder. In such a case, you can select whether the disc is regarded as a DivX disc or as an MP3/WMA/AAC disc. See “Setting the Playform of discs recorded with audio files” (page 41).

● When a disc is already set

1. Press the [SRC] button to display the Source screen.
2. Touch the [DVD] key to select the DivX mode. The system changes to the DVD mode (DivX mode), and starts playback from the previous position.

Operating DivX playback

Note:

- The most operations in the DivX mode are same as those in the MP3/WMA/AAC modes. See also "Operating MP3/WMA/AAC playback" (page 38).
- The random plays cannot be specified in the DivX mode.

Watching DivX movies

After disc loading, the play mode is automatically engaged.

- When playback is not started, touch the [▶/■] key.

● To play a file with Authorization data

When a file with Authorization data is played, a message is displayed on the screen. Confirm the message displayed, and touch the [Done] or [Yes] key to play the movie.

Showing the DivX mode screen

The DivX mode screen is used to control the playback mode from the screen.

1. Touch the screen.
 - The DivX mode screen is displayed. If you do not touch the screen for 7 seconds, the display will return to the playback screen.
 - You can hide the DivX mode screen by touching the [Hide] key.

Selecting the screen size

You can change the screen size to suit to the playback film.

- The factory default setting is "F.Wide".
1. Touch the screen to display the DivX mode screen.
 2. Repeat touching the [Wide/F.Wide/Cinema/Normal] key until your desired screen size is selected.
 - This key shows the current screen size setting.

[Wide]:

The image is expanded in the same way as the [F.Wide] setting, but the width will become narrower. Depending on the image data, black areas may be displayed at the both sides of the screen.

[F.Wide]:

The image is expanded so that the rectangle of the image fits to the screen (16:9). The aspect ratio of the image may be changed.

[Cinema]:

The image is expanded so that the top and bottom edges of the image fit to the screen. Suitable for letterbox-format images. Subtitles of non-letterboxed images may be cut off in this mode.

[Normal]:

The image is expanded so that the top and bottom edges of the image fit to the screen, and that the aspect ratio of the image becomes 4:3. The aspect ratio of the image may be changed.

3. Touch the [Hide] key to return to the playback screen.

Searching with a folder/track number

You can specify a file to play using the folder number or track number.

1. Showing the DivX screen, touch the [Options] key.
2. Touch the [Direct] key.
 - The Key Pad screen appears with the folder number input mode.
3. Input the folder/track number that you want to play back using the [0] to [9] key.
 - Touching the [Track] key turns the Key Pad to the track number input mode.
4. Touch the [ENT] key.
 - The system starts playback of the file specified with the input folder/track numbers.
 - If the input folder/track number does not exist or searching with a folder/track number is not allowed, the screen image will not change.

Setting the Playform of discs recorded with audio files

DivX files can be stored together with MP3/WMA/AAC files in a disc or folder. You can select whether such discs are regarded as DivX discs or as MP3/WMA/AAC discs.

1. Showing the DivX screen, touch the [Options] key.
2. Touch the [Audio] or [Video] key of the Playform item to specify the setting.
 - [Audio]:**
Discs are regarded as MP3/WMA/AAC discs.
 - [Video]:**
Discs are regarded as DivX discs.
3. Touch the [Back] key.

Note:

- This setting is disabled when a Mixed Mode CD, which contains both data track and audio tracks, is set in the DVD player.

6. SOURCE OPERATIONS (ACCESSORIES)

XM Satellite Radio Operations

This function is available when an XM tuner is connected.

This unit can control the following satellite radio receiver:

- XM Mini-Tuner

Note:

- Be sure to turn off the ACC power before connecting/disconnecting the XM tuner.

Selecting the XM mode

1. Press the [SRC] button, and touch the [XM] key.
The system changes to the XM mode.



Note:

- If the [XM] key is not displayed or the message "CHECK XM TUNER" is displayed, check the connection with the XM Satellite Radio Receiver.
- The audio output is muted and other button operations are not accepted during channel selection.

● Information displayed during reception

The following information is displayed when the satellite radio cannot be received normally.

- When a channel is being tuned in (no signal is yet received): "LOADING"
- A channel without a broadcast has been selected: "CH UNAVAILABLE"
- A channel not covered by your contract: "CH UNAUTHORIZED"
- When a channel is out of air time: "OFF AIR"
- When no signal is received: "NO SIGNAL"
- When the XM antenna is not connected correctly: "CHECK ANTENNA"

Selecting a band

1. Touch the [Band] key to select a band.
This changes the reception band as follows:
XM1 → XM2 → XM3 → XM1 ...

Confirming your Radio ID

1. Touch the [Options] key to display the Options screen.
2. Touch the [Direct] key to display the Key Pad screen.
3. Touch the [0] key, then touch the [ENT] key.
Receiving the Channel "0" will display your Radio ID (8-digits number).

Switching the operation mode

Usually, the system will operate in the Channel selection mode. You can switch this to the Category selection mode by the following operation.

1. Touch the [CAT] key to switch to the Category selection mode.
If you do not perform operation for 15 seconds, the system will automatically return to the Channel selection mode.
 - Touch the [Back] key to switch to the Channel selection mode within 15 seconds.

Tuning in a station

Only channels that can be received are selected. Channels without broadcasts and channels not covered by the contract will be skipped.

- This operation works only in the Channel selection mode.
1. Touch the [◀◀] or [▶▶] key.
The system displays the information on the previous or next available channel.
 2. Touch the [(●)] (Enter) key within 5 seconds.
The system will tune to the channel that the information is displayed.

Note:

- If you do not touch the [(●)] (Enter) key within 5 seconds, the system will return to the previous display.
- When the Direct function is set to "ON" from the Options screen, touching the [(●)] (Enter) key is not required. The system will automatically receive the specified channel when 2 seconds passes.

Selecting a station with the channel number

- This operation works only in the Channel selection mode.
1. Touch the [Options] key to display the Options screen.
 2. Touch the [Direct] key to display the Key Pad screen.
 3. Enter the channel number of your desired station by touching the [0] to [9] keys.
 - If you enter a wrong number, you can cancel it by touching the [CLR] key.
 4. Touch the [ENT] key.
The radio channel you entered will be tuned.

Recalling a preset station

A total of 24 XM stations can be stored (8-XM1, 8-XM2, and 8-XM3). This allows you to store your favorite XM stations in memory for later recall. There are 2 ways available to recall a preset station.

- This operation works only in the Channel selection mode.

● Using the [◀◀] or [▶▶] button

1. Touch the [Band] key to select the desired band (XM1, XM2, or XM3).
2. Press the [◀◀] or [▶▶] button to recall the previous or next stored station.

● Using the Preset List screen

1. Touch the [List] key to display the Preset List screen.
2. Touch the desired Band key to select the band.
3. Touch the corresponding Preset key to recall the stored station.
The system will tune to the specified station.
 - Touching and holding the desired Preset key for more than 2 seconds stores the current station into preset memory.
4. Touch the [Back] key to return to the previous screen.

Manual memory

1. Touch the [List] key to display the Preset List screen.
2. Touch the desired Band key to select the band.
3. Tune to the station you wish to store.
4. Touch and hold the desired Preset key you wish to store to for more than 2 seconds to store the current station into the preset memory.
5. Touch the [Back] key to return to the previous screen.

XM Satellite Radio Operations

Receiving stations selected by category

Satellite Radio allows you to select broadcast channel category (contents).

1. Touch the **[CAT]** key to display the Category List screen.
2. Touch the desired Category item key to select the category.
 - Touch the **[▲]** or **[▼]** key to scroll the category list.
3. Touch the **[◀▶]** or **[▶▶]** key to select a station.

The system displays the information on the previous or next available channel that meets the specified category.
4. Touch the **[(●)]** (Enter) key within 5 seconds.

The system will tune to the channel that the information is displayed.

Note:

- When the Category List screen is displayed, the category of the last received channel is displayed first.
- If you do not touch the **[(●)]** (Enter) key within 5 seconds, the system will return to the previous display.
- When the Direct function is set to "ON" from the Options screen, touching the **[(●)]** (Enter) key is not required. The system will automatically receive the specified channel when 2 seconds passes.
- When no operation is made within 15 seconds, the system will return to the Channel selection mode.

Category Scan function

In a category scan, broadcast channels in the same category as the current channel are selected about every 10 seconds. During scanning channels are displayed in abbreviated form, the display mode cannot be switched.

1. Touch the **[CAT]** key to display the Category List screen.
2. Touch the desired Category item key to select the category.
 - Touch the **[▲]** or **[▼]** key to scroll the category list.
3. Touch the **[CAT SCAN]** key.

The system will start the category scan.
4. Touch the **[CAT SCAN]** key again to tune to the channel currently selected.

The category scan will be terminated.

Note:

- Category scanning is not available when no category is defined for the current channel.

Changing the Direct setting

When this function is set to "ON", touching the **[(●)]** (Enter) key is not required to tune in the station selected.

- The factory default setting is "OFF".
1. Touch the **[Options]** key to display the Options screen.
 2. Touch the **[ON]** or **[OFF]** key of the Direct item to set this function to "ON" or "OFF".
 3. Touch the **[Back]** key.

Setting XM Source function

When this function is set to "OFF", the **[XM]** key is not displayed on the Source screen when no XM tuner is connected.

- The factory default setting is "ON".
1. Touch the **[Options]** key to display the Options screen.
 2. Touch the **[ON]** or **[OFF]** key of the XM Source item to set this function to "ON" or "OFF".
 3. Touch the **[Back]** key.

iPod Operations

iPods can be connected by using the connector cable supplied with the iPod, but in this case, you can enjoy its audio sound only. To enjoy video movies stored in the iPod with video displaying them on this unit, it is required to use the special connector cable (CCA-723) separately sold.

Note:

- This system will not operate or may operate improperly with unsupported versions.
- For detailed information on the playable iPod models, see our home page: www.clarion.com

Notes on using Apple iPod

- Do not connect an iPod to this unit with a headphone connected to the iPod.
- After the iPod has been connected to this unit, the iPod's buttons are disabled for operation in the Music mode. In the Video mode, do not operate the iPod's buttons.
- When in the iPod mode, a special iPod control screen is displayed different from the main screens for other modes.
- When in the iPod mode, the screen image input from the AUX terminal is output to the rear monitor.
- When no data is present, the title display will remain blank.
- The iPod is used with the equalizer function turned OFF.
- Set the iPod's language setting to English before connecting your iPod. Some characters of the other languages may not be displayed correctly in this system.

●Precautions on battery consumption:

If the iPod is connected to this unit when the iPod's internal battery has run down, this function may not operate correctly. You must connect the iPod after charging the battery if it has run down.

Selecting the iPod mode

1. Connect your iPod to the USB connector. The system will automatically detect the connected device, and change to the USB mode (iPod mode), and start playback after a while. See also "Connecting/Disconnecting an USB Media Device" (page 23).
- When an iPod is already connected
 1. Press the [SRC] button to display the Source screen.
 2. Touch the [USB] key to select the iPod mode. The system changes to the USB mode (iPod mode), and starts playback from the previous position.

Controlling the iPod

Operation keys

●iPod mode screen

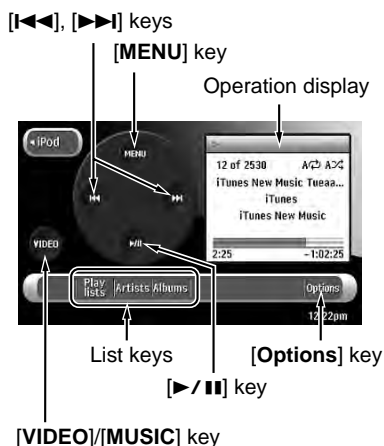

[VIDEO] / [MUSIC] key:
Switches the operation mode to the Video mode or Music mode.

- Displayed only when an iPod with video features is connected.

[MENU] key:
Displays the iPod Menu screen to search tracks to be played. Various list screens can be displayed from the iPod Menu screen.

[▶/||] key:
Use to control playback and pause.

[<<], [>>] keys:
Use to perform track selection. Touch and hold to enable fast-forward or fast-backward.

iPod Operations

List keys:

Displays the corresponding list screen.

[**Playlists**], [**Artists**], and [**Albums**] are available in the Music mode.

[Hide] key:

Hides the iPod mode screen to display the playback picture.

- Displayed only in the Video mode.

[Options] key:

Displays the Options screen. You can specify repeat and shuffle play modes from this screen.

● Operation display

Play (▶)/Pause (⏸) status display

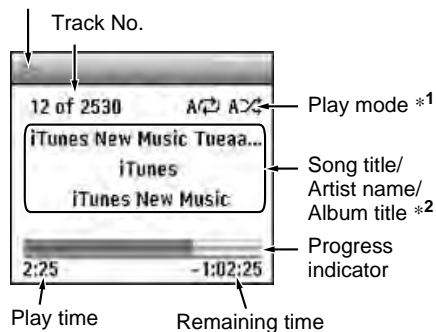

Note:

*1 Displays status of Repeat, Shuffle play.

↻ : 1-track Repeat

A↻ : All Repeat

S↻ : Song Shuffle

A↻ : Album Shuffle

*2 Touch the operation display to scroll the Song title.

Pausing playback

1. Touch the [▶/⏸] key during playback. Playback pauses.
2. To resume playback, touch the [▶/⏸] key again. Playback resumes.

Skipping a track (searching)

1. Press the [◀◀] or [▶▶] button during playback. Tracks are skipped, as many as the times the button is pressed, and playback starts.
 - Pressing the [▶▶] button starts playback from the beginning of the next track.
 - Pressing the [◀◀] button starts playback from the beginning of the current track. When this button is pressed again within about 2 seconds, playback starts from the beginning of the previous track.
 - You can also use the [◀◀] and [▶▶] keys instead of the [◀◀] and [▶▶] buttons.

Fast forward and fast backward

1. Press and hold the [◀◀] or [▶▶] button during playback. The playback speed becomes faster. Releasing the button resumes the normal speed playback.
 - You can also use the [◀◀] and [▶▶] keys instead of the [◀◀] and [▶▶] buttons.

Other various play functions

1. Touch the [Options] key.
2. Touch a touch key of the function you want to play.

1-track repeat:

Touch the [One] key of the Repeat item.

- This operation plays back the current or selected track repeatedly.

All repeat:

Touch the [All] key of the Repeat item.

- This operation plays back all the tracks currently selected repeatedly.

Song shuffle:

Touch the [Song] key of the Shuffle item.

- This operation plays back all the tracks currently selected in a random order.

Album shuffle:

Touch the [Album] key of the Shuffle item.

- When more than one album is selected, this operation plays back the albums in no particular order. Tracks in an album are played back in the recorded order.

3. To cancel the shuffle play, touch the [OFF] key of the function to cancel.
 - The repeat play cannot be canceled. Normally, it should be set to the All repeat play.
4. Touch the [Back] key to return to the previous screen.

iPod Menu Operation

You can specify the tracks to play by narrowing the following categories:

● In the Music mode

[Albums]:

The list of all the Albums stored in the iPod is displayed.

[Artists]:

You can narrow the Albums to be listed by specifying the Artist name.

[Genres]:

You can narrow the Artists to be listed by specifying the Genre name.

[Songs]:

The list of all the Tracks stored in the iPod is displayed.

[Playlists]:

The list of all the Playlists stored in the iPod is displayed.

[Composers]:

You can narrow the Albums to be listed by specifying the Composer name.

● In the Video mode

- Displayed items may be changed depending on the firmware version of the iPod.

[Playlists]:

The list of all the Video Playlists stored in the iPod is displayed.

[Movies]:

The list of all the Movies stored in the iPod is displayed.

[Music Videos]:

You can narrow the Albums to be listed by specifying the Artist name.

[TV Shows]:

You can narrow the Seasons to be listed by specifying the Program title.

[Video Podcasts]:

You can narrow the Tracks to be listed by specifying the Video Podcast name.

Displaying the iPod Menu screen

1. Touch the [MENU] key from the iPod mode screen.

The iPod Menu screen of the current operation mode is displayed.



Selecting tracks to be played from a list screen

1. Touch the desired Category key from the iPod Menu screen to display the corresponding list screen.
2. Touch the desired item key on the screen to specify it.
 - Touch the [▲] or [▼] key to scroll the list.
 - When a track list of an Album, Playlist, or Video Playlist is displayed, specifying a track starts playback of the specified album/playlist from the specified track.
 - When the track list of the Songs is displayed, specifying a track starts playback of all the tracks stored in the iPod from the specified track.
 - When the playback starts, the display will return to the iPod mode screen.
 - When the other list screen is displayed, repeat this operation until you select the tracks to be played back.
 - When video tracks are specified in the Music mode, only the audio data will be played back.

Viewing video data in the iPod (only for the iPod with video)

When you connect an iPod with video by using the optional connector cable, you can enjoy the video data stored in the iPod showing them on the liquid crystal panel of this unit (and the rear monitor if connected).

WARNING

- **Some videos may be recorded at a higher volume level than desired. Increase the volume gradually from the minimal setting after the video has started.**
- **For your safety, the driver should not watch the video or operate the controls while driving. Please note that watching and operating the video while driving are prohibited by law in some countries.**

1. Touch the **[Video]** key on the iPod mode screen to switch to the Video mode.
2. Play back your desired video tracks.
The specified video image will be displayed on the rear monitor if connected.
3. Touch the **[Hide]** key to hide the iPod mode screen.
The video image will be displayed on this unit.
4. To display the iPod mode screen, touch the screen.
 - When you touch the **[Music]** key during playing back video data, audio playback will continue until you select the music tracks to be played in the Music mode.

Note:

- **"AUDIO ONLY"** is displayed when the automobile is moving.
- Do not operate the original control of the iPod in the Video mode.
- Video data may not be played back according to the status of the iPod.
- The volume setting of video data is relatively lower than audio data. Be sure to lower the volume setting before switching to the other mode.
- Do not select the categories with no track registered from the iPod Menu screen. The iPod may be frozen.

MTP Audio Player Operations

This system has the functions based on the MTP (Media Transfer Protocol) developed by the Microsoft Corporation, can control some portable audio players which support the MTP standard, and can play audio files (MP3/WMA) stored in the players.

Note:

- This system will not operate or may operate improperly with some MTP audio player.
- For detailed information on the playable MTP audio players, see our home page: www.clarion.com

Notes on using MTP audio players

● General notes

- After the MTP audio player has been connected to this unit, the player's buttons are disabled for operation.
- When no data is present, the message "NO FILE" will be displayed.
- The MTP audio player is used with the equalizer function turned OFF.

● Notes on the MP3/WMA files

- This system can play the MP3/WMA files stored in the MTP audio player.
- For the MTP Audio Player mode, this system can play a file protected with the Windows Media DRM 10 if the player has the license key for that file.
- Some files protected with the Windows Media DRM 10 may not be played.
- This system cannot play movie files stored in the MTP audio player.
- For the other limitations on these files, see "Precautions on the MP3/WMA/AAC files" (page 37).

● Notes on the folder structure

- This system can manage up to 512 folders (including root directory and folders with no MP3/WMA file).
- The maximum allowable number of files in a folder is 255.
- You can store the MP3 files and WMA files together in a folder.

● Notes on the Tag titles

The limitations on the Tag titles are same as those in the MP3/WMA modes. See "Displaying MP3/WMA/AAC Tag titles" (page 37).

● Folder representation in the folder list

The limitations on the folder representation are same as those in the MP3/WMA modes. See "Folder representation in the folder list" (page 38).

Selecting the MTP Audio Player mode

1. Connect your MTP audio player to the USB connector.
The system will automatically detect the connected device, and change to the USB mode (MTP Audio Player mode), and start playback after a while.
See also "Connecting/Disconnecting an USB Media Device" (page 23).



● When an MTP audio player is already connected

1. Press the [SRC] button to display the Source screen.
2. Touch the [USB] key to select the MTP Audio Player mode.
The system changes to the USB mode (MTP Audio Player mode), and starts playback from the previous position.

Controlling the MTP audio player

The most operations in the MTP Audio Player mode are same as those in the MP3/WMA modes. See "Operating MP3/WMA/AAC playback" (page 38) for details.

Notes:

- The playback speed of the fast forward and fast backward functions differs depending on the MTP audio player.
- The fast forward and fast backward function will not work upon the files protected with the Windows Media DRM 10.
- When you change the source mode to the other or turn off the power during playing back a track, and then select the MTP Audio Player mode again, the track will be played back from the beginning. Though, the track protected with the Windows Media DRM 10 will not be played back automatically.

USB Memory Operations

This system can play audio files (MP3/WMA/AAC) stored in an USB memory which is recognized as "USB Mass Storage Class device". You can use your USB memory as an audio device by simply copying desired audio files into it.

Note:

- This system will not operate or may operate improperly with some USB memory.
- Files protected with any DRM can not be played.

Notes on using USB memories

● General notes

- When no data is present, the message "NO FILE" will be displayed.
- The USB memory is used with the equalizer function turned OFF.

● Notes on the MP3/WMA/AAC files

- This system can play the MP3/WMA/AAC files stored in the USB memory.
- This system cannot play DivX files stored in the USB memory.
- For AAC files, this system supports only the MPEG4 Audio files encoded by the iTunes.
- Set the Sampling Frequency to:
 - For MP3 files:
 - MPEG1 Layer3: 32, 44.1, or 48 kHz
 - MPEG2 Layer3: 16, 22.05, or 24 kHz
 - MPEG2.5 Layer3: 8, 11.025, or 12 kHz
 - For WMA files: 32, 44.1, or 48 kHz
 - For AAC files: 44.1 or 48 kHz

- Set the Bit Rate to:

For MP3 files:

- MPEG1 Layer3: 32 to 320 kbps (VBR)
- MPEG2 Layer3: 16 to 160 kbps (VBR)
- MPEG2.5 Layer3: 16 to 160 kbps (VBR)

For WMA files: 32, 48, 64, 80, 96, 128, 160, or 192 kbps

For AAC files: 16 to 320 kbps (VBR)

- Add the following file extension using single byte characters:

For MP3 files: ".MP3" or ".mp3"

For WMA files: ".WMA" or ".wma"

For AAC files: ".M4A" or ".m4a"

● Notes on the folder structure

- The folder hierarchy must be within 8 hierarchical levels. Otherwise, playback will be impossible.
- The maximum allowable number of folders is 512 (including root directory and folders with no MP3/WMA/AAC file).
- The maximum allowable number of files in a folder is 255.
- You can store the MP3 files, WMA files, and AAC files together in a folder.

● Notes on the Tag titles

The limitations on the Tag titles are same as those in the MP3/WMA/AAC modes. See "Displaying MP3/WMA/AAC Tag titles" (page 37).

● Folder representation in the folder list

The limitations on the folder representation are same as those in the MP3/WMA/AAC modes. See "Folder representation in the folder list" (page 38).

Selecting the USB Memory mode

1. Connect your USB memory to the USB connector.
The system will automatically detect the connected device, and change to the USB mode (USB Memory mode), and start playback after a while.
See also "Connecting/Disconnecting an USB Media Device" (page 23).



● When an USB memory is already connected

1. Press the [SRC] button to display the Source screen.
2. Touch the [USB] key to select the USB Memory mode.
The system changes to the USB mode (USB Memory mode), and starts playback from the previous position.

Playing back files in the USB memory

The operations in the USB Memory mode are same as those in the MP3/WMA/AAC modes. See "Operating MP3/WMA/AAC playback" (page 38) for details.

Note:

- When performing the fast forward or fast backward function, the playback speed will become 10-time faster. For the VBR files, it may differ depending on the file.

Bluetooth Audio Player Operations

Some Bluetooth cellular phones have the audio features, and some portable audio player support the Bluetooth feature. These devices will be called as "Bluetooth audio players" in this manual. This system can play audio data stored in a Bluetooth audio player.

Note:

- The Bluetooth audio players are managed separately from the Bluetooth telephones. However, if the same device has been registered in the BT Phone mode, the audio player can connect to this unit even when it is not registered in the Bluetooth mode. If you wish to connect from this unit, register the audio player again in the Bluetooth mode.
- This system will not operate or may operate improperly with some Bluetooth audio players.
- For detailed information on the playable Bluetooth audio players, see our home page: www.clarion.com

Selecting the Bluetooth mode

1. Press the [SRC] button to display the Source screen.
2. Touch the [Bluetooth] key to select the Bluetooth mode.

The system changes to the Bluetooth mode. If the connection with a Bluetooth audio player has been already established, the system will start playback after a while.

- When the connection with a Bluetooth audio player has been established, the name of the connected audio player is displayed at the top of the screen, and the  icon is displayed at the bottom of the screen.



Bluetooth audio player settings

Confirming Bluetooth Information and setting Pass Key

You can confirm the various information concerning the Bluetooth Interface features.

1. Touch the [BT Info] key to display the information on the screen.



2. When you finish confirming the Bluetooth information, touch the [Back] key to return to the previous screen.
If you want to change the Pass Key setting of this unit, perform the following steps.
 - The factory default setting is "1234".
3. Touch the text box of the Pass Key item to display the Ten-Key Pad screen.
4. Enter your desired 4-digit PIN number, then touch the [ENT] key.

Registering your Bluetooth audio player (Pairing)

You can register up to 5 Bluetooth audio players.

1. Turn on the power of the Bluetooth audio player you wish to register.
2. Touch the [Device] key to display the Device Select screen.



3. Touch the [Add] key to display the Add the Device screen.
4. Touch your desired Device key to select the key for the Bluetooth audio player to be registered.
 - You cannot select the Device key of which another Bluetooth audio player is already registered. Select a blank Device key.
5. Touch the [Search] or [Wait] key.

[Search]:

The system starts searching a Bluetooth audio player.

[Wait]:

The system waits to be detected by a Bluetooth audio player.

Bluetooth Audio Player Operations

- When you specify "**Search**", perform the acknowledgement operation for the Bluetooth connection on your Bluetooth audio player, if it is prompted.

When you specify "**Wait**", perform the search operation of Bluetooth devices on your Bluetooth audio player.

- If entering the Pass Key code is prompted on your Bluetooth audio player, enter the Pass Key code set to this unit.

- You can change the Pass key setting of this unit from the BT Info screen.

When the pairing operation completes, the registered Bluetooth audio player is set as the current device, and the display returns to the Bluetooth mode screen.

Note:

- You cannot register the same Bluetooth audio player which is already registered doubly. If you wish to change the Device key registered, once delete the corresponding Bluetooth audio player from the previous Device key, and then register it again to your desired Device key.

● To delete the Bluetooth audio player registration

- Touch the **[Device]** key.
- Touch the **[Delete]** key to display the Delete the Device screen.
- Touch the desired Device key you wish to delete.
A confirmation screen is displayed.
- Touch the **[Yes]** key to perform deletion.

Selecting the Bluetooth audio player

To change the current Bluetooth audio player to the other device which is already registered, perform the following operation.

- Touch the **[Device]** key to display the Device Select screen.
- Touch the desired Device key you wish to use.
The corresponding Bluetooth audio player is set as the current device.
 - If the power of the Bluetooth audio player is not turned on, turn it on.
 - The Bluetooth audio player may prompt to acknowledge the Bluetooth connection or to enter the Pass Key code of this unit.
Perform these operations according to the message displayed.
- Touch the **[Back]** key to return to the previous screen.

Controlling the Bluetooth audio player

Note:

- Occasionally, depending on the environment, playback sounds may be fragmented, or switch noises may be generated.

Playing back a music

After the connection with a Bluetooth audio player is established, the play mode is automatically engaged.

- When playback is not started, touch the **[▶/■]** key.

Pausing playback

- Touch the **[▶/■]** key during playback.
Playback pauses.
- To resume playback, touch the **[▶/■]** key.
Playback resumes.

Skipping a track (searching)

- Press the **[◀◀]** or **[▶▶]** button during playback.
Tracks are skipped, as many as the times the button is pressed, and playback starts.
 - You can also use the **[◀◀]** and **[▶▶]** keys instead of the **[◀◀]** and **[▶▶]** buttons.

Fast forward and fast backward

- Press and hold the **[◀◀]** or **[▶▶]** button during playback.
The system enters the fast backward or fast forward playback mode during pressing the button.
Releasing the button resumes the normal speed playback.
 - You can also use the **[◀◀]** and **[▶▶]** keys instead of the **[◀◀]** and **[▶▶]** buttons.

Bluetooth Telephone Operations

When the connection with your Bluetooth cellular phone is established, the following functions are available on this unit:

- Listening to your telephone calls on the car speakers.
- Answering to an incoming call.
- Making a call using the Ten-Key pad screen.
- Making a call using the Phone Book data in the selected cellular phone.
- Making a call using the History data of the dialed/received calls.
- Redialing

Note:

- The Bluetooth cellular phones are managed separately from the Bluetooth audio players. However, when you wish to use the same device as the audio player, register it in the BT Phone mode ahead. If the same device has been already registered in the Bluetooth mode, it may connect to this unit even when it has not been registered in the BT Phone mode. In such case, the Phone Book, History, and 10Key functions are disabled.
- Some cellular phones may not be able to transfer the Phone Book data.
- The Phone Book data transmission may take a long time. The operations of sending calls are disabled during the data transmission.
- You can talk with other party by using the internal microphone. When it is hard to hear for the other party in accordance with the communication condition or the used telephone, use the optional microphone (RCB-199), and set the Microphone Select setting to "**External**" (page 54). The sound will be improved, but noises may still be heard depending on the communication condition.

Selecting the BT Phone mode

1. Press the [MENU] button to display the Menu screen.
2. Touch the [BT Phone] key to select the BT Phone mode.

The Telephone screen is displayed.

- When the connection with a Bluetooth telephone has been established, the  icon, battery indicator, and signal level indicator are displayed at the bottom of the screen.



2. Perform setting for the desired item. See the following sections for detail.
3. Touch the [Back] key to return to the previous screen.

● Setting Automatic Connection

The system automatically reconnects the cellular phone after the connection is lost or the system is restarted.

- The factory default setting is "**OFF**".

- 2-1. Touch the [ON] or [OFF] key of the Automatic Connection item to set the function ON or OFF.

● Setting Automatic Incoming Call

When a call comes in, the system automatically connects the call approx. 5 seconds after the calling starts.

- The factory default setting is "**OFF**".

- 2-1. Touch the [ON] or [OFF] key of the Automatic Incoming Call item to set the function ON or OFF.

Telephone settings

Setting the telephone features

1. Touch the [Setting] key to display the Telephone Settings screen.



Bluetooth Telephone Operations

● Setting Noise Canceller

You can reduce noise generated during hands-free talk. This function may reduce the sound quality.

- Select either LOW or HIGH depending on the type of your vehicle and cellular phone.
- The factory default setting is "LOW".

- 2-1. Touch the [LOW] or [HIGH] key of the Noise Canceller item to set the function.

[LOW]:

Suitable for a GSM cellular phone.

[HIGH]:

Suitable for a CDMA cellular phone.

● Setting Ring Tone Select

The system can ring if the cellular phone cannot generate ring tones when the Bluetooth connection has been established.

- The factory default setting is "AUTO".

- 2-1. Touch the [AUTO] or [Internal] key of the Ring Tone Select item to set the function.

[AUTO]:

The system will ring only when the cellular phone cannot generate ring tones.

[Internal]:

The system will ring regardless of the cellular phone. Select this when no ring tone is generated with the "AUTO" selected.

● Setting Ring Tone Volume

You can adjust the volume of the ring tone in 10 levels.

- The factory default setting is "5".

- 2-1. Touch the [◀] or [▶] key of the Ring Tone Volume item to adjust the volume level.

● Setting Registration Type

You can change the distribution of maximum number of Phone Book data can be registered to each telephone.

- The factory default setting is "3".

- 2-1. Touch the [✔] key to display the next screen.

- 2-2. Touch the [1], [2], or [3] key of the Registration Type item to set the function.

[1]:

Allows 250 records for first two cellular phones, and no record for the others.

[2]:

Allows 200 records for first cellular phone, 100 records for second and third cellular phones, and 50 records for the others.

[3]:

Allows 100 records for each cellular phone.

● Selecting Microphone

You can select the microphone to be used.

- The factory default setting is "Internal".

- 2-1. Touch the [✔] key to display the next screen.

- 2-2. Touch the [External] or [Internal] key of the Microphone Select item to set the function.

Note:

- When the "Internal" is selected, and a call comes in during the liquid crystal panel closed, you cannot talk to the other party because the microphone is on the liquid crystal panel. To talk to the other party, open the liquid crystal panel.
- When the "Internal" is selected, the [OPEN] button and the [Tilt] key are disabled during a call.

● Setting Microphone Gain

You can adjust the input level of the microphone in 5 levels.

- The factory default setting is "3".

Note:

- The input level of the microphone can be affected by its surroundings. Adjust the level when the person on the other end of the telephone has a reception problem.

- 2-1. Touch the [✔] key to display the next screen.

- 2-2. Touch the [◀] or [▶] key of the Microphone Gain item to adjust the input level.

● Confirming Bluetooth Information and setting Pass Key

You can confirm the various information concerning the Bluetooth Interface features.

- 2-1. Touch the [✔] key to display the next screen.

- 2-2. Touch the [Info] key of the BT Info item to display the information on the screen.

- 2-3. When you finish confirming the Bluetooth information, touch the [Back] key to return to the previous screen.

If you want to change the Pass Key setting of this unit, perform the following steps.

- 2-4. Touch the text box of the Pass Key item to display the Ten-Key Pad screen.

- The factory default setting is "1234".

- 2-5. Enter your desired 4-digit PIN number, then touch the [ENT] key.

Registering your cellular phone (Pairing)

You can register up to 5 cellular phones.

1. Turn on the power of the cellular phone you wish to register.

2. Touch the **[Cellular]** key to display the Cellular Select screen.

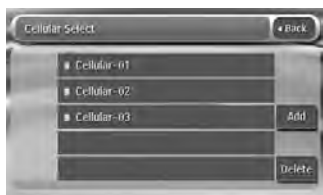

3. Touch the **[Add]** key to display the Add the Cellular screen.
4. Touch your desired Cellular key to select the key for the cellular phone to be registered.
 - You cannot select the Cellular key of which another cellular phone is already registered. Select a blank Cellular key.
5. Touch the **[Search]** or **[Wait]** key.

[Search]:

The system starts searching a cellular phone.

[Wait]:

The system waits to be detected by a cellular phone.

6. When you specify “**Search**”, perform the acknowledgement operation for the Bluetooth connection on your cellular phone, if it is prompted.
When you specify “**Wait**”, perform the search operation of Bluetooth devices on your cellular phone.
7. If entering the Pass Key code is prompted on your cellular phone, enter the Pass Key code set to this unit.

- You can change the Pass key setting of this unit by the BT Info screen under the Telephone Settings screen.

When the pairing operation completes, the registered cellular phone is set as the current telephone, and the display returns to the Telephone screen.

Note:

- You cannot register the same cellular phone which is already registered doubly. If you wish to change the Cellular key registered, once delete the corresponding cellular phone from the current Cellular key, and then register it again to your desired Cellular key.

● To delete the cellular phone registration

1. Touch the **[Cellular]** key.
2. Touch the **[Delete]** key to display the Delete the Cellular screen.
3. Touch the desired Cellular key you wish to delete.
A confirmation screen is displayed.
4. Touch the **[Yes]** key to perform deletion.

Selecting the cellular phone

To change the current cellular phone to the other device which is already registered, perform the following operation.

1. Touch the **[Cellular]** key to display the Cellular Select screen.
2. Touch the desired Telephone key you wish to use.
The corresponding cellular phone is set as the current telephone.
 - If the power of the cellular phone is not turned on, turn it on.
 - The cellular phone may prompt to acknowledge the Bluetooth connection or to enter the Pass Key code of this unit. Perform these operations according to the message displayed.
3. Touch the **[Back]** key to return to the previous screen.

Obtaining the Phone Book data

Sending the Phone Book data from the cellular phone enables you to make a call using the Phone Book function from this unit.

1. Perform the Object Push transfer operation of the Phone Book data on the current cellular phone.
For details of the operation, see the operation manual of the cellular phone.

Note:

- Some cellular phones may not be able to transfer the Phone Book data.
- Some cellular phones cannot transfer the Phone Book data when the hands-free mode is set or it is also registered in the Bluetooth mode. In those cases, disable these functions from the cellular phone before performing the Object Push transfer.

Telephone operations

Note:

- For your safety, this system disables the calling functions when the car is moving. Be sure to stop the car and apply the parking brake before making a call.

Making a call using the Ten-Key pad

1. Touch the **[10Key]** key to display the Ten-Key pad screen.
2. Enter the telephone number by using the Ten-Key pad displayed on the screen.

Bluetooth Telephone Operations

3. Touch the [] (Send) key to call the entered number.

- The following Telephone Interrupt screen is displayed during phone call.



- Touch the [**Private**] key to talk using the cellular phone canceling the hands-free function. To return to the hands-free mode, touch the [**Hands Free**] key.
 - Touch the [**Mic**] key to turn off the microphone so that the sound does not be heard by the partner.
4. When the call is finished, touch the [**End**] key to hang up.
The display will return to the previous mode screen selected before entering the BT Phone mode.

Note:

- Depending on the cellular phone, the Telephone Interrupt screen may be closed and the connection with this system may be disconnected when entering the Private mode.

Redialing

1. Touch the [**Redial**] key to call the last dialed number.
The Telephone Interrupt screen is displayed, and calling starts.
 - When the call is finished, touch the [**End**] key to hang up.

Note:

- When the dialed telephone number cannot be transferred from the cellular phone, "Unknown" is displayed instead of the number.

Making a call using the Phone Book

You can use the Phone Book data obtained from the cellular phone to make a call from this unit.

Note:

- Before using this function, the Phone Book data must be sent from the cellular phone (see page 55).
 - Only the Phone Book items with at least one telephone number registered in the captured Phone Book data are displayed on the Phone Book screen.
1. Touch the [**PhoneBook**] key to display the Phone Book screen.

2. Touch the desired Name key you wish to dial.
 - Touch the [**▲**] or [**▼**] key to scroll the list.
 - When you touch the alphabet key at the right of the screen, the list scrolls to the item which starts with the specified character.
3. Touch the desired Number key you wish to dial.
The confirming message will appear.
4. Touch the [**Yes**] key to call the specified number.
The Telephone Interrupt screen is displayed, and calling starts.
 - When the call is finished, touch the [**End**] key to hang up.

Making a call using the History

The system will memorize the Dialed/Received calls record data in the memory. You can confirm it and use it to make a call from this unit.

1. Touch the [**History**] key.
The History List screen is displayed.
 - The items are sorted in the order of the number of times of Dialed/Received calls.
 - Touch the [**▲**] or [**▼**] key to scroll the list.
 - Touch the [**Back**] key to return to the previous screen.
2. Touch the desired History item key you wish to dial.
The confirming message will appear.
3. Touch the [**Yes**] key to call the specified number.
The Telephone Interrupt screen is displayed, and calling starts.
 - When the call is finished, touch the [**End**] key to hang up.

Answering to an incoming call

When a call comes in, the following Telephone Interrupt screen appears.



You can answer to the incoming call on this system by the following operation.

1. Press the [] (SEND/END) button or touch the [**Send**] key to answer to the call.
 - When the call is finished, touch the [**End**] key to hang up.

Notes on the NAVI functions

- Hereafter in this section, the Navigation system will be called as “**NAVI**”.
- When the Clarion NAVI NAX980HD/ NAX970HD is connected, the following functions are available:
 - Showing the NAVI display
 - Operation by using the touchkeys on screen
 - NAVI guidance voice interruption
- When a voice interrupt of the NAVI arises during 2Zone ON, the sound of the Main zone is muted, and the sound of the Sub zone is output normally. When it arises during 2Zone OFF, the audio signals to the 4ch speakers are attenuated, and the voice from the navigation system is output from the front two speakers.

NAVI operations

Changes between the NAVI display and the Audio/Visual (hereinafter, referred as “**AV**”) display.

Note:

- *The below-mentioned operations are available only when the Clarion NAVI (NAX980HD/ NAX970HD) is connected.*

● When in the AV mode

- Press the [**MAP**] button to switch to the NAVI mode. You can also select it by touching the [**Navigation**] key from the Menu screen.
- When the image interruption from the NAVI arises, the screen will be changed to the NAVI display. When the interruption is finished, the screen will return to the previous AV display.

● When in the NAVI mode

- Touch the [**AV**] key on the screen to switch to the AV mode.
- AV operations made in the NAVI mode will be indicated for about 2 seconds at the bottom of the NAVI screen.

● Button operations

[MAP] button

- When in the AV mode, pressing this button switches to the NAVI mode.
- When in the NAVI mode, the Map screen of the NAVI will be displayed.

[MENU] button

- When in the NAVI mode, displays the Top menu of this unit.

AUX Operations

This function is available when a VTR, etc. is connected to the AUX terminal.

⚠ WARNING

- For your safety, the driver should not watch the video or operate the controls while driving. Please note that watching and operating the video while driving are prohibited by law in some countries.

Note:

- For your safety, this system has a safety function which turns off the picture when the car is moving, so only the audio can be heard. The picture can only be watched when the car is stopped and the parking brake is applied.
- When an iPod with video is connected using the special connector cable (CCA-723) separately sold, the video/audio input from the iPod will be output to the monitor screen and rear monitor even in the AUX mode. However, you must select the iPod mode to control the iPod.

Selecting the AUX mode

1. Press the [SRC] button, and touch the [AUX] key.

Showing the AUX mode screen

The AUX mode screen is used to adjust settings concerning the AUX mode.

1. Touch the screen.
The AUX mode screen is displayed.
If you do not touch the screen for 7 seconds, the display will return to the video screen.

Changing the audio input level

The input audio level of the AUX terminals can be changed.

- The factory default setting is "HIGH".
1. Touch the screen to display the AUX mode screen, then repeat touching the [SENS] key to select the level.
HIGH: 10 dB
MID: 4 dB
LOW: 0 dB

Selecting the screen size

You can change the screen size to suit to the video image.

- The factory default setting is "F.Wide".
1. Touch the screen to display the AUX mode screen.
 2. Repeat touching the [F.Wide/Cinema/Normal/Wide] key until your desired screen size is selected.
 - This key shows the current screen size setting.

[F.Wide]:

The image is expanded so that the rectangle of the image fits to the screen (16:9). The aspect ratio of the image may be changed.

[Cinema]:

The image is expanded so that the top and bottom edges of the image fit to the screen.

[Normal]:

The image is expanded so that the top and bottom edges of the image fit to the screen, and that the aspect ratio of the image becomes 4:3. The aspect ratio of the image may be changed.

[Wide]:

The image is expanded in the same way as the [F.Wide] setting, but the width will become narrower. Depending on the image data, black areas may be displayed at the both sides of the screen.

3. Touch the [Hide] key to return to the video screen.

Audio Settings

Displaying the Audio Settings screen

You can customize the various audio settings of this unit from the Audio Settings screen.

1. Press the **[MENU]** button.
The Menu screen appears.
2. Touch the **[Audio]** key.
The Audio Settings screen appears.



3. Touch the desired Tab key, and perform the adjustment.
See the following sections for details.
 - In the following sections, only the details regarding adjustments are described, procedures to select items are skipped.
4. When the adjustment completes, touch the **[Back]** key to return to the previous screen.

Setting the DZE (Digital Z-Enhancer)

This system provides 3 types of sound tone effects stored in memory. You can select desired setting.

- The factory default setting is "OFF".
- 3-1. Touch the **[DZE]** key to display the DZE tab screen.
 - 3-2. Touch the **[OFF]**, **[DZE 1]**, **[DZE 2]**, or **[DZE 3]** key you wish to set.
 - [OFF]:**
No sound effect.
 - [DZE 1]:**
Suitable for the genuine speakers.
 - [DZE 2]:**
Suitable for separate speakers commercially sold.
 - [DZE 3]:**
Suitable for the coaxial speakers commercially sold.
 - 3-3. When you select an item other than "OFF" in step 2, adjust the effect level by touching the **[◀]** or **[▶]** key.
Setting range: -3 to 3
 - The factory default setting is "0".

Notes:

- The volume changes each time the DZE setting is switched.
- Sufficient effects cannot be obtained with some speaker systems. In such cases, adjust the volume.
- When you set the DZE to other than "OFF", the TONE and M-B EX (Magna Bass Extend) settings are disabled.

Audio Settings

Adjusting the Tone

You can adjust the sound tone by performing the following adjustments.

Note:

- These operations are disabled when the DZE (Digital Z-Enhancer) function is set to other than "OFF".

Adjusting the BASS

The bass gain, bass frequency (center frequency) and bass Q can be adjusted as follows.

- 3-1. Touch the **[TONE]** key to display the TONE tab screen.
- 3-2. Touch the **[BASS]** key.
- 3-3. Touch the **[◀]** or **[▶]** key for the desirable type to adjust to a desirable level.
 - GAIN:** -6 to 8
 - The factory default setting is "0".
 - FREQ:** 50Hz, 80Hz, 120Hz
 - The factory default setting is "50Hz".
 - Q:** 1, 1.25, 1.5, 2
 - The factory default setting is "1".

Adjusting the MID

The middle gain, middle frequency (center frequency) and middle Q can be adjusted as follows.

- 3-1. Touch the **[TONE]** key to display the TONE tab screen.
- 3-2. Touch the **[MID]** key.
- 3-3. Touch the **[◀]** or **[▶]** key for the desirable type to adjust to a desirable level.
 - GAIN:** -6 to 6
 - The factory default setting is "0".
 - FREQ:** 700Hz, 1kHz, 2kHz
 - The factory default setting is "1kHz".
 - Q:** 1.5, 2
 - The factory default setting is "2".

Adjusting the TREBLE

The treble gain and treble frequency (center frequency) can be adjusted as follows.

- 3-1. Touch the **[TONE]** key to display the TONE tab screen.
- 3-2. Touch the **[TREBLE]** key.
- 3-3. Touch the **[◀]** or **[▶]** key for the desirable type to adjust to a desirable level.
 - GAIN:** -6 to 6
 - The factory default setting is "0".
 - FREQ:** 8kHz, 12kHz
 - The factory default setting is "12kHz".

Adjusting the Balance/Fader

- 3-1. Touch the **[BAL/FAD]** key to display the BAL/FAD tab screen.
- 3-2. Touch the **[▲]** or **[▼]** key to adjust to the fader level.
 - [▲]:**
Emphasizes the sound from the front speakers.
 - [▼]:**
Emphasizes the sound from the rear speakers.
Adjustment range: front 12 to rear 12
 - The factory default setting is "0".
- 3-3. Touch the **[◀]** or **[▶]** key to adjust to the balance level.
 - [◀]:**
Emphasizes the sound from the left speakers.
 - [▶]:**
Emphasizes the sound from the right speakers.
Adjustment range: left 12 to right 12
 - The factory default setting is "0".

Adjusting the Non-Fader output volume

You can adjust the volume output from the unit's non-fader output terminal.

- 3-1. Touch the **[OTHERS]** key to display the OTHERS tab screen.
- 3-2. Touch the **[-]** or **[+]** key of the NON FADER VOL item to adjust to desirable level.
 - Setting range: -6 to 6
 - The factory default setting is "0".

Turning on/off the Magna-Bass EXTend

The Magna Bass Extend does not adjust the low sound area like the normal sound adjustment function, but emphasizes the deep bass sound area to provide you with a dynamic sound.

- The factory default setting is "OFF"

Note:

- *This operation is disabled when the DZE (Digital Z-Enhancer) function is set to other than "OFF".*

- 3-1. Touch the **[OTHERS]** key to display the OTHERS tab screen.
- 3-2. Touch the **[ON]** or **[OFF]** key of the M-B EX item to turn the Magna Bass Extend function on or off.

Adjusting the High Pass Filter

You can adjust the cut-off frequency of the High Pass Filter for the front/rear speaker output.

- The factory default setting is "Through".

- 3-1. Touch the **[OTHERS]** key to display the OTHERS tab screen.
- 3-2. Touch the **[50Hz]**, **[80Hz]**, **[120Hz]**, or **[Through]** key of the HIGH PASS FILTER item to adjust setting.

Adjusting the Low Pass Filter

You can adjust the cut-off frequency of the Low Pass Filter for the non-fader output.

- The factory default setting is "Through".

- 3-1. Touch the **[OTHERS]** key to display the OTHERS tab screen.
- 3-2. Touch the **[50Hz]**, **[80Hz]**, **[120Hz]**, or **[Through]** key of the LOW PASS FILTER item to adjust setting.

Setting the Amp Cancel

When an external amplifier is used, using this function reduces power noises of the audio lines.

- The factory default setting is "OFF".

- 3-1. Touch the **[OTHERS]** key to display the OTHERS tab screen.
- 3-2. Touch the **[ON]** or **[OFF]** key of the AMP CANCEL item to turn the Amp Cancel function on or off.

General Settings

Displaying the General Settings screen

You can customize the various settings of this unit from the General Settings screen.

1. Press the **[MENU]** button.
The Menu screen appears.
2. Touch the **[General]** key.
The General Settings screen appears.



3. Touch the desired Tab key, and perform the adjustment.
See the following sections for details.
 - In the following sections, only the details regarding adjustments are described, procedures to select items are skipped.
4. When the adjustment completes, touch the **[Back]** key to return to the previous screen.

Setting Camera Interrupt

When the optional CCD camera is connected to this unit, the rear view image is displayed on the screen when the gear lever is put in the reverse gear position.

- The factory default setting is **"OFF"**.
- 3-1. Touch the **[Display]** key to display the Display tab screen.
 - 3-2. Touch the **[ON]** or **[OFF]** key of the Camera Interrupt item to turn the Camera Interrupt function on or off.

Setting Camera Warning

The following warning message is displayed during use of the CCD camera: "Make sure of safety around your vehicle".

- The factory default setting is **"ON"**.

Note:

- This setting is disabled when the Camera Interrupt feature is set to OFF.

- 3-1. Touch the **[Display]** key to display the Display tab screen.
- 3-2. Touch the **[ON]** or **[OFF]** key of the Camera Warning item to turn the Camera Warning function on or off.

Setting the VTR system (NTSC/PAL)

- The factory default setting is **"NTSC"**.
- Note:**
- This setting is applied only to the AUX video input.
- 3-1. Touch the **[Display]** key to display the Display tab screen.
 - 3-2. Touch the **[NTSC]** or **[PAL]** key of the NTSC/PAL item to set the VTR system.

Setting the Auto Panel

When you remove or attach the DCP (Detachable Control Panel), you can set the liquid crystal panel automatically housing or opening.

- The factory default setting is **"ON"**.
- 3-1. Touch the **[Display]** key to display the Display tab screen.
 - 3-2. Touch the **[ON]**, **[OFF]**, or **[Close]** key of the Auto PANEL item to set to **"ON"**, **"OFF"**, or **"Close"**.

[ON]:

The liquid crystal panel houses automatically after removing the DCP. And the liquid crystal panel opens automatically after attaching the DCP.

[OFF]:

Normal operation.

[Close]:

The liquid crystal panel houses automatically after removing the DCP.

Setting the time of air conditioner operation mode (HVAC)

This setting can be used to adjust the time the panel stays in the horizontal position when in the air conditioner operation mode.

- The factory default setting is **"10 seconds"**.
- 3-1. Touch the **[Display]** key to display the Display tab screen.
 - 3-2. Touch the **[✔]** key to display the next screen.
 - 3-3. Touch the **[5s]**, **[10s]**, or **[30s]** key of the HVAC item to set the time to **"5 seconds"**, **"10 seconds"**, or **"30 seconds"**.

Setting the Beep

The sound heard when you make operations is called “beep”. The system can be set so that it does not produce this beep sound.

- The factory default setting is “ON”.

- 3-1. Touch the **[System]** key to display the System tab screen.
- 3-2. Touch the **[ON]** or **[OFF]** key of the Beep item to turn the Beep function on or off.

Setting the Blink LED

You can set the unit to blink the Blink LED indication when the DCP (Detachable Control Panel) is removed.

- The factory default setting is “OFF”.

- 3-1. Touch the **[System]** key to display the System tab screen.
- 3-2. Touch the **[ON]** or **[OFF]** key of the Blink LED item to turn the Blink LED function on or off.

Confirming the DivX Registration Code and DivX URL

When you download a DivX VOD (Video-on-Demand) file from a web site, entering the registration code of your playback system may be required to authorize the file. You can confirm the registration code of your system and the URL information by the following operation.

- 3-1. Touch the **[System]** key to display the System tab screen.
- 3-2. Confirm the displayed information of the DivX Registration Code and DivX URL items.

Note:

- *The DivX registration code is not displayed when a disc is set in the DVD player.*

Performing the System Check

You can perform the system check by the following operation.

- 3-1. Touch the **[System]** key to display the System tab screen.
- 3-2. Touch the **[✔]** key to display the next screen.
- 3-3. Touch the **[Check]** key of the System Check item.
A confirmation screen is displayed.

- 3-4. Touch the **[Yes]** key to perform the system check manually.
The system will be restarted after performing the system check.

Setting the Audio ATTenuation

The audio output can be attenuated when a voice interrupt of the navigation system arises.

- The factory default setting is “Low”.

Note:

- *This setting is enabled only when the Navigation System is connected to this unit.*

- 3-1. Touch the **[System]** key to display the System tab screen.
- 3-2. Touch the **[✔]** key to display the next screen.
- 3-3. Touch the **[High]**, **[Mid]**, **[Low]**, or **[Mute]** key of the Audio ATT item to set the volume level when a voice interrupt arises.

Changing the Wall Paper

You can change the wall paper (background image on the most screens) by selecting it from the Wall Paper tab screen.

- 3-1. Touch the **[Wall Paper]** key to display the Wall Paper tab screen.
- 3-2. Touch the desired Wall Paper key you wish to set.
The background image of the screen will be changed to the selected image.

Adjusting the Clock

- The time is displayed in 12-hour format.

Note:

- *This setting is disabled when the Navigation system is connected. The clock is automatically adjusted using the CT (clock time) data in the GPS data.*

- 3-1. Touch the **[Clock]** key to display the Clock tab screen.
- 3-2. Touch the **[▲]**, **[▼]**, **[am]**, and **[pm]** keys under the hour, minute, and am/pm box to adjust the time, then touch the **[Set]** key (The factory default setting is “1:00 am”).

Adjusting the Monitor

You can customize the various monitor settings by the following operations.

Setting the Screen mode

The system has two screen modes: the Day mode and Night mode. Each mode has the own dimmer setting. You can select these modes temporarily by performing the following operation. This setting will automatically return to the Auto mode when turning the car lights on/off or turning off the ignition switch.

- The factory default setting is "Auto".
1. Press the **[MENU]** button to display the Menu screen.
 2. Touch the **[Day]**, **[Night]**, or **[Auto]** key to set the Screen mode.
 - [Day]:**
Set the dimmer level temporarily to the Day mode (brighter).
 - [Night]:**
Set the dimmer level temporarily to the Night mode (dimmer).
 - [Auto]:**
The dimmer level is changed according to the status of the car light:
When the car light is off: Day mode
When the car light is on: Night mode
 3. Touch the **[Back]** key to return to the previous screen.

Note:

- When the navigation system is connected, this setting also works upon the Color mode of the navigation system.

Adjusting the Dimmer, Bright, Color, Contrast, and Hue level

Note:

- The Bright, Color, Contrast, and Hue settings can be adjusted only when a video image is displayed on the screen, and the car is stopped with applying the parking brake.
- The Hue setting can be adjusted only when the NTSC mode is selected.
- The navigation screen has own dimmer setting separately from the AV screen. The dimmer adjustment in a mode does not affect each other screen.
- The CCD camera image cannot be adjusted directly. Perform the adjustments when displaying a video image of the other source.

1. Press the **[MENU]** button to display the Menu screen.

2. Touch the **[Monitor]** key to display the Monitor Settings screen.



3. Touch the **[Dimmer]**, **[Bright]**, **[Color]**, **[Contrast]**, or **[Hue]** key you wish to adjust, then touch the **[◀]** or **[▶]** key to adjust the level.
 - [Dimmer]:**
Adjusts the panel brightness when the car lights are ON or OFF.
 - [▶]:** Press to make image brighter.
 - [◀]:** Press to make image dimmer.
 - [Bright]:**
Adjusts the brightness of the display.
 - [▶]:** Press to make image brighter.
 - [◀]:** Press to make image dimmer.
 - [Color]:**
Adjusts the color saturation.
 - [▶]:** Press to increase color depth.
 - [◀]:** Press to decrease color depth.
 - [Contrast]:**
Adjusts the contrast of the display.
 - [▶]:** Press to make contrast higher.
 - [◀]:** Press to make contrast lower.
 - [Hue]:**
Adjusts the tone of color (red is emphasized or green is emphasized).
 - [▶]:** Press to increase green.
 - [◀]:** Press to increase red.
4. When the adjustment completes, touch the **[Back]** key to return to the previous screen.

8. TROUBLESHOOTING

General

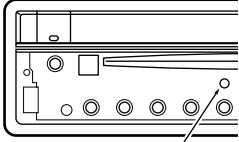
Problem	Cause	Measure
Power does not turn on. (No sound is produced.)	Fuse is blown.	Replace with a fuse of the same amperage. If the fuse blows again, consult your store of purchase.
	Incorrect wiring.	Consult your store of purchase.
Nothing happens when buttons are pressed. Display is not accurate.	The microprocessor has malfunctioned due to noise, etc.	<p>Turn off the power and remove the DCP. Press the reset button with a thin rod.</p> <p>Note: When the Reset button is pressed, turn off the ACC power.</p>  <p>Reset button</p> <ul style="list-style-type: none"> When the Reset button is pressed, frequencies of radio stations, etc. stored in memory are cleared.
The remote control unit does not work.	Direct rays of the sun fall on the light-receptive part of the remote control unit.	When direct rays of the sun fall on the light-receptive part of the remote control unit, it may not work.
	The battery of the remote control unit is dead or there is no battery in the remote control unit.	Check the battery of the remote control unit.
The display is dark.	The Dimmer control is too low.	Adjust the Dimmer properly.
	The operating condition is not good.	The temperature inside the vehicle may be 0°C or lower. Set to an appropriate temperature (25°C or so) and check it again.
	The headlight of the vehicle is lit.	The display is made dark at night to prevent the glare (when the headlight is lit in the daytime, the display gets dark).
There are red, green and blue points in the display.	_____	This is not a failure, but a phenomenon peculiar to a liquid crystal panel (The liquid crystal panel is produced according to technology with very high precision. Note that, though there are effective pixels of 99.99% or more, pixel missing or normally lit pixels account for 0.01%).

DVD Player

Problem	Cause	Measure
Disc cannot be loaded.	Another disc is already loaded.	Eject the disc before loading the new one.
	There is a foreign matter already in place.	Eject the foreign matter forcibly.
Sound skips or is noisy.	Disc is dirty.	Clean the disc with a soft cloth.
	Disc is heavily scratched or warped.	Replace with a disc with no scratches.
	MP3/WMA/AAC files are not encoded properly.	Use MP3/WMA/AAC files encoded properly.
Sound is bad directly after power is turned on.	Water droplets may form on the internal lens when the car is parked in a humid place.	Let dry for about 1 hour with the power on.
The image is not displayed.	The parking brake is not engaged.	Check that the parking brake is engaged.
Disc cannot play with the display "PARENTAL VIOLATION" shown.	The view is limited.	Release the view limitation or change the parental level. See the subsection "Setting up the parental level" (page 31).
Disc cannot play with the display "NO DATA" shown.	No MP3/WMA/AAC/DivX file is recorded on the disc.	Write these files properly onto a disc.
	File system is not correct.	Use ISO9660 level 1/2, Romeo, Joliet, or Apple ISO file system for CD-R/RW, or UDF for DVD±R/RW.
The color of the display is light or a shade of color is not good.	The color is not adjusted adequately.	Check that the Bright, Color, Contrast, and Hue are adjusted properly.

USB Devices

Problem	Cause	Measure
USB device cannot be inserted.	The USB device has been inserted with wrong direction.	Reversing the connection direction of the USB device, try it again.
	The USB connector is broken.	Replace with a new USB device.
USB device is not recognized.	The USB device is damaged.	Disconnect the USB device and reconnect. If the device is still not recognized, try replacing with a different USB device.
	Connectors are loose.	
No sound heard with the display "NO FILE" shown.	No MP3/WMA/AAC file is stored in the USB device.	Store these files properly in the USB device.
Sound skips or is noisy.	MP3/WMA/AAC files are not encoded properly.	Use MP3/WMA/AAC files encoded properly.
The iPod's video image is disturbed.	The TV Signal setting of the iPod is not set correctly.	Set the TV Signal setting (NTSC/PAL) of the iPod correctly.

9. ERROR DISPLAYS

If an error occurs, one of the following displays is displayed.
Take the measures described below to solve the problem.

DVD Player

Display	Cause	Measure
ERROR 2	A disc is caught inside the DVD player and is not ejected.	This is a failure of DVD player's mechanism. Consult your store of purchase.
ERROR 3	A disc cannot be played due to scratches, etc.	Replace with a non-scratched, non-warped disc.
ERROR 6	A disc is loaded upside-down inside the DVD player and does not play.	Eject the disc then reload it properly.
PARENTAL VIOLATION	Parental level error	Set the correct Parental level.
WRONG REGION	Region code error	Eject the disc, and replace correct region code disc.
DRM	WMA files protected by DRM are played.	Perform the operation such as skipping a file. (Repeat and random playback mode may be canceled.)
NOT SUPPORT	Files not supported by this unit are played.	

USB Devices

Display	Cause	Measure
ERROR 2	The connected USB device is not supported.	Connect a proper USB device.
ERROR 3 (MTP player/USB memory)	An error occurred when controlling the USB device.	Disconnect the USB device, and reconnect it again.
ERROR 3 (iPod)	The selected category has no track data.	Press the [▶▶] button. If the error is not cleared, disconnect the iPod, and reconnect it again.
	The iPod is frozen.	Disconnect the iPod, reset it, and reconnect it again.
ERROR 5 (iPod/MTP player)	The connected USB device is not recognized.	Disconnect the USB device, and reconnect it again. If the USB device is still not recognized, try replacing with a different USB device.
		If the USB device is frozen, disconnect it, reset it, and reconnect it again.

Display	Cause	Measure
BUS ERROR	Over-current or data error is detected.	Turn off the ignition switch, disconnect the device, restart the engine and reconnect it again. If the device is still not recognized, try replacing with a different device.
DEVICE ERROR	The device is connected via the USB Hub.	Disconnect the device, and reconnect directly to the USB connector of this unit without using the USB Hub.
DRM	WMA files protected by DRM are played.	Perform the operation such as skipping a file. (Repeat and random playback mode may be canceled.)
NOT SUPPORT	Files not supported by this unit are played.	

If an error display other than the ones described above appears, press the Reset button. If the problem persists, turn off the power and consult your store of purchase.

- When the Reset button is pressed, frequencies of radio stations, etc. stored in memory are cleared.

10. SPECIFICATIONS

FM Tuner

Frequency Range: 87.9 MHz to 107.9 MHz
Usable Sensitivity: 9 dBf
50dB Quieting Sensitivity: 15 dB
Alternate Channel Selectivity: 70 dB
Stereo Separation (1 kHz): 35 dB
Frequency Response (± 3 dB): 30 Hz to 15 kHz

AM Tuner

Frequency Range: 530 kHz to 1710 kHz
Usable Sensitivity: 28 dB μ V

DVD Player

System:
Digital Versatile Disc System with CDDA capable
Usable discs:
DVD video disc, Compact disc
Frequency Response:
20 Hz to 20 kHz (CD) (± 1 dB)
Dynamic Range: 100 dB (1 kHz)
Distortion: 0.01%

USB

Specification: USB 2.0 Full Speed
File system: FAT12/16/32
Playable audio format:
MP3 (.mp3): MPEG1/2 Audio Layer-3
WMA (.wma): Ver. 7/8/9.1/9.2
AAC (.m4a): AAC format encoded by iTunes and iTunes+ only
Maximum number of folders: 512
Maximum number of files: 255 (for a folder)
Maximum folder hierarchy: 8 levels (including Root)
Rights management: Windows Media DRM 10 supported
Maximum power supply: 500 mA

Bluetooth

Specification: Bluetooth Ver. 1.2
Profile:
HFP (Hands-Free Profile)
OPP (Object Push Profile) Phone Book
A2DP (Advanced Audio Distribution Profile)
AVRCP (Audio/Video Remote Control Profile)
Send/Receive Sensitivity: Class 2

Audio Amplifier

Maximum power output:
200 W (50 W \times 4)
Speaker impedance: 4 Ω (4 to 8 Ω allowable)

Input

Audio input sensitivity:
High: 0.65 V (at 2 V output)
Mid: 1.3 V (at 2 V output)
Low: 2.0 V (at 2 V output)
(input impedance 10 k Ω or greater)
Video input:
1.0 \pm 0.2 Vp-p (input impedance 75 Ω)

Video Output

Video output:
1.0 \pm 0.2 Vp-p (output impedance 75 Ω)

LCD Monitor

Screen Size: 7-inch wide type
6" Width (152 mm) \times 3-5/16" Height (85 mm)
Display method:
Transmission type TN liquid crystal display
Drive method: TFT (thin-film transistor)
active matrix driving
Pixels: 336,960 (1440 \times 234)

General

Power source voltage:
14.4 V DC (10.8 to 15.6 V allowable)
Ground: Negative
Current consumption: 4.0 A (1 W)
Auto Antenna Rated Current: 500 mA less
Dimensions of the Main Unit:
7" Width (178 mm) \times 1-15/16" Height (50 mm) \times 6-1/2" Depth (165 mm)
Weight of the Main Unit: 2.4 kg
Dimensions of the Remote Control Unit:
1-3/4" Width (43.4 mm) \times 1/2" Height (12.5 mm) \times 4-1/2" Depth (112.7 mm)
Weight of the Remote Control Unit:
60 g (including battery)

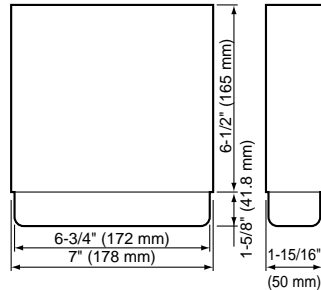

Note:

- Specifications comply with JEITA Standards.
- Specifications and design are subject to change without notice for further improvement.

Power Output:

19 W \times 4 Channels RMS [4 Ω @
14.4 V \leq 1 % THD+N]

Signal to Noise Ratio:

78 dBA (reference: 1 W into 4 Ω)



INSTALLATION AND WIRE CONNECTION MANUAL

■ Contents

1. SAFETY PRECAUTIONS	70
2. BEFORE STARTING	72
3. PACKAGE CONTENTS	72
4. GENERAL CAUTIONS	72
5. CAUTIONS ON INSTALLATION	73
6. INSTALLING THE MAIN UNIT	74
7. REMOVING THE MAIN UNIT	76
8. CAUTIONS ON WIRING	76
9. WIRE CONNECTION	77
10. SAMPLE SYSTEM	80

1. SAFETY PRECAUTIONS

The Installation and Wire Connection Manual is intended for authorized Clarion dealers. Due to the complexity of the vehicle's wiring and components, it is recommended an authorized Clarion dealer perform the installation. For the location of nearest authorized Clarion dealer, please visit: www.clarion.com

For your safety, the Owner's Manual should be read thoroughly to familiarize yourself with controls and functionality.

Symbol Identification

This manual uses symbols and icons to indicate safety precautions and concerns during the installation procedure. Be sure to carefully read and understand each precaution prior to beginning the installation.

⚠ WARNING

This symbol is intended to alert the user to the presence of important operating instructions. Failure to heed the instructions may result in severe injury or death.

⚠ CAUTION

This symbol is intended to alert the user to the presence of important operating instructions. Failure to heed the instructions can result in injury or material damage.

Before Use

⚠ WARNING

- Confirm the battery voltage of the vehicle to be installed. This unit is designed only for vehicles with DC 12V power supply.
- Disconnect the negative terminal of the battery before connecting wires, otherwise an electric shock, injury by short circuit may occur.

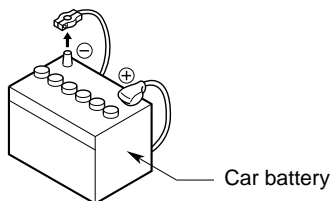

Installation Precautions

⚠ WARNING

- When installing the unit to a vehicle with an airbag system, never install it in a place where it may affect the operation of the airbag.
- Do not install this unit in the following locations:
 - A location interfering with the driver's visual range or operation.
 - A location where the gear shift or brake pedal are hindered.
 - A location where passengers are at risk.
 - An unstable location, or where the system may fall.

⚠ CAUTION

- Do not install the system in the locations described below. This may cause a fire, accident or electrical shock:
 - A location exposed to rain or dust.
 - A location interfering with the driver's visual range or operation of the vehicle.
 - An unstable location, or where the system may fall.
- Do not install this unit in a place exposed to direct sunlight, heat or a place where the vent holes or heat radiation holes are covered.
- When you install the antenna, mount it in a place where the elements of the antenna do not protrude beyond the edge of the front, back, left and right of the vehicle.
- If it comes in contact with pedestrians, it may cause an accident.

Installation Notes

⚠ WARNING

- Please note the position of pipes, tanks and electrical wirings before installing the unit into the vehicle; failure in avoiding these may cause a fire or malfunction.

⚠ CAUTION

- Use only the supplied parts.
- If unspecified parts are used, they may cause damage.
- Any holes made in the body of the vehicle should be sealed with a silicon adhesive.
- If exhaust fumes or water penetrates into the vehicle, this may cause an accident.
- Fasten the bolts securely when installing the unit. If the bolts are loose an accident or malfunction could occur.

Connection Notes

⚠ WARNING

- Loom all cables according to the instruction manual, so as not to hinder operation.
- Wire the connecting cords/cables away from high temperature areas. If the coatings of the cables melt, it could cause an accident/fire by a short circuit. Take care when wiring in the engine compartment.
- When wiring the connecting cables in a vehicle with an airbag system, never feed the cables through a place where it may affect the operation of the airbag.
- An airbag not operating correctly in an emergency may cause increased injury.

⚠ CAUTION

- Verify wires with a digital multi-meter prior to making any connections. Many new vehicles use multiplexed and/or low voltage circuits that can be damaged if a test light or logic probe is used.
- Connect cables appropriately. If a wrong connection is made, this may cause a fire or accident.
- When passing cables through the body of the vehicle, use non-conductive grommets.
- If the coatings of the cables are worn out by rubbing, this may cause an accident, fire or a short circuit.
- After wiring cables, fix them with insulation tape.
- Be sure to switch off the vehicle when connecting or disconnecting cords to/from the unit, otherwise an electric shock, injury or accident may occur.

2. BEFORE STARTING

1. This set is exclusively for use in cars with a negative ground 12 V power supply.
2. Read these instructions carefully.
3. Be sure to disconnect the battery "⊖" terminal before starting. This is to prevent short circuits during installation. (Figure 1)

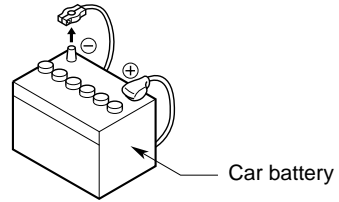

Figure 1

3. PACKAGE CONTENTS

- | | |
|--------------------------------------|-------------------------------|
| ① Main unit | ⑥ Bag for accessories (No. 2) |
| ② Manuals | Hook plate 2 |
| Owner's manual & Installation manual | Cord clamp |
| Warranty card | ⑦ Bag for accessories (No. 3) |
| ③ Power supply cord | Rca cap 12 |
| ④ Rca pin cord | ⑧ Universal mounting bracket |
| ⑤ Bag for accessories (No. 1) | ⑨ Remote control unit |
| Flat head screw (M5 × 8) 4 | ⑩ Battery |
| Sems hexagonal bolt (M5 × 8) 5 | (for remote control unit) |
| Electro tap | ⑪ Outer Escutcheon |
| Machine screw (M4 × 3) 4 | ⑫ DCP Case |

4. GENERAL CAUTIONS

1. Do not open the case. There are no user-serviceable parts inside. If you drop anything into the unit during installation, consult your dealer or an authorized Clarion service center.
2. Use a soft, dry cloth to clean the case. Never use a rough cloth, thinner, benzine, or alcohol, etc. For tough dirt, apply a little cold or warm water to a soft cloth and wipe off the dirt gently.

5. CAUTIONS ON INSTALLATION

1. Prepare all articles necessary for installing the main unit before starting.
2. This model features a liquid crystal panel that slides forward (shell loading system). On some types of cars, the liquid crystal panel may make contact with the dashboard or gearshift lever, in which case it cannot be installed. Before installing, check that the unit will not hamper operation of the gearshift lever or obstruct your view before selecting the installation location. (Figure 2)

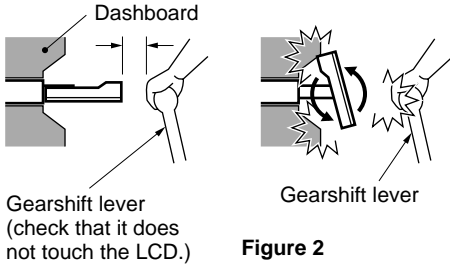

3. Install the unit within 30° of the horizontal plane. (Figure 3)

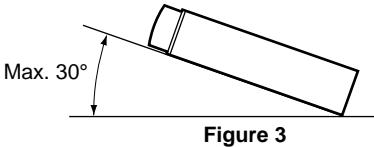

4. If you have to do any modification on the car body, such as drilling holes, consult your car dealer beforehand.

5. Use the included screws for installation. Using other screws can cause damage. (Figure 4)

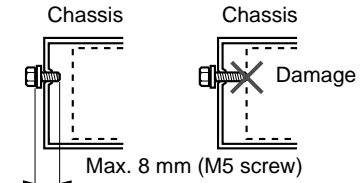

6. The source unit has mounting screw holes for NISSAN (N marks) and TOYOTA (T marks) vehicles. (Figure 5)

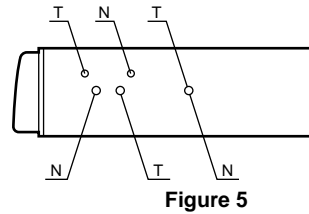

6. INSTALLING THE MAIN UNIT

Universal Mount

1. Place the universal mounting bracket into the instrument panel, use a screwdriver to bend each stopper of the universal mounting bracket inward, then secure the stopper as shown in Figure 6.
2. Wire as shown in Section 9 (see page 77).
3. Insert the main unit into the universal mounting bracket until it locks.
4. Mount the outer escutcheon so that all the hooks are locked.

Note:

- Some car models require special mounting kits for proper installation. Consult your Clarion dealer for details.
- Fasten the front stopper securely to prevent the main unit from coming loose.

• Console opening dimensions

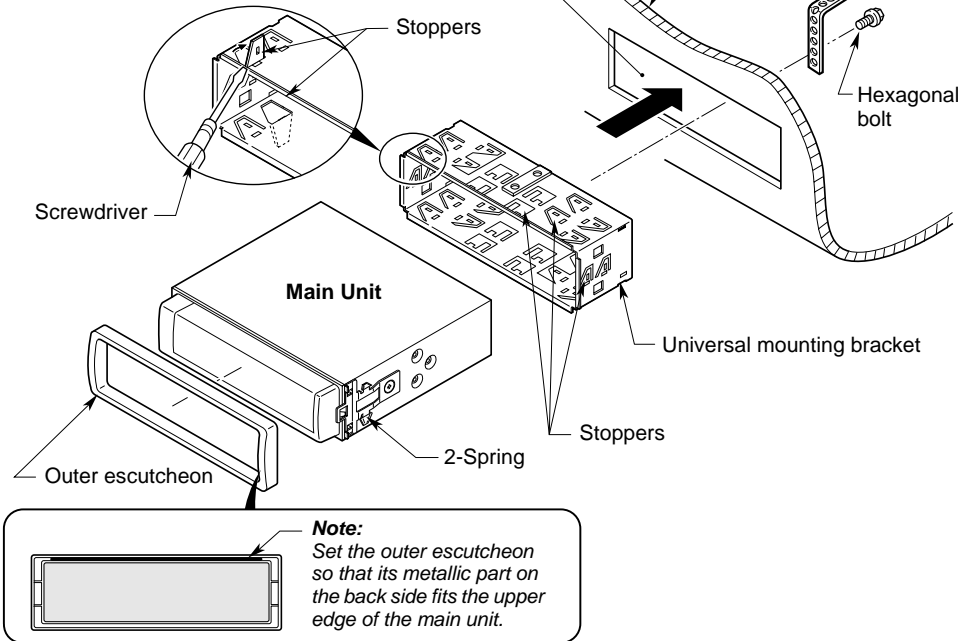
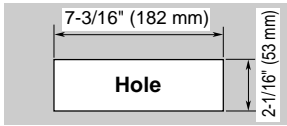

Figure 6

Fixed Mount (TOYOTA, NISSAN and other ISO/DIN equipped vehicles)

This unit is designed for fixed installation in the dashboard.

If the vehicle is equipped with a factory-installed radio, install the main unit with the parts and screws marked (*2). (Figure 8)

If the vehicle is not equipped with a factory-installed radio, obtain an installation kit to install the main unit in the following procedure.

1. Remove the screws from both side of the main unit. Then, at either side, lift the leaf spring until the engaging claws are released from the holes, and slide the spring to the direction of arrow to remove it. Repeat the same for the other side to remove the springs from the both sides. (Figure 7)

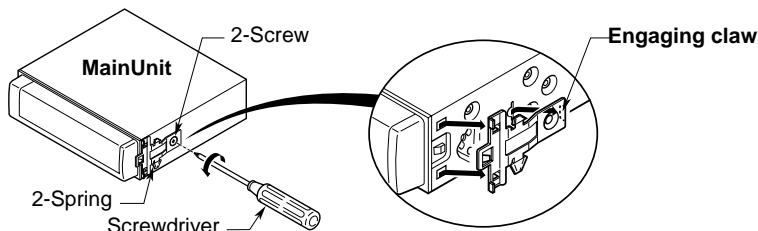

Figure 7

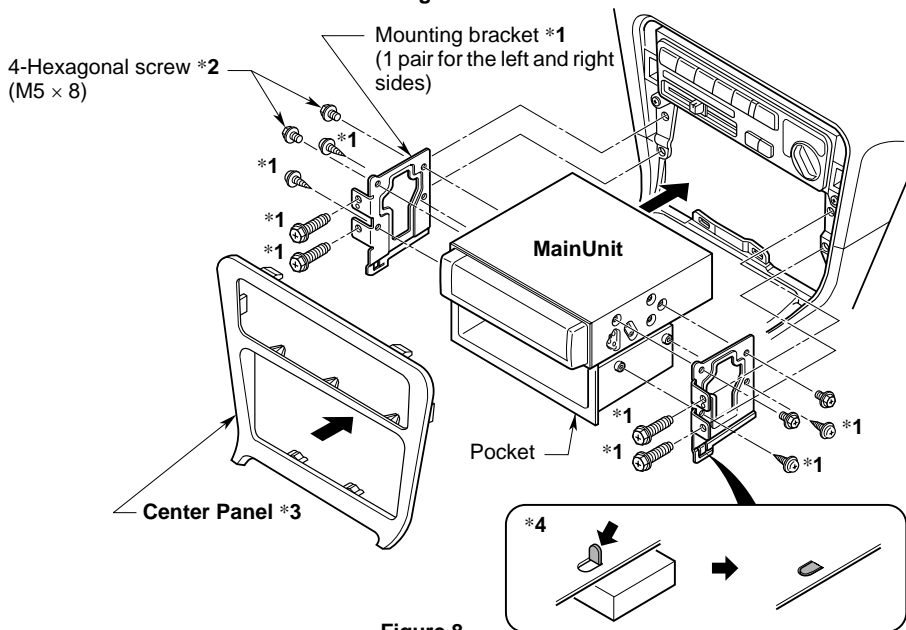

Figure 8

Note:

- *1 The parts and screws with this mark are used to install radio or included in the installation kit.
- *2 The screws with this mark are enclosed in this set.
- *3 In some cases, the center panel may require some modification (trimming, filling, etc.).
- *4 If the hook on the installation bracket interferes with the unit, bend and flatten it with a nipper or a similar tool.

7. REMOVING THE MAIN UNIT

1. When the rear of the main unit has been secured with the method shown in Figure 6 unfasten the special screw.
2. Remove the outer escutcheon.
3. Insert the hook plate between the spring and the universal mounting bracket, fit tab **(B)** of the spring into hole **(A)** of the hook plate, then pull the main unit out by the hook plate. (Insert both the right and left edges of the hook plate.) (Figure 9)

Note:

- Keep the hook plate. You cannot remove the main unit without disengaging the hook plate.

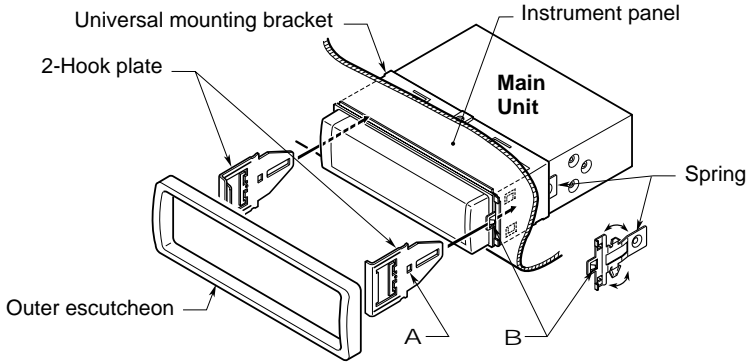

Figure 9

8. CAUTIONS ON WIRING

1. Be sure to turn the power off before wiring.
2. Be particularly careful where you route the wires. Keep them well away from the engine, and exhaust pipe, etc. Heat may damage the wires.
3. If the fuse should blow, check to see if the wiring is correct. If a fuse is blown, replace it with a new one of the same amperage rating as the original (15A FUSE).
4. To replace the fuse, remove the old fuse of the power supply cord and insert the new one. (Figure10)

Note:

- There are various types of fuse holder. Do not let the battery side touch other metal parts.

CAUTION

After the connection, fix the cord by a clamp or insulation tape for protection.

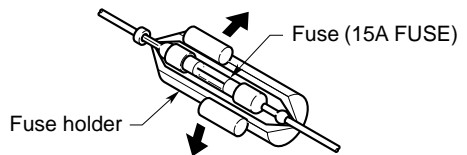
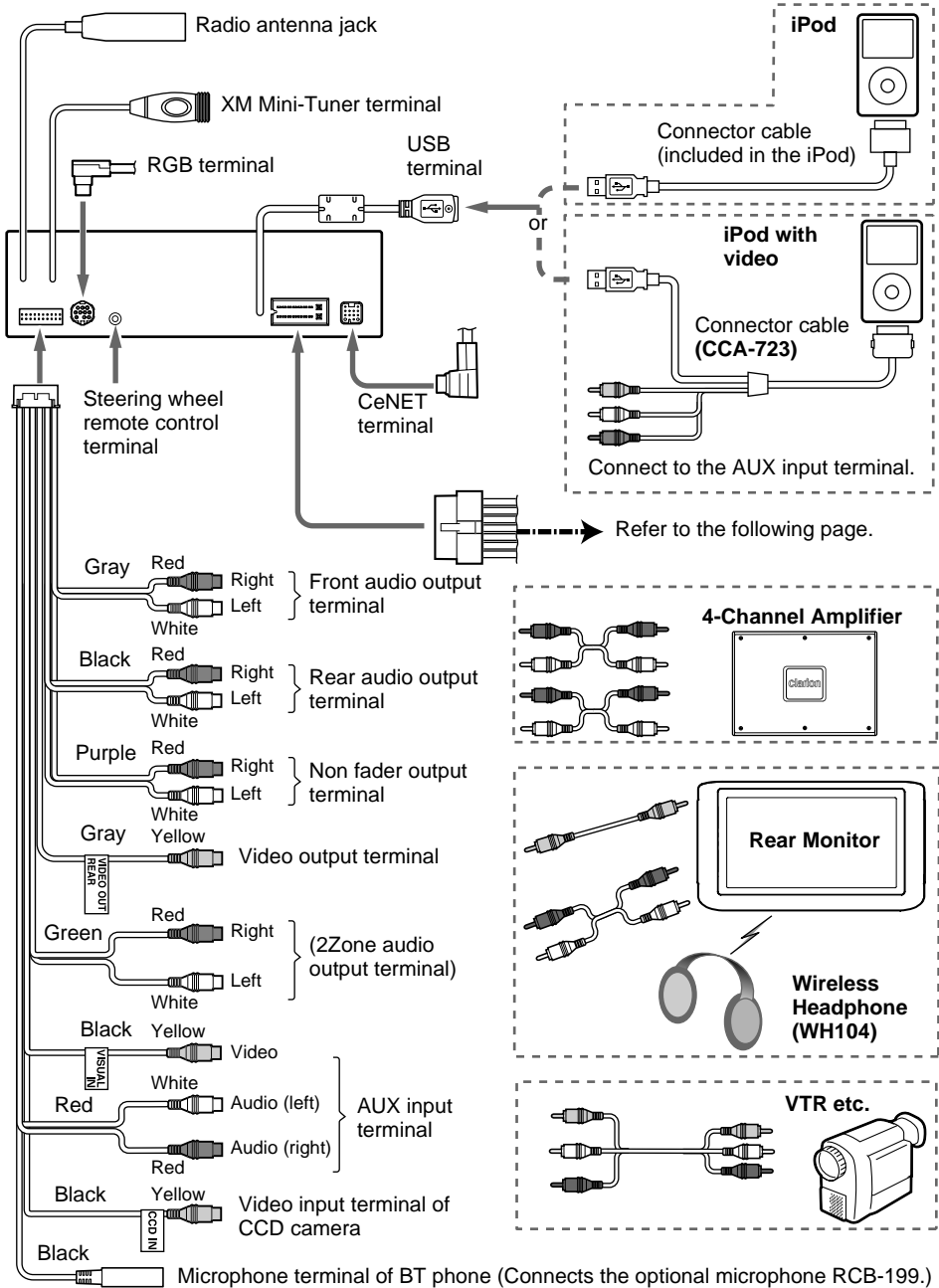

Figure 10

9. WIRE CONNECTION

Note:

- Before installing, be sure to disconnect the negative ⊖ cable of the car battery.
- In the optional devices, the RCA Pin and the Connector cable are separately-sold items.



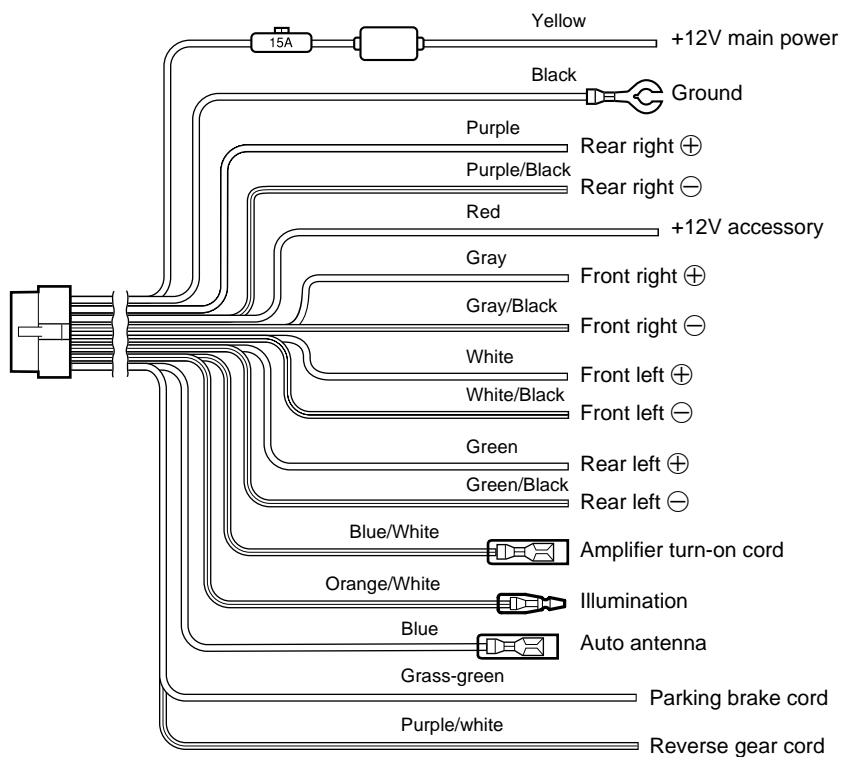

See next page for how to connect the parking brake cord.

●Connecting the parking brake cord

Connect the cord to parking brake lamp ground in the meter panel.

Note:

- Connecting the parking brake cord to lamp ground allows you to watch video images when the parking brake is engaged.
- When the parking brake cord is not connected, the monitor will not display video images.
- If "AUDIO ONLY" appears on the screen just after turning on the ACC power of the car, release the parking brake while confirming safety, and then engage the parking brake again.

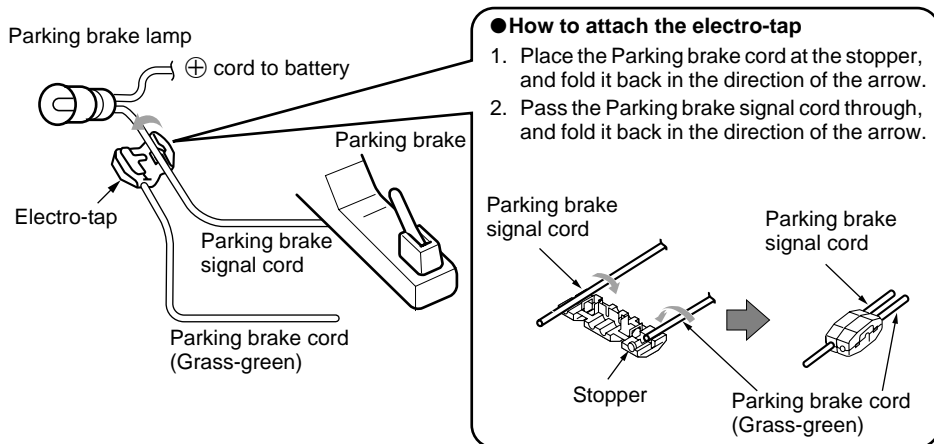

Connecting the Accessories

●Connection to the CCD camera for vehicle

The CCD camera for vehicle can be connected to CCD camera video input terminal of the RCA pin cord. For detailed information, refer to the instruction sheet or manual for the CCD camera.

Note:

- Be sure to connect the reverse gear cord to the vehicle's relevant terminal.
- Connect the CCD camera to the RCA pin cord; if not, the screen turns black while the gearshift lever is in the reverse gear position.
- A power supply box (sold separately) is required for connection of the main unit and the CCD camera.
- The power supply box for the camera CAA147 cannot be used. Please use the CAA188 instead.

●XM Mini-Tuner

For detailed information, refer to the instruction manual of the XM Mini-Tuner.

●Navigation System (NAX980HD/NAX970HD)

When the Navigation System is to be connected, connect the CeNET connector and the RGB terminal. For detailed information, refer to the instruction manual of the Navigation System.

10. SAMPLE SYSTEM

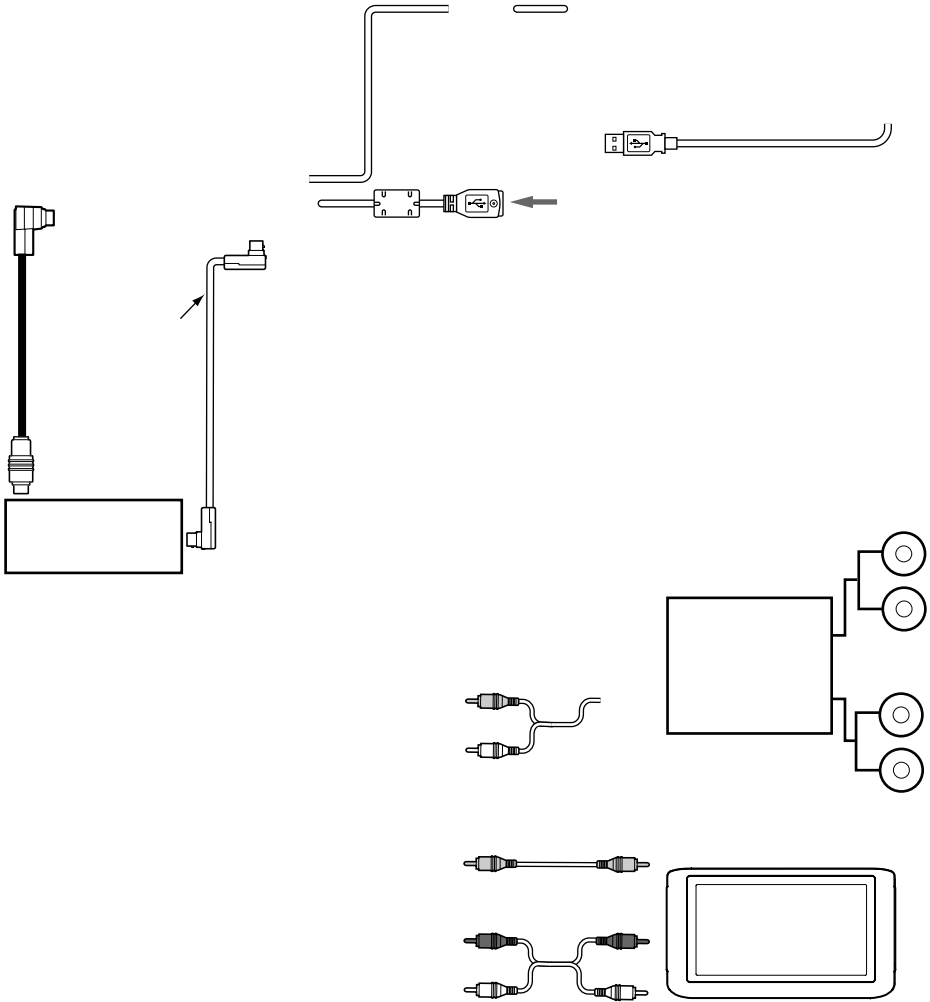

This device complies with Part 15 of the FCC Rules. Operation is subject to the following two conditions:

- (1) this device may not cause harmful interference, and
- (2) this device must accept any interference received, including interference that may cause undesired operation.

This Class B digital apparatus complies with Canadian ICES-003.
Cet appareil numérique de la classe B est conforme à la norme NMB-003 du Canada.



Clarion Co., Ltd.

All Rights Reserved. Copyright © 2008: Clarion Co., Ltd.
Printed in China / Imprimé en Chine / Impreso en China