



Owner's manual & Installation manual
Mode d'emploi et manuel d'installation
Manual de instrucciones y de instalación

MAX675VDII

**2-DIN DVD MULTIMEDIA STATION WITH CeNET &
7-inch TOUCH PANEL CONTROL**
**STATION MULTIMEDIA DVD 2 DIN AVEC COMMANDE
PAR ECRAN TACTILE 7 pouces & CeNET**
**EQUIPO DVD MULTIMEDIA 2-DIN CON CeNET y
PANEL DE CONTROL TÁCTIL DE 7 pulgadas**

CLARION PRODUCT REGISTRATION INFORMATION

For USA and Canada only
www.clarion.com

Dear Customer:

Congratulations on your purchase of a Clarion mobile electronic product. We are confident that you'll enjoy your Clarion experience.

There are many benefits to registering your product. We invite you to visit our website at www.clarion.com to register your Clarion product.

We have made product registration simple with our easy to use website. The registration form is short and easy to complete. Once you're registered, we can keep you informed of important product information.

Register at www.clarion.com - it's easy to keep your Clarion product up to date.

Contents

1. FEATURES	3
Expanding Systems.....	3
2. PRECAUTIONS	4
3. CONTROLS/COMMANDES/CONTROLES	5
Names of Buttons	6
Outline of Button and Touchkey Operation	7
Remote Control	13
Functions of Remote Control Unit Buttons	14
4. CAUTIONS ON HANDLING	17
Operation panel/Generalities	17
Cleaning	17
Handling Discs	18
5. DVD VIDEO SYSTEM	19
DVD Video Features	19
Discs.....	20
About the registered marks etc.	20
6. OPERATIONS.....	21
Basic Operations	21
Radio Operations	30
DVD Video Player Operations.....	32
Other Functions	45
7. ACCESSORIES	47
iPod Operations.....	47
VISUAL Operations	50
CD Changer Operations.....	50
TV Operations	52
Satellite Radio Operations.....	54
NAVI Operations	57
5.1 ch Surround Decoder Operations.....	59
8. TROUBLESHOOTING.....	63
9. ERROR DISPLAYS.....	65
10. SPECIFICATIONS	66
INSTALLATION AND WIRE CONNECTION MANUAL.....	67

TUNER mode operation

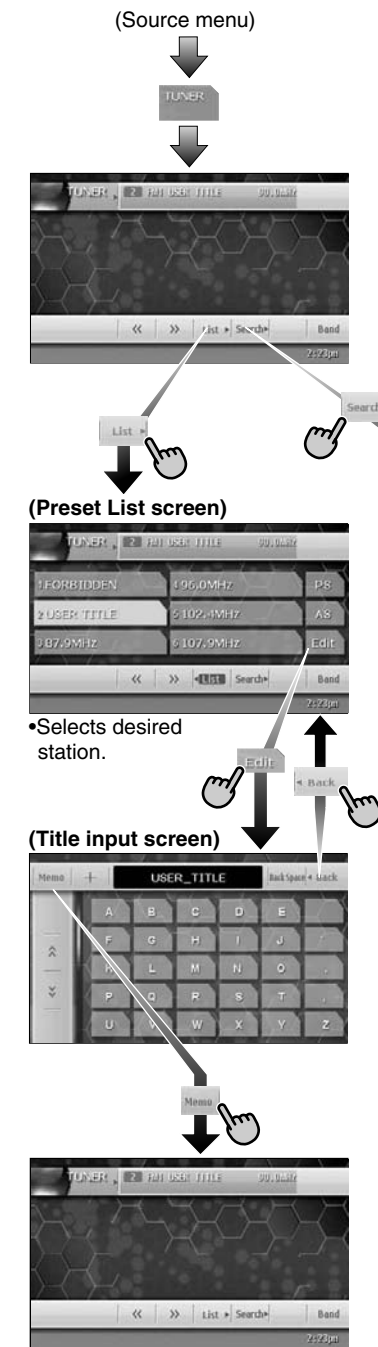

•Selects desired station.

•Enters desired frequency.

1 → 0 → 7 → 9 → ENT *3

Note:

*1:These images indicate the buttons to press or keys to touch.

*2:External equipment not connected with CeNET is not displayed.

*3:This shows an example entering 107.9 MHz.

1. FEATURES

- Double Din Motorized 7" Widescreen LCD
 - Touch Panel Control
 - DVD Video/Video CD/CD-DA/MP3/WMA Play Capability
 - RCA 6(+2)-Channel (2-zone) Output
 - Built-in 50 W × 4 Amplifier
 - CeNET with Balanced Audio Line Transmission and Dynamic Noise Canceling
 - CD-R/CD-RW/DVD±R/DVD±RW Compatible
 - 5.1 Channel Decoder for DTS and Dolby Digital Ready
 - Optical Digital Output
 - 2-ZONE Control
 - iPod® Control
- *iPod® is a trademark of Apple Computer, Inc., registered in the U.S. and other countries.



Expanding Systems

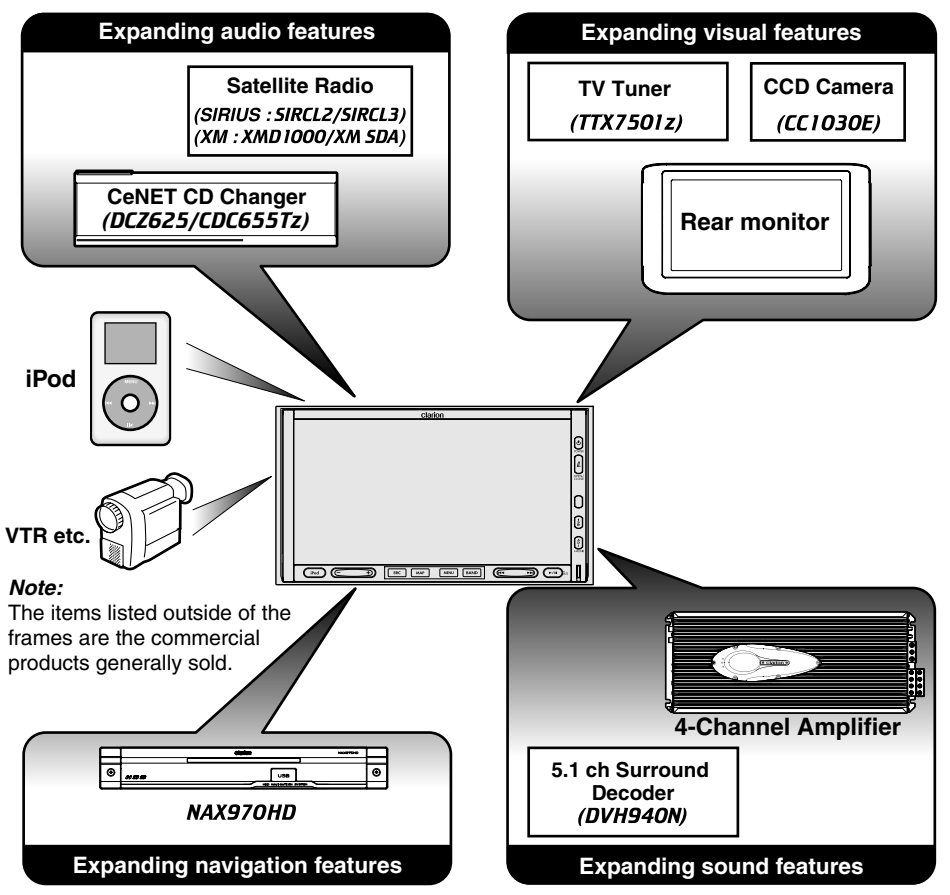

Note:
The items listed outside of the frames are the commercial products generally sold.

2. PRECAUTIONS

WARNING

For your safety, the driver should not watch the DVD video/TV/VTR or operate the controls while driving. Please note that watching and operating the DVD video/TV/VTR while driving are prohibited by law in some countries. Also, while driving, keep the volume to a level at which external sounds can be heard.

- When the inside of the car is very cold and the player is used soon after switching on the heater, moisture may form on the disc (DVD/CD) or the optical parts of the player and proper playback may not be possible. If moisture forms on the disc (DVD/CD), wipe it off with a soft cloth. If moisture forms on the optical parts of the player, do not use the player for about one hour. The condensation will disappear naturally allowing normal operation.
- Driving on extremely bumpy roads which cause severe vibration may cause the sound to skip.
- This unit uses a precision mechanism. Even in the event that trouble arises, never open the case, disassemble the unit, or lubricate the rotating parts.
- TV broadcast reception (when the optional TV tuner is connected)
When receiving the TV broadcast, the strength of the signals changes since the car is moving, so in some cases it may not be possible to receive clear pictures.
 - TV signals are strongly linear, so reception is affected by buildings, mountains and other obstacles.
 - External factors such as electric train lines, a high voltage lines, and signal devices may disturb the picture or cause noise.

* If the reception is poor, switch to a station with good reception.
- This equipment has been tested and found to comply with the limits for a Class B digital device, pursuant to Part 15 of the FCC Rules. These limits are designed to provide reasonable protection against harmful interference in a residential installation. This equipment generates, uses, and can radiate radio frequency energy and, if not installed and used in accordance with the instructions, may cause harmful interference to radio communications. However, there is no guarantee that interference will not occur in a

particular installation. If this equipment does cause harmful interference to radio or television reception, which can be determined by turning the equipment off and on, the user is encouraged to consult the dealer or an experienced radio/TV technician for help.

INFORMATION FOR USERS:
CHANGES OR MODIFICATIONS TO THIS PRODUCT NOT APPROVED BY THE MANUFACTURER WILL VOID THE WARRANTY AND WILL VIOLATE FCC APPROVAL.

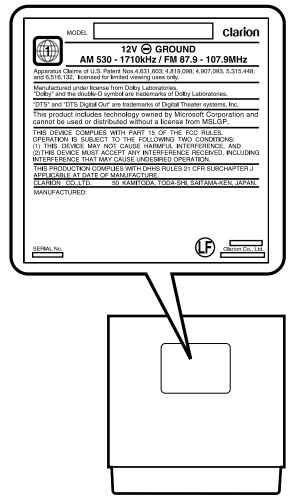

Be sure to unfold and read the next page.
Veuillez déplier et vous référer à la page suivante.
Cerciórese de desplegar y de leer la página siguiente.

3. CONTROLS/COMMANDES/CONTROLES

● Operation panel / Panneau de commande / Panel de funcionamiento

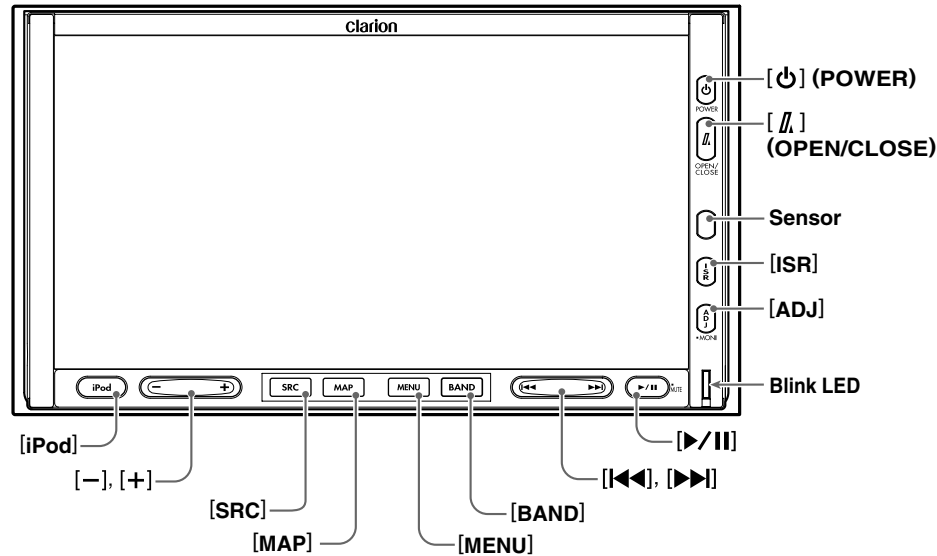

● With the operation panel open / Avec le panneau de commande ouvert / Con el panel de funcionamiento abierto

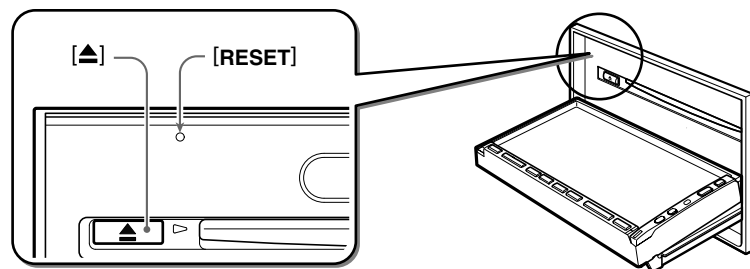

Note : Be sure to unfold this page and refer to the front diagrams as you read each chapter.
Remarque : Veuillez déplier cette page et vous référer aux schémas quand vous lisez chaque chapitre.
Nota : Cuando lea los capítulos, despliegue esta página y consulte los diagramas.

Names of Buttons

Note:
 • Be sure to read this chapter while referring to the front diagrams for chapter "3. CONTROLS" on page 5 (unfold).

[⏻] (POWER) button
 • Press this button to turn on the power. Keep pressing this button more than 1 second to turn off the power.
 • Press this button to turn off the back light of the liquid crystal panel.

[//] (OPEN/CLOSE) button
 • Use this button to open/close the operation panel.
 • Keep pressing this button more than 2 seconds to adjust the angle of the operation panel. The angle of the operation panel is adjustable in the range of 0° to 30°.

Sensor
 • Receiver for the remote control unit (operating range: 30° in all directions).

[ISR] button
 • Use this button to enter/exit the ISR (Instant Station Recall) standby mode.
 • Keep pressing this button more than 2 seconds to store the current station into ISR memory in the TUNER mode.
 * The [ISR] button is disabled when the SUB zone is selected in the 2-ZONE mode.

[ADJ] button
 • Press this button to enter/exit the ADJUST mode to change the settings.
 • Keep pressing this button more than 1 second to enter/exit the Monitor Adjust mode.

Blink LED
 • When the BLINK LED function is set to "ON" from the GENERAL menu in the ADJUST mode, blinks when the ACC power is turned off.

[▶/||] button
 • Press this button to enter the play pause mode in the DVD PLAYER/iPod/changer modes. Press the button again to resume playback.
 • Keep pressing this button more than 1 second to mute the sound in the DVD PLAYER/iPod/changer modes.
 • Press this button to mute the sound in the TUNER/Satellite Radio/TV/VISUAL modes.

[◀◀], [▶▶] buttons
 • Use these buttons to change to the previous/next preset station in the TUNER/Satellite Radio/TV modes.
 • Use these buttons to select a track in the CD, Video CD, MP3/WMA, iPod and CD changer modes.
 • Use these buttons to select a chapter in the DVD video mode.

[BAND] button
 • Press this button to switch the receiving bands for TUNER/Satellite Radio/TV modes. Keep pressing this button more than 1 second to switch the Seek/Manual tuning modes.
 • Use this button to move to the first track in the CD, Video CD and iPod modes, or the first chapter in the DVD video mode.
 • Use this button to move to the next folder in the MP3/WMA mode.
 • Use this button to switch to the next disc in the changer modes.
 • Keep pressing this button more than 1 second to play all tracks in the iPod mode.

[MENU] button
 • Pressing this button in the Navigation mode shows the Menu screen of the Navigation system.
 • When the menu screen of a DVD video/Video CD is displayed, pressing this button displays the Key Pad on the screen. When the other screen than the menu screen is displayed, keep pressing this button more than 1 second to display the Key Pad.
 • When displaying the GENERAL menu screen in the ADJUST mode, keep pressing this button more than 2 seconds to display a screen for entering your personal code of the anti-theft function.

[MAP] button
 • Press this button to show the Map screen of the current location in the Navigation mode.
 • Pressing this button in the audio/visual modes changes to the Navigation mode.
 • Pressing this button switches the display to a Visual input screen to lock the monitor (To enable this function, go to the GENERAL menu (within the ADJUST menu), and touch the [CONNECT] key, and select the desired item other than "NONE").

[SRC] button
 • Press this button to display the Source menu screen to switch the mode.

[+], [-] buttons
 • Use these buttons to increase/decrease the volume.

[iPod] button
 • Press this button to switch to the iPod mode.

[▲] (EJECT) button
 • Use this button to eject the disc set in this unit.

Outline of Button and Touchkey Operation

Turning the power on

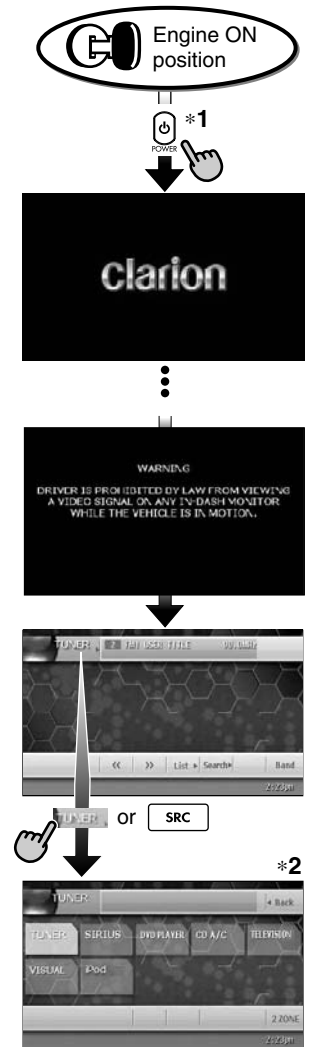
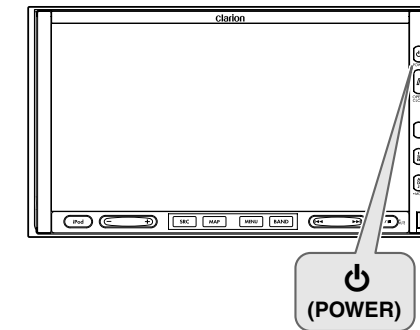

•You can change the media sources.

System check

The CeNET format utilized on this unit is provided with a system check function. When the system check function is performed under the following conditions, the power is automatically turned off. Press the [⏻] (POWER) button again.

- When power is first turned on after initial installation.
- When an external device is connected or disconnected.
- When Reset button is pressed.

*In addition to the above conditions, the system check function can be performed from the GENERAL menu in the ADJUST mode.

DVD Video mode operation

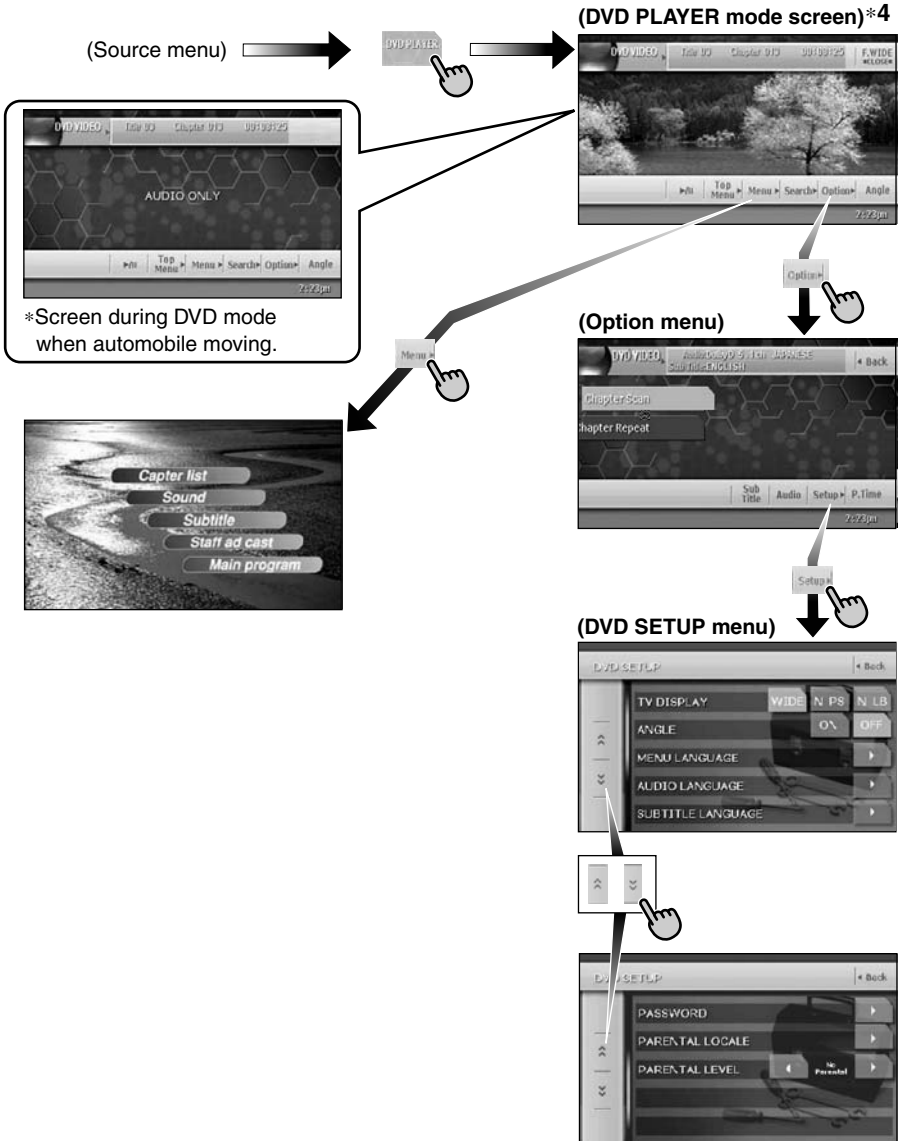

Note:

*4:When displaying movies in DVD video mode, touching the screen surface will cause the DVD PLAYER mode screen to be displayed.

Outline of Button and Touchkey Operation

Adjusting audio feature settings

- When no surround decoder is connected

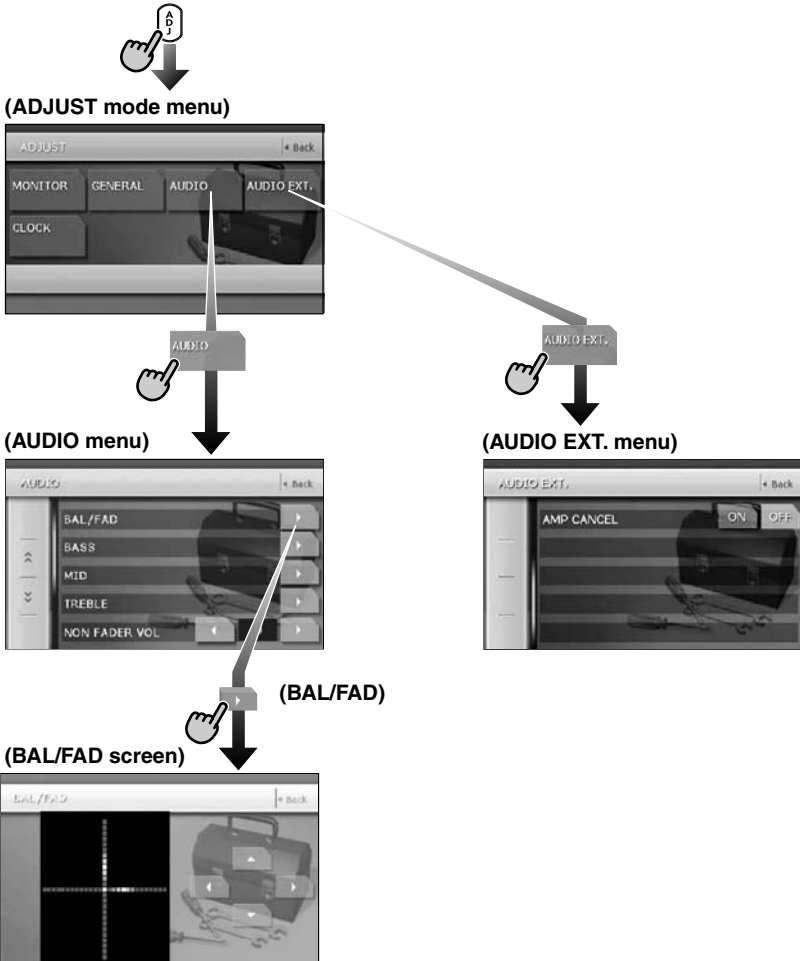

● When the 5.1 ch Surround Decoder is connected

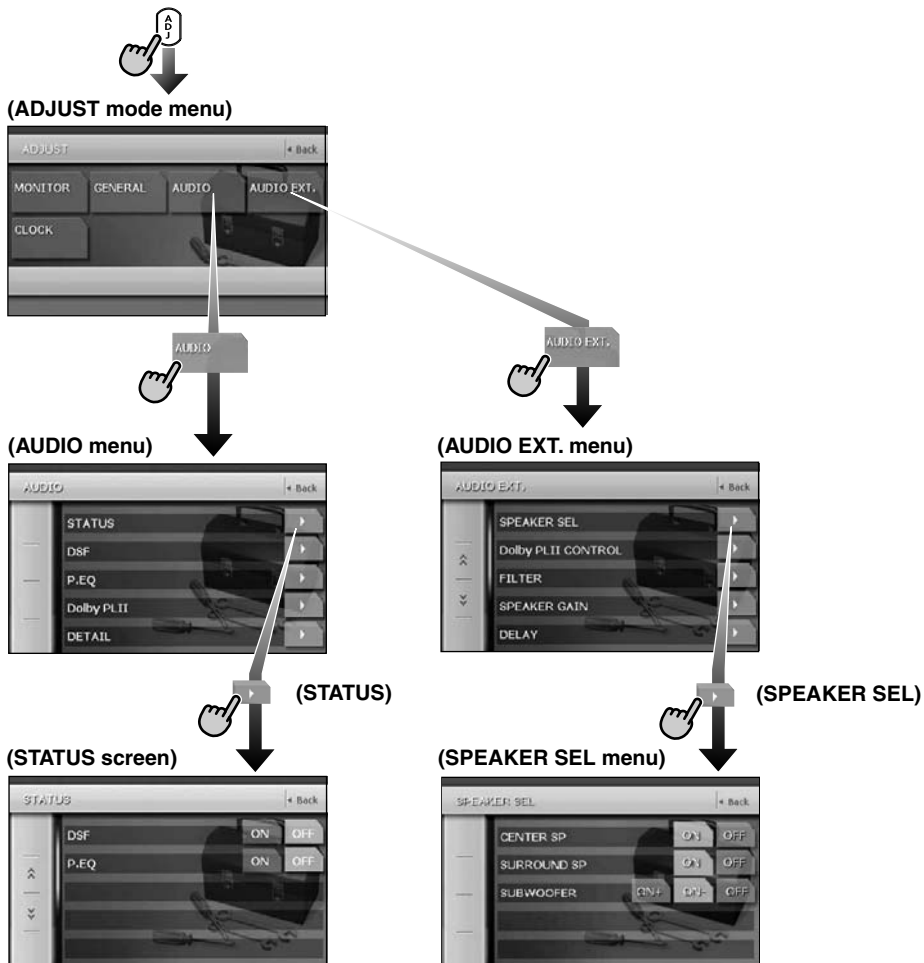

Outline of Button and Touchkey Operation

Adjusting the other system settings

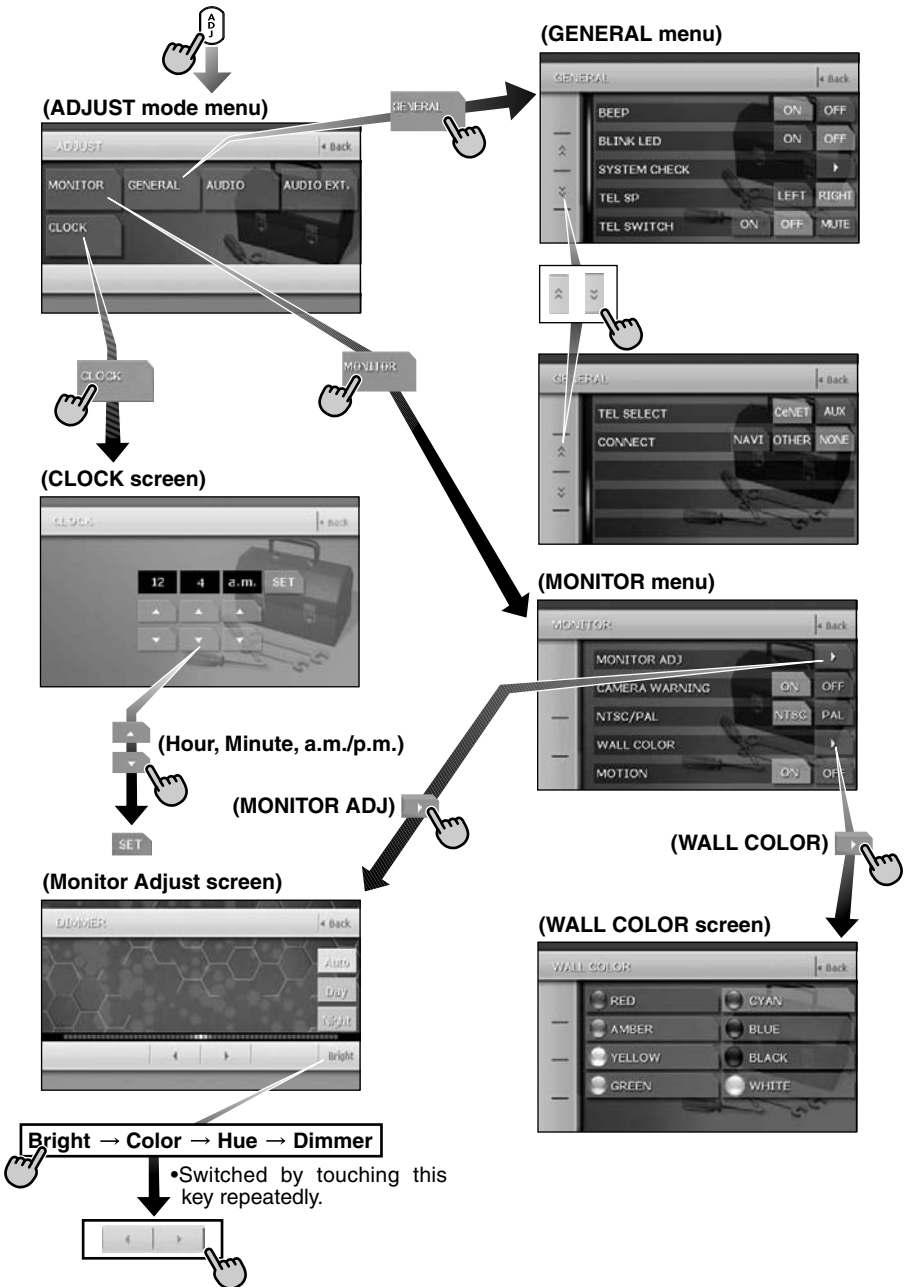

Remote control unit

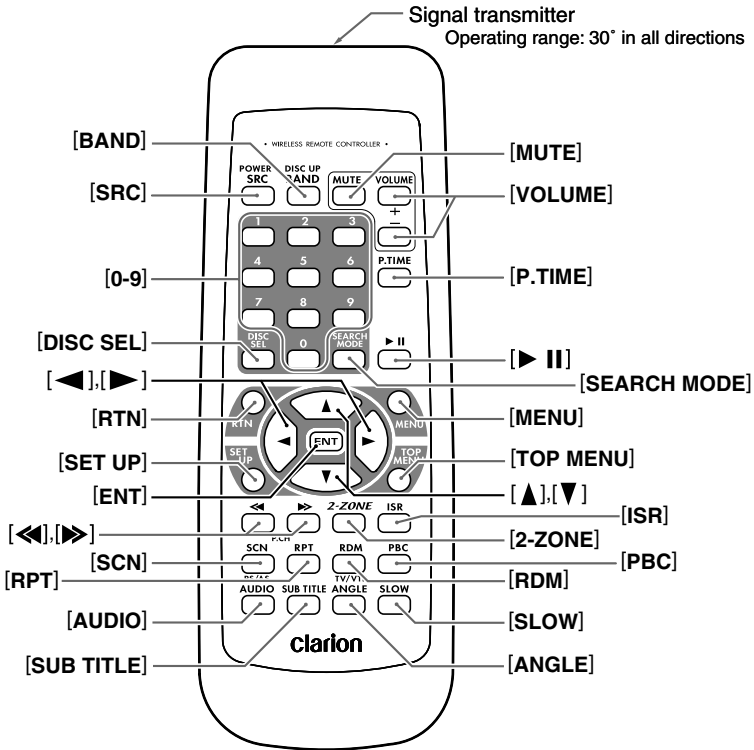

Inserting the Batteries

1. Slide the rear cover in the direction of the arrow, and remove it.
2. Insert the AA (SUM-3, IECR-6/1.5V) batteries bundled with the remote control unit in the directions shown in the figure, then close the rear cover.

Note:

Using batteries improperly can cause them to explode. Take note of the following points:

- When replacing batteries, replace both batteries with new ones.
- Do not short-circuit, disassemble or heat batteries.
- Do not dispose of batteries into fire or flames.
- Dispose of spent batteries properly.

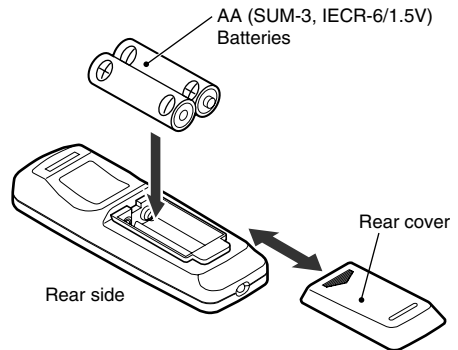

Functions of Remote Control Unit Buttons

You can use the remote control unit to control the MAX675VDII. When the 2-ZONE function is ON, the controls work upon the selected zone.

Note:

- The steering wheel remote control operations work upon the MAIN zone even when the SUB zone is selected.

Shared modes

[SRC] button

- Press this button to turn on the power. Keep pressing this button more than 1 second to turn off the power.
- Press this button to switch the modes such as TUNER mode, DVD PLAYER mode.

[VOLUME] buttons

- Increase and decrease volume.

[MUTE] button

- Turns mute on and off.

[RTN] button

- Returns to the previous screen from the list or menu screens.
- Displays the menu screen when playing a Video CD.

[2-ZONE] button

- Keep pressing more than 1 second to turn on the 2-ZONE, and keep pressing again to turn off 2-ZONE.
- Press to switch between the MAIN zone and SUB zone when the 2-ZONE is turned on.

TUNER/TV/Satellite Radio mode

[BAND] button

- Switches reception band.
- Keep pressing more than 1 second to switch the Seek/Manual tuning modes.

[0 - 9] buttons

- Use in the Key Pad screen to set the radio frequency or TV/Satellite Radio channels.
- Use to select the preset number in the Preset List screen.

[DISC SEL] button

- Press to show/hide the Preset List screen.

[SEARCH MODE] button

- Press to show/hide the Key Pad screen.

[ENT] button

- Press to fix the entered data in the Key Pad screen.

[◀], [▶] buttons

- Press to select the next higher or lower preset station in TUNER and TV/Satellite Radio modes.

[SCN] button

- Press to perform preset scans in the TUNER and TV/Satellite Radio modes. For the Satellite Radio mode, keep pressing more than 1 second.
- Press to perform category scans in the Satellite Radio mode.
- Keep pressing more than 1 second to perform the auto store operation in the TUNER and TV modes.

[ISR] button

- Recall ISR radio station in memory.
- Keep pressing more than 2 seconds to store current station into ISR memory (TUNER mode only).

[RDM] button

- Press to switch between TV mode and VTR mode.

DVD PLAYER mode

[BAND] button

- Press to return to the first chapter in DVD video mode.
- Press to return to the first track in CD and Video CD modes when playing back.
- Press to move to the next folder when more than 1 folder are played back in MP3/WMA mode.

[P.TIME] button

- Press to turn on and off the playtime display in the DVD video/Video CD modes.

[▶ II] button

- Press to play or pause video and audio media.
- Keep pressing more than 1 second to stop video playback in DVD video.

[0 - 9] buttons

- Press to enter DVD video chapters/titles in the Key Pad screen.
- Press to set the track/folder number of the CD, Video CD or MP3/WMA in the Key Pad screen.

[DISC SEL] button

- Press to show/hide the Track List screen in the CD mode.
- Press to show/hide the Folder List screen in the MP3/WMA mode.

[SEARCH MODE] button

- Press to display the Key Pad operation screen.
- Keep pressing more than 1 second to switch the search mode.

[RTN] button

- Press to switch to the menu screen while a Video CD is being played back. Press to switch to the previous screen display while the Menu screen is being displayed. However, it may occur that this button operation dose not work on some discs.

[MENU] button

- Press to display menu stored on video disc.

[SET UP] button

- Press to show the DVD SETUP menu screen during DVD video playback.

[TOP MENU] button

- Press to display the Top Menu screen stored on DVD video disc. Some discs do not display the top menu screen.

[▲], [▼], [◀], [▶] buttons

- Press to select button items on the menu screen of a DVD video.
- Press [▲], [▼] to scroll the Track/Folder List screen in the CD and MP3/WMA modes.

[ENT] button

- Press to fix the entered data in the Key Pad screen.
- Press to fix the selected item in the menu screens.

[◀], [▶] buttons

- Press to select the next higher or lower chapter number in DVD video mode.
- Press to select the next higher or lower track in CD, Video CD and MP3/WMA modes.
- Keep pressing to perform fast-forward and fast-backward.
- Keep pressing to perform slow playback while pausing a DVD video/Video CD play.

[SCN] button

- Press to perform chapter scans in the DVD video mode, and track scans in CD and MP3/WMA modes.
- Keep pressing more than 1 second to perform folder scans in MP3/WMA mode.

[RPT] button

- Press to perform chapter repeat in the DVD video mode, and track repeat in CD and MP3/WMA modes.
- Keep pressing more than 1 second to perform folder repeat in MP3/WMA mode.

[RDM] button

- Press to play tracks at random in CD and MP3/WMA modes.
- Keep pressing more than 1 second to play folders at random in MP3/WMA mode.

[PBC] button

- Press to turn on and off the PBC function in the Video CD mode.

[AUDIO] button

- Press to switch the AUDIO function in the DVD video/Video CD modes.

[SUB TITLE] button

- Press to display subtitles in the DVD video mode.

[ANGLE] button

- Press to switch the ANGLE function in the DVD video mode when the Angle mark is displayed. (This button is available only on multiple angles DVDs and when the ANGLE function in the SET UP menu is set to ON.)

[SLOW] button

- While the button is kept pressed, slow play is performed.

iPod mode

[BAND] button

- Press to return to the first track in the current play list.
- Keep pressing more than 1 second to change to the All play mode. All tracks in the Song list will be played back.

[▶ II] button

- Press to play or pause the selected media.

[▲], [▼] buttons

- Press to scroll the list screens.

[◀], [▶] buttons

- Press to select the next higher or lower track numbers.
- Keep pressing to perform fast-forward or fast-backward.

CD changer mode

[BAND] button

- Press to switch discs.

[DISC SEL] button

- Press to show/hide the Disc List screen.

[▶ II] button

- Press to play and pause the selected media.

Functions of Remote Control Unit Buttons

[0 - 9] buttons

- Press to enter track numbers in the Key Pad screen.
- Press to select the disc number in the Disc List screen.

[▲], [▼] buttons

- Press to scroll the Disc/Track List screen.

[◀], [▶] buttons

- Press to select the next higher or lower track numbers.
- Keep pressing to perform fast-forward or fast-backward.

[SCN] button

- Press to perform track scan.
- Keep pressing more than 1 second to perform disc scan.

[RPT] button

- Press to perform track repeat.
- Keep pressing more than 1 second to perform disc repeat.

[RDM] button

- Press to play tracks of all discs at random.
- Keep pressing more than 1 second to play folders of all discs at random.

When SUB zone is selected

SUB zone operations are supported, but button functions are limited as follows:

Shared modes

[VOLUME] buttons

- Controls sound volume for MAIN zone source.

[MUTE] button

- Controls audio mute function for MAIN zone source.

[ISR] button

Not supported.

CD changer mode

- This mode is disabled when MAIN zone is set to an external equipment other than the CD changer.

4. CAUTIONS ON HANDLING

Operation panel/Generalities

For a longer service life, be sure to read the following cautions.

- The operation panel will operate properly in a temperature range of 0 to 60°C.
- Do not allow any liquids on the set from drinks, umbrellas etc. Doing so may damage the internal circuitry.
- Do not disassemble or modify the set in any way. Doing so may result in damage.
- Subjecting the operation panel to shocks may result in breakage, deformation or other damage.
- Do not let cigarettes burn the display. Doing so may damage or deform the cabinet.
- If a problem should occur, have the set inspected at your store of purchase.
- Do not insert objects or poke in the space between the operation panel and the main unit when the panel is tilted.
- The remote control unit may not work if the remote control sensor is exposed to direct sunlight.
- In extremely cold weather, the display movement may slow down and the display may darken, but this is not a malfunction. The display will work normally when the temperature increases.
- Small black and shiny spots inside the liquid crystal panel are normal for LCD products.
- The touchkeys on the display operate when slightly touched. Do not press the touchkey screen with much force.
- Do not push the case surrounding the touchkey panel with much force. This may cause malfunctioning of the touchkeys.

Cleaning

Cleaning the cabinet

Use a soft, dry cloth and gently wipe off the dirt. For tough dirt, apply some neutral detergent diluted in water to a soft cloth, wipe off the dirt gently, then wipe again with a dry cloth.

Do not use benzene, thinner, car cleaner, etc., as these substances may damage the cabinet or cause the paint to peel. Also, leaving rubber or plastic products in contact with the cabinet for long periods of time may cause stains.

Cleaning the liquid crystal panel

The liquid crystal panel tends to collect dust, so wipe it off occasionally with a soft cloth. The surface is easily scratched, so do not rub it with hard objects.

Handling Discs

Handling

- New discs may have some roughness around the edges. If such discs are used, the player may not work or the sound may skip. Use a ball-point pen or the like to remove any roughness from the edge of the disc.

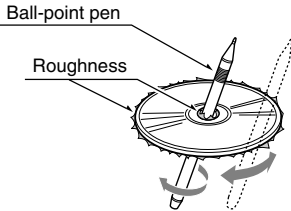

- Never stick labels on the surface of the disc or mark the surface with a pencil or pen.
- Never play a disc with any cellophane tape or other glue on it or with peeling off marks. If you try to play such a disc, you may not be able to get it back out of the DVD player or it may damage the DVD player.
- Do not use discs that have large scratches, are misshapen, cracked, etc. Use of such discs may cause misoperation or damage.
- To remove a disc from its storage case, press down on the center of the case and lift the disc out, holding it carefully by the edges.
- Do not use commercially available disc protection sheets or discs equipped with stabilizers, etc. These may damage the disc or cause breakdown of the internal mechanism.

Storage

- Do not expose discs to direct sunlight or any heat source.
- Do not expose discs to excess humidity or dust.
- Do not expose discs to direct heat from heaters.

Cleaning

- To remove fingermarks and dust, use a soft cloth and wipe in a straight line from the center of the disc to the circumference.
- Do not use any solvents, such as commercially available cleaners, anti-static spray, or thinner to clean discs.
- After using special disc cleaner, let the disc dry off well before playing it.

On Discs

- Exercise a good precaution when loading a disc. The operation panel will close automatically when leaving it open for a while.
- Never turn off the power and remove the unit from the car with a disc loaded.

⚠ CAUTION

For your safety, the driver should not insert or eject a disc opening the operation panel while driving.

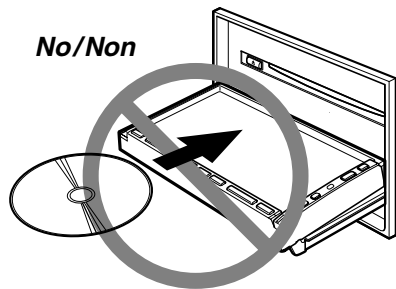

5. DVD VIDEO SYSTEM

DVD video is a high-quality digital video source that provides crisp and clear images. One 12 cm disc contains either one film or four hours of music.

DVD Video Features

This unit provides the following functions in addition to the high image quality and sound quality of DVD video.

Note:

- The functions described in this section, for example, the recorded language, subtitles, angles, etc. differ depending on the DVD video disc. Refer to the instructions provided with the DVD video.
- Some disc functions may operate differently from described in this manual.

Multi-sound function

DVD video can store up to 8 languages for one film; select the language of your preference.

- The languages stored on the disc are indicated by the icon shown below.



Multi-angle function

A DVD video that is filmed from multiple angles allows you to select the angle of choice.

- The number of recorded angles are indicated by the icon shown below.

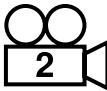

Subpicture (subtitles) function

A DVD video can record subtitles for up to 32 languages and you can select the language of the subtitles you wish to see.

- The number of recorded subtitle languages are indicated by the icon shown below.



Multi-story function

When a DVD video contains more than one story for a film, you can select the story you wish to enjoy. The operation procedures vary with the disc; observe the instructions for selecting a story provided during playback.

Dolby Digital

Dolby Digital enables up to 5.1 independent multi-channel audio reproduction, the same type of surround system that is used in movie theaters.

DTS

DTS (Digital Theater System) is a digital sound compression technique developed by Digital Theater Systems, Inc.

This low sound compression format delivers a large amount of data and makes it possible to reproduce a high quality sound.

Menu screens

Menus can be called up during DVD video playback to perform menu setting.

- Example showing menu display



Discs

Playable discs

This DVD video player can play the following discs.

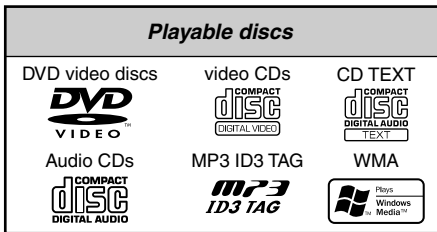

About CD Extra discs

A CD Extra disc is a disc in which a total of two sessions have been recorded. The first session is Audio session and the second session is Data session.

Your personally-created CDs with more than second data sessions recorded cannot be played on this DVD video player.

Note:

- When you play a CD Extra disc, only the first session will be recognized.

About playing a CD-R/CD-RW disc (MP3, WMA)

This player can play CD-R/CD-RW discs previously recorded in music CD format (MP3, WMA) or video CD format.

About playing a DVD-R/RW or DVD+R/RW disc

This player cannot play DVD-R/RW and DVD+R/RW discs previously recorded in video CD format.

However, MP3/WMA files recorded on DVD-R/RW and DVD+R/RW discs can be played.

About the registered marks etc.

- This product incorporates copyright protection technology that is protected by U.S. patents and other intellectual property rights. Use of this copyright protection technology must be authorized by Macrovision, and is intended for home and other limited viewing uses only unless otherwise authorized by Macrovision. Reverse engineering or disassembly is prohibited.
- Manufactured under license from Dolby Laboratories.

Discs that cannot be played back

This DVD video player cannot play back DVD-Audio, DVD-RAM, Photo CDs, etc.

Note:

- It may also not be possible to play back CDs recorded on a CD-R unit and CD-RW unit. (Cause: disc characteristics, cracks, dust/dirt, dust/dirt on player's lens, etc.)
- If a CD-R or CD-RW disc that has not been finalized is played, it will take a long time to start playing. Also, it may not be possible to play depending on its recording conditions.
- You cannot play Super Audio CDs. Playback of the CD player is not supported even if it is a hybrid disc.

About MP3/WMA playback

This unit can play back CD-R/CD-RW, DVD-R/RW and DVD+R/RW discs on which MP3/WMA music data have been recorded.

For a detailed information, see the section entitled "Listening to an MP3/WMA" (page 42).

Note on region numbers

The DVD video system assigns a region number to DVD video players and DVD discs by sales area. DVD video players sold in the United States can play back DVD discs with the region number "ALL", "1" or any combination of numbers that also incorporate a "1".

The DVD video region number is marked on the disc jacket as shown below.



- "Dolby", "Pro Logic" and the double-D symbol are trademarks of Dolby Laboratories.
- "DTS" and "DTS Digital Out" are trademarks of Digital Theater Systems, Inc.
- "iPod" is for legal or rightholder-authorized copying only. Do not steal music.
- Windows Media™, and the Windows® logo are trademarks, or registered trademarks of Microsoft Corporation in the United States and/or other countries.

6. OPERATIONS

Basic Operations

Note:

- Be sure to read this chapter referring to the chapter "3. CONTROLS" (page 5).

⚠ CAUTION

When the unit is turned on, starting and stopping the engine with its volume raised to the maximum level may harm your hearings. Be careful about adjusting the volume.

Turning on and off the power

Note:

- Start the engine before using this unit.
 - Be careful about using this unit for a long time without running the engine. If you drain the car's battery too far, you may not be able to start the engine and this can reduce the service life of the battery.
1. Start the engine. The illuminations on this unit light up.



Engine ON
position

2. Press the [⏻] (POWER) button to turn on the power.
 - * Pressing this button while the power is turned on turns off the back light of the liquid crystal panel.
3. To turn off the power, press and hold the [⏻] (POWER) button for more than 1 second.

Selecting a mode

1. Press the [SRC] button to display the Source menu.
 - * External equipment not connected to this unit is not displayed.
 2. Touch the desired mode key.
- **About the CT (Clock Time) display**
- When the Navigation system is connected, the displayed clock data is based on the CT (clock time) data in the GPS data.

Adjusting the volume

1. Press the [+]/[-] buttons to adjust the volume.
 - [+]: Increases the volume.
 - [-]: Decreases the volume.
 - The volume level indicated in the display is in a range from 0 (min.) to 33 (max.).

⚠ CAUTION

While driving, keep the volume level at which external sounds can be heard.

Mute

1. When in the TUNER, Satellite Radio, VISUAL or TV mode, press the [▶/■] button to turn the mute on and off.
 - When in the DVD PLAYER, iPod or changer mode, keep pressing the [▶/■] button more than 1 second to turn the mute on and off.
 - When the mute is turned on, "Ⓜ" appears at the bottom left of the screen.

Opening the operation panel and adjusting the angle

Open the operation panel when inserting/ejecting a disc.

The angle of the operation panel can be adjusted depending on the mounting angle of the unit or light coming into the car.

⚠ CAUTION

- Do not move the operation panel forcibly or do not apply strong force to the operation panel.
- When the operation panel is operating, be careful not to get your hand or finger caught between the operation panel and main unit or its mechanical parts.
- The driver should not operate the operation panel while driving.

Basic Operations

Opening/closing the operation panel

1. Press the [**⏏**] (OPEN/CLOSE) button.
The operation panel will be opened or closed.

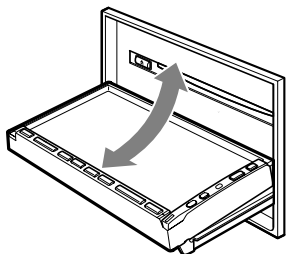

Note:

- The operation panel will close automatically when leaving it open for a while.
- When the operation panel is open, the touch panel cannot be operated.

Adjusting the angle of the operation panel

The angle of the operation panel can be adjusted in the range of 0° to 30°.

1. Keep pressing the [**⏏**] (OPEN/CLOSE) button more than 2 seconds.
Beeps will sound twice and the operation panel will start moving.

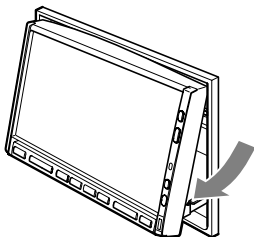

2. When the operation panel is moved to your desired angle, release the button.
The operation panel will stop.
 - * Once you adjust the angle of the operation panel, the operation panel will return to the adjusted angle even after it is open/closed.

Returning the operation panel to the original angle

1. Keep pressing the [**⏏**] (OPEN/CLOSE) button.
It will move, and stop at 30°.
2. Keep pressing the [**⏏**] (OPEN/CLOSE) button again.
It will move, and stop at 0°.

Adjusting the AUDIO

Note:

- When the optional 5.1 ch Surround Decoder (DVH940N) is used, the following tone adjustments cannot be made. To adjust the tone, refer to the section "5.1 ch Surround Decoder Operations" (page 59).

1. Press the [**ADJ**] button, then touch the [**AUDIO**] key.



2. Touch the item key to adjust.
3. Perform the adjustment.
See the following sections for detail.
4. Touch the [**Back**] key to return to the previous screen.
 - * In the following sections, only the details regarding adjustments are described, procedures to select items are skipped.

Adjusting the balance/fader

- 2-1. Touch the [**▶**] key of the **BAL/FAD** item.
- 3-1. Touch the [**▲**] or [**▼**] key to adjust to the fader level.
 - The factory default setting is "0".
(Adjustment range: front 12 to rear 12)

[**▲**]:
Emphasizes the sound from the front speakers.

[**▼**]:
Emphasizes the sound from the rear speakers.

- 3-2. Touch the [**◀**] or [**▶**] key to adjust to the balance level.
 - The factory default setting is "0".
(Adjustment range: left 13 to right 13)

[**◀**]:
Emphasizes the sound from the left speakers.

[**▶**]:
Emphasizes the sound from the right speakers.

Adjusting the BASS

The bass gain, bass frequency (center frequency) and bass Q can be adjusted as follows.

- 2-1. Touch the [▶] key of the BASS item.
- 3-1. When the AUDIO BASS screen is displayed, touch the [◀] or [▶] key for the desirable type to adjust to a desirable level.

GAIN:

-6 to 8 (The factory default setting is "0".)

FREQ.:

50Hz, 80Hz, 120Hz (The factory default setting is "50Hz".)

Q:

1, 1.25, 1.5, 2 (The factory default setting is "1".)

Adjusting the MID

The MID gain, MID frequency (center frequency) and MID Q can be adjusted as follows.

- 2-1. Touch the [▶] key of the MID item.
- 3-1. When the AUDIO MID screen is displayed, touch the [◀] or [▶] key for the desirable type to adjust to a desirable level.

GAIN:

-6 to 6 (The factory default setting is "0".)

FREQ.:

700Hz, 1kHz, 2kHz (The factory default setting is "1kHz".)

Q:

1.5, 2 (The factory default setting is "2".)

Adjusting the TREBLE

The treble gain and treble frequency can be adjusted as follows.

- 2-1. Touch the [▶] key of the TREBLE item.
- 3-1. When the AUDIO TREBLE screen is displayed, touch the [◀] or [▶] key for the desirable type to adjust to a desirable level.

GAIN:

-6 to 6 (The factory default setting is "0".)

FREQ.:

8kHz, 12kHz (The factory default setting is "12kHz".)

Adjusting the non fader output volume

You can adjust the volume output from the unit's non fader output terminal.

- 2-1. Touch the [◀] or [▶] key of the NON FADER VOL item to adjust to desirable level.

Setting range:

-6 to 6 (The factory default setting is "0".)

Turning on/off the MAGNA BASS EXTEND

The Magna Bass Extend does not adjust the low sound area like the normal sound adjustment function, but emphasizes the deep bass sound area to provide you with a dynamic sound.

- 2-1. Touch the [✔] key to display the next menu screen.
- 3-1. Touch [ON] or [OFF] of the [M-B EX] item to turn the Magna Bass Extend effect on or off (The factory default setting is "OFF").

Adjusting the MONITOR

1. Press the **[ADJ]** button, then touch the **[MONITOR]** key.



2. Perform the adjustment for the desired item. See the following sections for detail.
3. Touch the **[Back]** key to return to the previous screen.
 - * In the following sections, only the details regarding adjustments are described, procedures to select items are skipped.

Changing the color of the title and command bars in the screen

- 2-1. Touch the **[▶]** key of the MONITOR ADJ item to display the Monitor Adjust screen.
 - * This screen can also be displayed directly by pressing and holding the **[ADJ]** button for more than 1 second.
- 2-2. Touch the **[Auto]**, **[Day]** or **[Night]** key to set the color mode (The factory default setting is **“Auto”**).

“Auto”:

The color is changed according to the status of the car light:
When the car light is off: light gray color
When the car light is on: dark gray color

“Day”:

Set to the light gray color.

“Night”:

Set to the dark gray color.

Note:

- The setting for the MONITOR ADJ item made in the NAVI mode automatically returns to **“Auto”** (the factory default setting) if the power is turned off or the vehicle's illumination switch is operated.

Adjusting the brightness, color, hue and dimmer level

Note:

- The Color and Hue settings can be adjusted only in the DVD video, Video CD, TV/VTR and VISUAL modes, and only when the car is stopped and the parking brake is applied.
- The Hue setting can be adjusted only when the NTSC mode is selected.

- 2-1. Touch the **[▶]** key of the MONITOR ADJ item to display the Monitor Adjust screen.
 - * This screen can also be displayed directly by pressing and holding the **[ADJ]** button for more than 1 second.
- 2-2. Touch the **[Bright]** key repeatedly to select the adjustment type. Every pressing it changes adjustment type as follows:
[Bright] → [Color] → [Hue] → [Dimmer] → [Bright] ...

“Bright”:

Adjusts the brightness of the display.

“Color”:

Adjusts the color saturation.

“Hue”:

Adjusts the tone of color (red is emphasized or green is emphasized).

“Dimmer”:

Adjusts the panel brightness when the car lights are ON/OFF.

- 2-3. Touch **[◀]** or **[▶]** key to adjust a level.

Bright/Color/Hue:

The factory default setting is medium level.

Dimmer:

The factory default setting is, when the car light is off: brightest level when the car light is on: medium level

“Bright”

[▶]: Press to make image brighter.

[◀]: Press to make image dimmer.

“Color”

[▶]: Press to increase color depth.

[◀]: Press to decrease color depth.

“Hue”

[▶]: Press to increase green.

[◀]: Press to increase red.

“Dimmer”

[▶]: Press to make image brighter.

[◀]: Press to make image dimmer.

Warning display when CCD camera is installed

The following warning message is displayed during use of the CCD camera: **“Make sure of safety around your vehicle”**.

- 2-1. Touch the **[ON]** or **[OFF]** key of the CAMERA WARNING item to turn this function on or off (The factory default setting is **“ON”**).

Switching the VTR system between NTSC and PAL

Note:

- This setting is applied only to the VISUAL/VTR input mode.
- 2-1. Touch the **[NTSC]** or **[PAL]** key of the NTSC/PAL item to set the VTR system (The factory default setting is **“NTSC”**).

Changing the color of the background picture

- 2-1. Touch the **[▶]** key of the WALL COLOR item to display the WALL COLOR screen.
- 2-2. Touch the desired Color you wish to set (The factory default setting is **“CYAN”**).

Turning on/off the motion of the background picture

- 2-1. Touch the **[ON]** or **[OFF]** key of the MOTION item to set the function (The factory default setting is **“ON”**).

Front monitor lock

When an external device is connected to the Visual terminal, lock the front monitor to show the visual input source.

Note:

- This function is enabled only when the CONNECT item of the GENERAL menu is set to other than **“NONE”**.

1. Press the **[MAP]** button to set the monitor lock.
The front monitor screen is locked to show the visual input source.
2. To cancel the monitor lock, press the **[MAP]** button.
The screen returns to show the image of the selected mode.

Adjusting the GENERAL

1. Press the **[ADJ]** button, then touch the **[GENERAL]** key.



2. Touch the **[✓]** key to display the next menu screen if desired.



3. Perform the adjustment for the desired item. See the following sections for detail.
4. Touch the **[Back]** key to return to the previous screen.

* In the following sections, only the details regarding adjustments are described, procedures to select items are skipped.

Setting the BEEP

The sound heard when you make operations is called “beep”. The unit can be set up so that it does not produce this beep sound.

- The factory default setting is **“ON”**.

- 3-1. Touch the **[ON]** or **[OFF]** key of the BEEP item to turn the function on or off.

Setting the Blink LED

When this function is set to **“ON”**, the Blink LED indicator will blink when the ACC power is turned off.

- 3-1. Touch the **[ON]** or **[OFF]** key of the BLINK LED item to turn the function on or off (The factory default setting is **“OFF”**).
 - Setting the CATS function (see page 27) turns on the Blink LED function as well.

Basic Operations

Performing the system check

- 3-1. Touch the [▶] key of the SYSTEM CHECK item.
- 3-2. Touch [Check] key at the top right of the screen to perform the system check manually.
The system will be restarted after performing the system check.

Changing the output speaker for the cellular phone

When you connect your cellular phone to this unit using a separately sold adaptor, you can listen to your telephone calls on your car speakers.

- The factory default setting is "RIGHT".
- To output the telephone calls, set the following TEL SWITCH item to "ON".

- 3-1. Touch the [LEFT] or [RIGHT] key of the TEL SP item to set to "LEFT" or "RIGHT".

LEFT:

Telephone calls are heard from the front left speaker connected to this unit.

RIGHT:

Telephone calls are heard from the front right speaker connected to this unit.

Note:

- During cellular phone interrupts, setting this function is disabled.

Cellular phone interrupt setting

- The factory default setting is "OFF".

- 3-1. Touch the [ON], [OFF] or [MUTE] key of the TEL SWITCH item to set to "ON", "OFF" or "MUTE".

ON:

You can listen to your telephone calls from the speakers connected to this unit.

- * When listening to your calls on your car speakers, you can adjust the volume using the [+]/[-] buttons.

OFF:

This unit continues normal operation even when you use the cellular phone.

MUTE:

The sound from this unit is muted during telephone calls.

Note:

- This function is not compatible with all cellular telephones. Contact your local authorized Clarion dealer for information on proper installation and compatibility.
- When you set this function to "OFF", disconnect the cellular phone from the cable or turn off the power of the cellular phone.

Setting the voice input line for the cellular phone

When you connect your cellular phone to this unit, select the connection method of the adaptor box.

- The factory default setting is "CeNET".

- 3-1. Touch the [✔] key to display the next menu screen.

- 3-2. Touch the [CeNET] or [AUX] key of the TEL SELECT item to set to "CeNET" or "AUX".

CeNET:

Selects when the adaptor box is connected via the CeNET.

AUX:

Selects when the adaptor box is connected to Audio (left/right) of the Visual input terminal.

Note:

- When setting to "AUX", the VISUAL mode is altered to the ACCESSORY mode.

Switching CONNECT (connect)

Make the following settings when an external device is connected to the Visual terminal.

NAVI:

When a navigation system is connected.

- * When the navigation system is connected, use the monitor lock function. Locking the monitor locks the screen size in F.WIDE mode (full wide) and the VTR system to NTSC.

OTHER:

For external devices other than a navigation system.

NONE:

When no external device is connected.

- The factory default setting is "NONE".

- 3-1. Touch the [✔] key to display the next menu screen.

- 3-2. Touch the [NAVI], [OTHER] or [NONE] key of the CONNECT item to set the function to "NAVI", "OTHER" or "NONE".

Adjusting the CLOCK

Note:

- This setting is disabled when the Navigation system is connected. The clock is automatically adjusted using the CT (clock time) data in the GPS data.

- Press the [ADJ] button, then touch the [CLOCK] key.



- Touch the [▲] and [▼] keys under the Hour, Minute and a.m./p.m. box to adjust the time, then touch the [SET] key (The factory default setting is "1:00 a.m.").

* The time is displayed in 12-hour format.

Setting the anti-theft function (CATS)

"CATS" is the acronym of "Clarion Anti-Theft System".

When you set a PIN code (called as "Personal Code"), a theft is prevented by disabling the operation of the unit at the theft.

In addition, set the BLINK LED function in the GENERAL menu to [ON] to improve the effect of the CATS function (see page 25).

Setting your Personal Code

- Press the [ADJ] button, then touch the [GENERAL] key.
- Keep pressing the [MENU] button more than 2 seconds. The SET PERSONAL CODE screen appears.

* When a Personal Code is already set, the ERASE PERSONAL CODE screen will appear. Retry this operation after erasing the old Personal Code.

- Enter your desired 4-digit Personal Code by touching the [0] to [9] keys, then touch the [ENT] key.

* Touch the [CLR] key when you make a mistake in entering.

Note:

- Write down your Personal Code in case you forget it.

- Enter the same Personal Code again for confirmation, then touch and hold the [ENT] key for more than 2 seconds. The entered Personal Code will be set, and it will return to the previous screen.

Erasing the Personal Code

- Press the [ADJ] button, then touch the [GENERAL] key.
- Keep pressing the [MENU] button more than 2 seconds. The ERASE PERSONAL CODE screen appears.
- Enter the Personal Code currently set by touching the [0] to [9] keys, then touch and hold the [ENT] key for more than 2 seconds. The message "CODE ERASED" appears, and it will return to the previous screen.

When the ENTER PERSONAL CODE screen appears

The ENTER PERSONAL CODE screen will be displayed when turning the ACC power on after performing the following operations:

- The car battery was replaced.
- The backup power was cut off.
- The Reset button was pressed.

Note:

- If you have lost your Personal Code, please contact Clarion customer service at 800-347-8667.

- Enter your Personal Code currently set.
- When the correct Personal Code is entered, the unit will restart from the initial startup screen.

Note:

- When you enter a wrong Personal Code, the message "CODE INCORRECT" is displayed and the Personal Code entry is prohibited for a while. This prohibited time is changed according to the number of times of wrong code entry as follows:
 - 1 to 6 times: 15 seconds
 - 7 times or more: 15 minutes

2-ZONE Function

About the 2-ZONE function

The 2-ZONE function is a function that outputs separate sounds/images from the MAIN zone and SUB zone (such as the optional rear monitor) by simultaneously operating two sources in the one center unit. Thereby, plural listeners are allowed to enjoy separate audio/visual sources. The 2-ZONE function allows internal sources (TUNER, DVD, VISUAL, iPod) and external sources via CeNET connection (CD changer, TV, Satellite Radio, etc.) to be played on MAIN zone and SUB zone.

Controlling sources of MAIN zone and SUB zone can be made from the main unit and from the remote control unit.

The source sounds of the MAIN zone are played back from the speakers of the vehicle side, and those of the SUB zone are from the headphone systems (WH104).

Sound volume control on the SUB zone is performed by the headphone system (WH104).

Note:

- The TUNER mode cannot be specified for the SUB zone.
- The 2-ZONE function is disabled when the 5.1 channel surround decoder (DVH940N) is connected.
- The steering wheel remote control operations work upon the MAIN zone even when the SUB zone is selected.
- When a voice interrupt of the navigation system arises during 2-ZONE ON, the sound of the MAIN zone is muted, and the sound of the SUB zone is output normally.
When it arises during 2-ZONE OFF, the audio signals to the 4ch speakers are attenuated, and the voice from the navigation system is output from the front two speakers.
- You cannot operate the 2-ZONE function during the voice interrupt of the navigation system.
- If a cellular phone interrupt arises when an external equipment is specified for the SUB zone, the 2-ZONE function is automatically turned off, and it does not resume to the 2-ZONE ON status even when the interruption is finished.
- You cannot switch the MAIN and SUB zone when the following screen is displayed:
 - Navigation mode screen
 - Front monitor locked screen
 - CCD camera screen

Setting the 2-ZONE function

- The factory default setting is "OFF".
 - * The function can also be switched by using the remote control unit. See the chapter "Remote Control" (page 13) for details.
1. Press the [SRC] button to display the Source menu.
 2. Touch and hold the [2 ZONE] key more than 1 second to turn the 2-ZONE function on. The 2-ZONE indication is displayed at the top left of the screen.



2-ZONE indication

Displayed when 2-ZONE function is turned on.

- [MAIN]:MAIN zone is selected.
 - [SUB]:SUB zone is selected.
3. Touch the [SUB] key on the Source menu to switch to the SUB zone. You can control the operation modes for the SUB zone.
 4. Press the [SRC] button, and touch the [MAIN] key to return to the MAIN zone.
 5. To turn the 2-ZONE function off, touch the [2 ZONE] key on the Source menu.

Monitor image and sound with 2-ZONE ON/OFF

● With 2-ZONE function OFF

	Front monitor lock ON		Front monitor lock OFF	
	Visual connection [OTHER] (*1)	Visual connection [NAVI] (*1)	Visual connection [OTHER] (*1)	Visual connection [NAVI] (*1)
Front monitor (main unit)	Displays image of device connected to the Visual terminal. (*3)	Displays image of device connected to the Visual terminal.	Displays image of mode selected from the Source menu.	
Rear monitor (optional)	Displays image of mode selected from the Source menu. (*2)			
Audio output	Sound from mode selected from the Source menu is output from 4ch speaker, NON-FADER, and AUDIO-OUT.			

● With 2-ZONE function ON

	Front monitor lock ON		Front monitor lock OFF	
	Visual connection [OTHER] (*1)	Visual connection [NAVI] (*1)	Visual connection [OTHER] (*1)	Visual connection [NAVI] (*1)
Front monitor (main unit)	Displays image of device connected to the Visual terminal. (*3)	Displays image of device connected to the Visual terminal.	Displays image of mode selected from the Source menu in the MAIN zone mode.	
Rear monitor (optional)	Displays image of mode selected from the Source menu in the SUB zone mode. (*2)			
Audio output	<ul style="list-style-type: none"> • Sound from mode selected in the MAIN zone mode is output from 4ch speaker, NON-FADER and AUDIO-OUT. • Sound from mode selected in the SUB zone mode is output from SUB-OUT. 			

*1: A device connected to the Visual terminal should be set up as described in the section “**Switching CONNECT (connect)**” (see page 26).

*2: No image is displayed on the rear monitor when a non-image mode such as CD changer mode, etc. is selected.

*3: For safety reasons, this image is not displayed when the vehicle is moving. The picture can be watched only when the vehicle is stopped and the parking brake is applied.

Note:

• The steering wheel remote control operations work upon the MAIN zone even when the SUB zone is selected.

Radio Operations

Listening to the radio

1. Press the [SRC] button, and touch the [TUNER] key.
The TUNER mode screen is displayed.



2. Press the [BAND] button or touch the [Band] key to select the radio band. Each time the button is pressed, the radio reception band changes in the following order:
FM1 → FM2 → FM3 → AM → FM1...
3. Press the [◀] or [▶] button to tune in the previous or next preset station.

Seek tuning

1. Press the [BAND] button or touch the [Band] key to select the desired band (FM or AM).
2. If "MANU" is displayed at the bottom of the display, keep pressing the [BAND] button more than 1 second.
"MANU" in the display goes off, and seek tuning is now available.
* The same operation is available by using the [Band] key.
3. Touch the [◀] or [▶] key to automatically seek a station.
 - When touching the [▶] key, the station is sought in the direction of higher frequencies.
 - When touching the [◀] key, the station is sought in the direction of lower frequencies.

Selecting stations by entering frequency

This function displays the Key Pad on the screen allowing you to tune by entering a frequency.

1. Press the [BAND] button or touch the [Band] key to select the desired band (FM or AM).
2. Touch the [Search] key to display the Key Pad screen.



3. Touch the [0] to [9] key corresponding with the frequency you desired. When you input the wrong number, touch the [CLR] key to delete the last input number.
4. Touch the [ENT] key to tune in to the entered frequency.
5. Touch the [Back] key.

Manual tuning

There are 2 ways available: Quick tuning and step tuning.

When you are in the step tuning mode, the frequency changes one step at a time. In quick tuning mode, you can quickly tune the desired frequency.

1. Press the [BAND] button or touch the [Band] key to select the desired band (FM or AM).
2. If "MANU" is not displayed at the bottom of the screen, keep pressing the [BAND] button more than 1 second.
"MANU" appears on the screen, and the manual tuning is now available.
* The same operation is available by using the [Band] key.
3. Tune into a station.

Quick tuning:
Touch and hold the [◀] or [▶] key for more than 1 second to tune in a station.

Step tuning:
Touch the [◀] or [▶] key to manually tune in a station.

Recalling a preset station

There are total of 24 preset positions (6-FM1, 6-FM2, 6-FM3, 6-AM) to store individual radio stations in memory.

There are 2 ways available to recall the preset station.

● Using the [◀◀] or [▶▶] button

1. Press the [BAND] button to select the desired band (FM or AM).
2. Press the [◀◀] or [▶▶] button to recall the previous or next stored station.

● Using the Preset List screen

1. Touch the [List] key.



2. Touch the corresponding Preset key to recall the stored station.

* You can select the desired band by touching the [Band] key.

* Touching and holding the desired Preset key for more than 2 seconds will store the current station to the preset memory.

3. Touch the [List] key to return to the previous screen.

Manual memory

1. Touch the [Band] key to select the desired band. (FM or AM)
2. Select the desired station with the seek tuning, manual tuning, or preset tuning.
3. Touch the [List] key.
4. Touch and hold one of the Preset key for more than 2 seconds to store the current station into the preset memory.

Auto store

The Auto Store is a function for storing up to 6 stations that are automatically tuned in sequentially. If 6 receivable stations cannot be received, a previously stored station remains unoverwritten at the memory position.

1. Touch the [Band] key to select the desired band. (FM or AM)
2. Touch the [List] key.
3. Touch and hold the [AS] key for more than 2 seconds.

A beep sounds and the stations with good reception are stored automatically to the preset channels.

Preset scan

The Preset Scan receives the stations stored in the preset memory in order. This function is useful when searching for the desired station in memory.

1. Touch the [List] key.
2. Touch the [PS] key to start the Preset Scan. The unit starts scanning each station for 7 seconds sequentially.
3. When the desired station is tuned in, touch the [PS] key again to continue receiving that station.

Instant station recall (ISR)

Instant station recall is a special radio preset that instantly accesses a favorite radio station at a touch of a button. The ISR function even operates with the unit in other modes.

● ISR memory

1. Select the station that you wish to store in ISR memory.
2. Keep pressing the [ISR] button more than 2 seconds to store the current station into the ISR memory.

● Recalling a station with ISR

1. In any mode, press the [ISR] button to switch to the TUNER mode and tune the selected radio station. "ISR" appears in the display. Press the [ISR] button again to return to the previous mode.

* The [ISR] button is disabled when SUB zone is selected in the 2-ZONE mode.

DVD Video Player Operations

Changing DVD System Settings

Note:

- If the Setup operation is performed in the middle of DVD video play, the disc will restart from beginning.
- The settings on the DVD SETUP menu cannot be set with the remote control unit.

Selecting the DVD SETUP menu

1. Press the [SRC] button, and touch the [DVD PLAYER] key.
The DVD PLAYER mode screen is displayed.
2. Touch the [Option] key to display the Option menu.
3. Touch the [Setup] key to display the DVD SETUP menu.



Touch the [▼] key to display the next menu.
Touch the [▲] key to return to the previous menu.



4. Perform setting for the desired setting items.
See the following sections for detail.
5. Touch the [Back] key.
 - * In the following sections, only the details regarding settings are described, the procedures to select items are skipped.

Setting up the screen size

Set up the screen size according to the rear view monitor which is connected to this unit.

- 4-1. Touch the [WIDE], [N PS] or [N LB] key of the TV DISPLAY item to change the screen size to "WIDE", "N PS" or "N LB".
 - The factory default setting is "WIDE".

● When watching through a conventional type of the rear view monitor (4:3)

N PS:

The leftmost and rightmost areas of the screen are cut off.

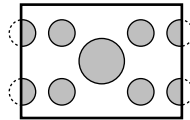

This function allows displaying the important part of image fully on the screen. In some cases, image is displayed while being panned (scrolled).

N LB:

A black zone is created in the top and bottom areas of the screen.

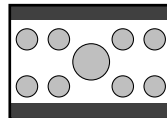

This method displays Cinema Scope and Vista Vision images without cutting them off by creating a black zone on the top and bottom gaps.

● When watching through a wide type of the rear view monitor (16:9)

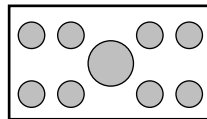

Setting up the angle mark display

You can set up so that the angle mark appears on scenes where the angles can be switched.

- 4-1. Touch the [ON] or [OFF] key of the ANGLE item to turn the Angle function "ON" or "OFF".
 - The factory default setting is "OFF".

Setting up the disc menu language

- 4-1. Touch the [▶] key of MENU LANGUAGE item.
The MENU LANGUAGE menu is displayed.
- 4-2. Touch the key to select a desired language to set it.
 - The factory default setting is “ENGLISH”.

Setting up the audio language

- 4-1. Touch the [▶] key of AUDIO LANGUAGE item.
The AUDIO LANGUAGE menu is displayed.
- 4-2. Touch the key to select a desired language to set it.
 - The factory default setting is “ENGLISH”.

Setting up the subtitle language

- 4-1. Touch the [▶] key of SUBTITLE LANGUAGE item.
The SUBTITLE LANGUAGE menu is displayed.
- 4-2. Touch the key to select a desired language to set it.
 - The factory default setting is “ENGLISH”.

Setting up the password for setting up of the parental level

- The factory default setting is “0000”.
- 4-1. Touch the [▶] key of PASSWORD item.
The PASSWORD screen is displayed.
 - 4-2. Touch the ten-key (0 to 9) to input a 4-digit password.
 - Input the old password, and touch the [ENT] key.
 - * Input “4356” to return password to “0000”.
 - Input a new password, and touch the [ENT] key.

Note:

- When a disc with view restrictions is inserted, you will be prompted to input a password. The disc will not be viewable until the correct password is entered.

Setting up the country code

Set up the country number for setting up of the parental level.

- 4-1. Touch the [▶] key of PARENTAL LOCALE item.
The PARENTAL LOCALE screen is displayed.
- 4-2. Touch the ten-key (0 to 9) to input a 4-digit country code (see the following table).
 - The factory default setting is “8583” (U.S.A).
- 4-3. Touch the [ENT] key.

● **Country code list**

Country	Input code
CANADA	6765
UNITED STATES	8583
AMERICAN SAMOA	6583
BERMUDA	6677
PUERTO RICO	8082
ST. PIERRE AND MIQUELON	8077
VIRGIN ISLANDS (U.S)	8673

Setting up the parental level

You can change the level of parental lock (audio-visual restriction).

This function allows cutting scenes that are unfavorable for children or replacing them automatically with other scenes prepared in advance. For example, by replacing scenes of radical violence or portrayals of sex with safe scenes, you can make a trouble-free story as if it were so from the beginning.

- 4-1. Touch the [◀] or [▶] key of PARENTAL LEVEL item.
When you touch the [◀] or [▶] key, PASSWORD input screen is displayed.
- 4-2. Touch the ten-key (0 to 9) to input a 4-digit password, and touch the [ENT] key.
 - The factory default setting of the password is “0000”.
- 4-3. Touch the [◀] or [▶] key to select level 1 to 8, or 0 (no parental).
 - The factory default setting is “8”.

DVD Video Player Operations

The relationship between DVD video category codes and parental level are shown in the table below. Use this table when setting the parental level.

LEVEL7	NC-17 (NO ONE 17 AND UNDER ADMITTED)
LEVEL6	R (RESTRICTED)
LEVEL4	PG-13 (PARENTS STRONGLY CAUTIONED)
LEVEL3	PG (PARENTAL GUIDANCE SUGGESTED)
LEVEL1	G (GENERAL AUDIENCES)

- The contents that the parental level restricts vary with the country code.

Basic Operations

Loading a disc

- Press the [] (OPEN/CLOSE) button to open the operation panel.
- Insert a disc into the center of the insertion slot with the label side facing up. The disc plays automatically after loading.

Note:

- Never insert foreign objects into the disc insertion slot.
- If the disc is not inserted easily, there may be another disc in the mechanism or the unit may require service.
- 8 cm (single play) discs cannot be used.

CAUTION

For your safety, the driver should not insert or eject a disc opening the operation panel while driving.

Watching/Listening to a disc already inserted

- Press the [SRC] button, and touch the [DVD PLAYER] key to select the DVD PLAYER mode.
Play starts automatically.
If no disc is loaded in the unit, "NO DISC" appears in the display.

WARNING

- Some videos may be recorded at higher than desired volume levels. Increase the volume gradually from the minimal setting after the video has started.
- For your safety, the driver should not watch the video or operate the controls while driving. Please note that watching and operating the video while driving are prohibited by law in some countries.

Note:

- For your safety, the MAX675VDII has a safety function which turns off the picture when the car is moving, so only the audio can be heard. The picture can only be watched when the car is stopped and the parking brake is applied.
- If "AUDIO ONLY" appears on the screen just after turning on the ACC power of the car, release the parking brake while confirming safety, and then engage the parking brake again.

Pausing play

- Press the [▶/||] button or touch the [▶/||] key to pause play.
"PAUSE" appears in the display.
- To resume disc play, press the [▶/||] button again.

Ejecting a disc

- Press the [] (OPEN/CLOSE) button to open the operation panel.
- Press the [▲] (EJECT) button to eject disc.
"EJECT" appears in the display. The play mode then switches to the TUNER mode.
 - * If a disc is left in the ejected position for 15 seconds, the disc is automatically reloaded (Auto reload). In this case, however, the play mode will remain set to the TUNER mode.

Note:

- If you force a disc into before auto reloading, this can damage the disc.

DVD Video Operations

Watching a DVD-Video

After disc loading, the play mode is automatically engaged.

- When playback is not started, press the [▶/||] button or touch the [▶/||] key.
- Button operation may differ depending on the story of the disc.

● About the volume adjustment when playing DVD-Video discs

This system has the independent volume data for playing DVD-Video discs. The volume setting during DVD playback does not affect the volume of the other modes, and the volume setting in the other modes does not affect the DVD playback.

● After the menu screen is displayed

For normal DVD-Video discs, the DVD menu screen appears.

After the DVD menu screen is displayed, select an item in the following operations and play it back.

Showing the DVD PLAYER mode screen

The DVD PLAYER mode screen is used to control the playback mode from the screen.

1. Touch the screen.
The DVD PLAYER mode screen is displayed. If you do not touch the screen for 7 seconds, the display will return to the playback screen.

Showing the DVD menu

1. Showing the DVD PLAYER mode screen, touch the [Menu] key during playback.
The DVD menu appears.
 - * The displayed contents may differ depending on the DVD software.
 - Example showing DVD menu display



Operating the DVD menu

You can select the button items displayed in the DVD menu by directly touching it.

If the button items are hard to select correctly, you can also operate them by displaying Key Pad on the screen.

- * When the Key Pad is displayed, direct operation of the button items is disabled.
 - * Direct operation of the button items is enabled only when the screen size is set to "WIDE" (see page 32).
1. Press the [MENU] button.
The "Cross-Key" (▲▼◀▶) is displayed.
 - Repeat pressing the [MENU] button changes the mode as follows: Cross-Key mode → Ten-Key mode → Direct operation mode → Cross-Key mode ...
 2. Select the DVD menu button items using either the "Cross-Key" or the "Ten-Key" according to the disc contents menu.
 3. Touch the [ENT] key to specify the selected button item.

Switching Key Pad position

When the Key Pad becomes difficult to view in the menu display, you can move it to the other side of the screen.

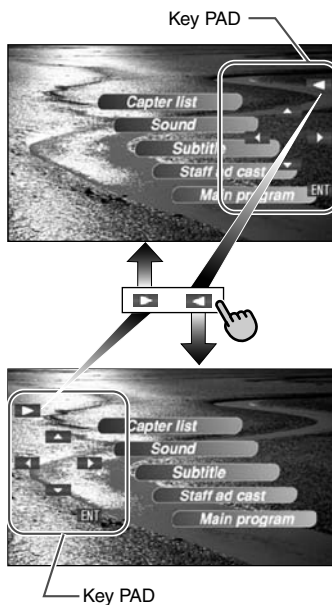

Stopping playback

1. Showing the DVD PLAYER mode screen, touch and hold the [▶/■] key for more than 1 second during playback. Playback is stopped.
2. To resume playback, press the [▶/■] button. Playback resumes from the scene where playback is stopped.

Pausing playback

1. Press the [▶/■] button or touch the [▶/■] key during playback. Playback pauses.
2. To resume playback, press the [▶/■] button again. Playback resumes.

Slow playback

1. Press the [▶/■] button or touch the [▶/■] key, then press and hold the [▶▶] button. While pressing the button, slow playback continues at the speed 1/3 times the normal playback. Releasing the button resumes the normal playback.
 - * Slow playback cannot be performed in the backward direction. In addition, audio cannot be reproduced during slow playback.

Skipping a chapter (searching)

● About chapter

Chapter means a small segment to divide the data area of the disc.

1. Press the [◀◀] or [▶▶] button during playback. Chapters are skipped, as many as the times the button is pressed, and playback starts.

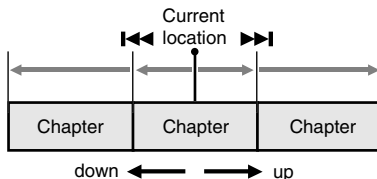

- Pressing the [▶▶] button starts playback from the beginning of the next chapter.
- Pressing the [◀◀] button starts playback from the beginning of the current chapter. When this button is pressed again within about 3 seconds, playback starts from the beginning of the previous chapter.
- The unit may return to the DVD PLAYER mode screen when the [▶▶] or [◀◀] button is pressed.

Fast forward and fast backward

1. Press and hold the [◀◀] or [▶▶] button during playback. The playback speed becomes 5-time faster in 1 second, and then 20-time faster 3 seconds later.
 - The DVD PLAYER mode screen may appear when the [◀◀] or [▶▶] button is pressed.
 - * No audio is reproduced during fast forward and fast backward operation.
 - * The fast forward and fast backward speed may differ depending on the disc.

Searching with a chapter/title number

You can locate the beginning of a scene using the chapter numbers or title numbers recorded on the DVD-Video disc.

1. Showing the DVD PLAYER mode screen, touch the **[Search]** key.
The Key Pad screen appears with the chapter number input mode. Touching the **[Title]** key turns the Key Pad to the title number input mode.
 - **Title**
A large segment to divide the data area of the disc.
 - **Chapter**
A small segment to divide the data area of the disc.
2. Input the number of the title/chapter that you want to play back with the **[0]** to **[9]** key.
3. Touch the **[ENT]** key.
Playback starts from the scene of the input title number or chapter number.
 - * If the input title/chapter number does not exist or searching with a title/chapter number is not allowed, the screen image will not change.
4. Touch the **[Back]** key.

Scan playback

Scans and plays back all chapters recorded on the DVD-Video, the first 10 seconds for each.

1. Showing the DVD PLAYER mode screen, touch the **[Option]** key.
2. Touch the **[Chapter Scan]** key, then touch the **[Back]** key.
The message "**C.SCN**" will be displayed.
 - Chapter scanning will be canceled when the last chapter is reached.
 - Chapter scanning cannot be performed if the current location is in the last chapter.
3. Press the **[|◀◀]** button to turn off the scan playback.

Repeat playback

This operation plays back chapters recorded on the DVD-Video repeatedly.

1. Showing the DVD PLAYER mode screen, touch the **[Option]** key.
2. Touch the **[Chapter Repeat]** key, then touch the **[Back]** key.
The message "**C.RPT**" will be displayed.
3. Perform the same operation to turn off the repeat playback.

TOP function

The TOP function resets the DVD player to the first chapter of the current title.

1. Press the **[BAND]** button to play back the first chapter (chapter No. 1).

Using the title menu

On DVD discs containing two or more titles, you can select from the title menu for playback.

1. Showing the DVD PLAYER mode screen, touch the **[Top Menu]** key during playback. The title menu screen appears.
 - * Depending on the disc, the title menu cannot be called.
2. Select the button items displayed in the title menu screen by the same way of the DVD menu operation.
 - * Depending on the disc, items cannot be selected with the ten-key buttons.

Switching among languages

On discs in which two or more audios or audio languages have been recorded, you can switch among the audio languages during playback.

- Showing the DVD PLAYER mode screen, touch the **[Option]** key.
- Touch the **[Audio]** key during playback.
 - Each time you touch the key, you can switch among audio languages.
 - It may take time to switch among audios.
 - * Depending on the disc, up to 8 audios may be recorded. For details, see the mark of the disc (8): Indicates that 8 audios have been recorded).
 - * When the power is turned on and when the disc is changed to a new one, the language set as the factory default is selected. If that language has not been recorded, the language specified on the disc.
 - * Depending on the disc, switching may be completely impossible or impossible on some scenes.
- Touch the **[Back]** key to return to the previous screen.

Switching subtitles

On DVD discs in which two or more subtitle languages have been recorded, you can switch among the subtitle languages during playback.

- Showing the DVD PLAYER mode screen, touch the **[Option]** key.
- Touch the **[Sub Title]** key during playback. Each time you touch the key, you can switch among subtitles.
 - It may take time to switch among subtitles.
 - * Depending on the disc, up to 32 kinds of subtitles may be recorded. For details, see the mark of the disc (8): Indicates that 8 kinds of subtitles have been recorded).
 - * Depending on the disc, switching may be completely impossible or impossible on some scenes.
- Touch the **[Back]** key to return to the previous screen.

● To turn off subtitles

- Repeat touching the **[Sub Title]** key until **"Sub Title: OFF"** is displayed on the screen. Subtitles are turned off.

Switching angles

On DVD discs in which video images have been recorded in two or more angles, you can switch among the angles during playback.

- Touch the **[Angle]** key during playback. Each time you touch the key, you can switch among angles.
 - It may take time to switch among angles.
 - * Depending on the disc, up to 9 angles may be recorded. For details, see the mark of the disc (9): Indicates multi-angle).
 - * Depending on the disc, angles may switch smoothly or switch with a momentary still image.
 - * Depending on the disc, switching may be completely impossible or impossible on some scenes.
 - * Depending on the disc, scenes recorded in two or more angles may be played back.

Displaying the playback status

- Showing the DVD PLAYER mode screen, touch the **[Option]** key.
- Touch the **[P.Time]** key during playback.
- Touch the **[Back]** key to return to the previous screen. Playback status is displayed on the screen.

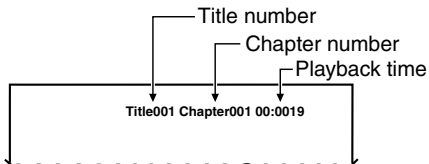

Watching a video CD

After disc loading, the play mode is automatically engaged.

- Button operation may differ depending on the story of the disc.

● After the menu screen is displayed

For Video CD discs equipped with the PBC (Play Back Control) function, the menu screen appears. After the menu screen is displayed, select an item in the following operations and play it back.

Note:

- There are two types of Video CDs, and these differ in some operations and functions. For the operations and functions of a Video CD, see the documents attached to the Video CD.

Showing the V-CD menu (for Video CD discs with PBC)

* This key does not function on some discs.

1. Touch the screen to display the VIDEO CD mode screen, then touch the [Menu] key during playback. The Video CD menu appears.
 - * The displayed contents may differ, depending on the Video CD software.
2. To operate the Video CD menu items, press the [MENU] button and use either the "Cross-Key Pad" or the "Ten-Key Pad" according to the disc contents menu.
 - * You can also operate the Video CD menu by directly touching the menu items.

Pausing playback

1. Press the [▶/⏏] button. Playback stops.
2. To resume playback, press the [▶/⏏] button again. Playback resumes from the scene where playback is paused.

Slow playback

1. Press the [▶/⏏] button then press and hold the [▶▶] button.

While pressing the button, slow playback continues at the speed 1/3 times the normal playback.

- * Slow playback cannot be performed in the backward direction. In addition, audio cannot be reproduced during slow playback.

Skipping a track (searching)

1. Press the [⏮] or [▶▶] button during playback. The track is skipped and playback starts.

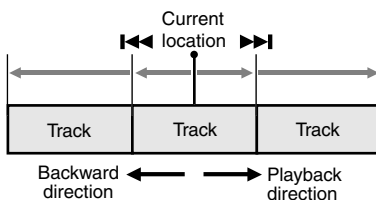

- Pressing the [▶▶] button starts playback from the beginning of the next track.
- Pressing the [⏮] button starts playback from the beginning of the current track. When this button is pressed again within about 2 seconds, playback starts from the beginning of the previous track.
- * In the case of some discs furnished with PBC function, when PBC is set to "ON", this operation will cause the menu screen to be displayed.

Fast forward and fast backward

1. Press and hold the [⏮] or [▶▶] button during playback. The playback speed becomes 5-time faster in 1 second, and then 20-time faster 3 seconds later. Releasing the button resumes the normal speed playback.
 - The unit may return to the menu screen when the button is pressed.
 - * No audio is reproduced during fast forward and fast backward operation.

DVD Video Player Operations

Searching with a track number

This operation allows searching with the track numbers recorded on the video CDs.

1. Touch the screen to display the VIDEO CD mode screen.
2. Touch the **[Search]** key.
3. Input the track number that you want to play back with **[0]** to **[9]** key.
4. Touch the **[ENT]** key.
Playback starts from the scene of the input track number.
 - If the input track number does not exist or searching with a track number is not allowed, the screen image will not change.
 - * If you are playing a disc with PBC and the PBC function is engaged, this operation may not be performed.
5. Touch the **[Back]** key.

Changing audio output

You can change the audio output method.

1. Touch the screen to display the VIDEO CD mode screen.
2. Touch the **[Audio]** key during playback.
Each time you touch the key, the audio output method is switched as follows:

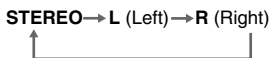

Displaying the playback status

1. Touch the screen to display the VIDEO CD mode screen.
2. Touch the **[P.Time]** key during playback.
The screen will automatically return to the playback screen in about 7 seconds, and the playback status will be displayed on the playback screen.

On/Off of Playback Control

On Video CDs equipped with Play Back Control function, you can turn it on/off.

- The factory default setting is "ON".
1. Touch the screen to display the VIDEO CD mode screen.
 2. Each time you touch the **[PBC]** key, you can switch between on and off.
When the PBC is turned on or off, the disc plays from the beginning.

● Playback control (PBC)

This control signal is recorded on a Video CD for version 2.0 and used to control playback. Using pre-recorded menu screens in the Video CD with PBC, you can enjoy playback of software with a simplified dialog function or software with search function. You can also enjoy a still picture at high or standard resolution.

Listening to a CD

This unit is a CD TEXT compatible model, and supports the display of the DISC TITLE, TRACK TITLE and ARTIST of the CD TEXT.

After disc loading, the play mode is automatically engaged.

- When playback is not started, press the **[▶/■]** button or touch the **[▶/■]** key.

Note:

- This unit supports only CD TEXT in English. Also, some character data may not be reproduced properly on the display.

Pausing playback

1. Press the **[▶/■]** button or touch the **[▶/■]** key during playback.
Playback pauses.
2. To resume playback, press the **[▶/■]** button or touch the **[▶/■]** key.
Playback resumes.

Skipping a track (searching)

1. Press the **[◀◀]** or **[▶▶]** button during playback.
Tracks are skipped, as many as the times the button is pressed, and playback starts.
 - Pressing the **[▶▶]** button starts playback from the beginning of the next track.
 - Pressing the **[◀◀]** button starts playback from the beginning of the current track.
When this button is pressed again within about 2 seconds, playback starts from the beginning of the previous track.

TOP function

The TOP function resets the DVD player to the first track of the disc.

1. Press the **[BAND]** button to play back the first track (track No. 1).

Fast forward and fast backward

1. Press and hold the **[◀◀]** or **[▶▶]** button during playback.
The playback speed becomes 5-time faster first and then 20-time faster 3 seconds later. Releasing the button resumes the normal speed playback.

Searching with a track number

This operation allows searching using the track numbers recorded on the CDs.

1. Touch the **[Search]** key.
2. Input the track number that you want to play back with **[0]** to **[9]** key.
3. Touch the **[ENT]** key.
Playback starts from the track of the input track number.
 - If the input track number does not exist or searching with a track number is not allowed, the screen image will not change.
4. Touch the **[Back]** key.

Selecting a track on the Track List screen

This function allows you to select tracks from a displayed list.

1. Touch the **[List]** key.
The Track List screen is displayed.
2. When the desired track is not displayed, touch the **[▲]** or **[▼]** key to scroll the track list.
3. Touch the desired track title key.
The corresponding track is started playback.
4. Press the **[Back]** key to return to the previous screen.

Other various play functions

1. Touch the **[Option]** key.



2. Touch the touch key of the function you want to play.
 - [Track Scan]:** track scan playback
This operation scans and plays back all tracks recorded on the disc, the first 10 seconds for each.
 - “**T.SCN**” is displayed on the screen.
 - [Track Repeat]:** track repeat playback
This operation plays back tracks recorded on the CD repeatedly.
 - “**T.RPT**” is displayed on the screen.
 - [Track Random]:** track random playback
This operation plays all tracks on the disc in no particular order.
 - “**T.RDM**” is displayed on the screen.
3. To cancel the play, touch the key of the function to cancel.
4. Touch the **[Back]** key to return to the previous screen.

Displaying CD titles

This unit can display title data for CD-text CDs.

1. Touch the **[Title]** key.
2. Touch the **[<<]** key of the Disc, Artist, or Track item to cause the respective display to scroll once.

Listening to an MP3/WMA

This unit is an ID3 Tag compatible model. This unit supports the ID3 TAGs of the Version 2.4, 2.3, 1.1 and 1.0. In displaying, this unit gives priority to the Version 2.3 and 2.4 TAGs. After disc loading, the play mode is automatically engaged.

What is MP3/WMA?

MP3 is an audio compression method and classified into audio layer 3 of MPEG standards. WMA is an audio compression method developed by Microsoft Corporation. These audio compression methods have penetrated into PC users and become a standard format.

These features compress the original audio data to about 10 percent of its initial size with a high sound quality. This means that about 10 music CDs can be recorded on a CD-R disc or CD-RW disc to allow a long listening time without having to change CDs.

Note:

- Some CDs recorded on CD-R/RW mode may not be usable.

Displaying MP3/WMA TAG titles

Tag information such as title, artist and album title can be displayed for an MP3/WMA file containing Tag information.

Precautions when creating an MP3 disc

● File extensions

1. Always add a file extension “.MP3” or “.mp3” to an MP3 file, and “.WMA” or “.wma” to a WMA file by using single byte letters. If you add a file extension other than specified or forget to add these file extension, the file cannot be played. In addition, if you use upper case and lower case letters (capital and small letters) mixedly for file extensions, normal play may not be possible.
2. Files other than MP3/WMA data cannot be played. Playing files with a format not supported will be skipped, and the scan, random and repeat playback mode may be canceled.

● Logical format (File system)

1. When writing an MP3/WMA file on a disc, please select “**ISO9660 level 1 or level 2 (without including expansion format)**” as the writing software format. Normal playback may not be possible if the disc is recorded on another format.
2. The folder name and file name can be displayed as the title during MP3/WMA play but the title must be within 31 single byte alphabetical letters and numerals for the folder name and file name (including an extension). Entering more letters or numerals than specified may cause an incorrect display.

● Folder structure

1. A disc with a folder having more than 8 hierarchical levels will conflict with the ISO9660 and playback will be impossible.

● Number of files or folders

1. The maximum allowable number of folders is 255 (including root directory); the maximum allowable number of files is 512 (max. 255 per folder). This represents the maximum number of tracks that can be played back.
2. Tracks are played in the order that they were recorded onto a disc. (Tracks might not always be played in the order displayed on the PC.)
 - Some noise may occur depending on the type of encoder software used while recording.
 - In case of a track recorded at VBR (variable bit rate), the display for the play time of the track may be slightly different from the actual play time. Also, the recommended value of VBR ranges from 32 kbps to 320 kbps.
 - Depending on the damage conditions of a file, it may occur that the file is not played and the next file is played instead. Also, if the damage is in a severe condition, play stops showing the “**ERROR 3**” display.
 - After disc selection, the play mode is automatically engaged.

Note:

- If Tag information was entered with 2-byte characters, it may occur that the characters are not reproduced properly on the display.
- MP3/WMA files that the DRM (Digital Rights Management) function is set cannot be played.

Regarding MP3/WMA folder creation

Up to 8 folder levels (including the root directory) can be created for MP3/WMA files (items 1 – in the illustration). However, on this unit, folders created above the third level will be converted to 2 levels.

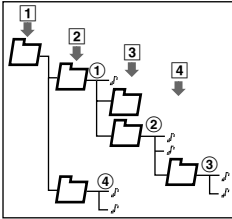

Pausing playback

1. Press the [▶/||] button or touch the [▶/||] key during playback. Playback pauses.
2. To resume playback, press the [▶/||] button or touch the [▶/||] key again. Playback resumes.

Skipping a track (searching)

1. Press the [◀◀] or [▶▶] button during playback. Tracks are skipped, as many as the times the button is pressed, and playback starts.
 - Press the [▶▶] button starts playback from the beginning of the next track.
 - Press the [◀◀] button starts playback from the beginning of the current track. When this button is pressed again within about 2 seconds, playback starts from the beginning of the previous track.

* This function performs in the current folder only.

Fast forward and fast backward

1. Press and hold the [◀◀] or [▶▶] button during playback. The playback speed becomes 5-time faster in 1 second, and then 20-time faster 3 seconds later. Releasing the button resumes the normal speed playback.

Skipping the current folder

1. Press the [BAND] button during playback. The tracks of the current folder are skipped and playback starts from the first track of the next folder.

Selecting a folder/track on the LIST screen

1. Touch the [List] key during playback. Folder List screen is displayed.
2. When the desired folder is not displayed, touch the [↵] or [⇩] key to scroll the list.
3. Touch the desired folder name key. The Track List screen appears.
4. Touch the [↵] or [⇩] key to scroll the list, and touch the desired track name key. The corresponding track is started playback.
 - Touch the [◀] or [▶] key to display the Track List of the previous or next folder.
 - Touch the [Back] key to return to the Folder List screen.
5. Touch the [Back] key.

Playback by selecting a folder and track (Direct select mode)

This operation allows searching using the folder and track numbers recorded on the MP3/WMA disc.

1. Touch the [Search] key. The Key Pad screen appears with the track number input mode. Touching the [Folder] key turns the Key Pad to the folder number input mode.
2. Input the number for the track or folder that you want to play back with [0] to [9] key.
3. Touch the [ENT] key. When you select the folder number, playback starts from track 1 of the input folder number.
4. Touch the [Back] key.

Other various play functions

1. Touch the [**Option**] key.



2. Touch the touch key of the function you want to play.

[Track Scan]: track scan playback

This operation scans and plays back all tracks recorded on the disc, the first 10 seconds for each.

- “**T.SCN**” is displayed on the screen.

[Folder Scan]: folder scan playback

This operation plays back the first tracks of all folder on the MP3/WMA disc, the first 10 seconds for each.

- “**F.SCN**” is displayed on the screen.

[Track Repeat]: track repeat playback

This operation plays back the tracks currently being played back repeatedly.

- “**T.RPT**” is displayed on the screen.

[Folder Repeat]: folder repeat playback

This operation plays back tracks in an MP3/WMA folder repeatedly.

- “**F.RPT**” is displayed on the screen.

[Track Random]: track random playback

This operation plays the tracks in the folder in a random order.

- “**T.RDM**” is displayed on the screen.

[Folder Random]: folder random playback

This operation plays back tracks recorded on the disc in no particular order.

- “**F.RDM**” is displayed on the screen.

3. To cancel the play, touch the key of the function to cancel.
4. Touch the [**Back**] key to return to the previous screen.

Displaying CD titles

1. Touch the [**Title**] key.
2. Touch the [◀◀] key of the Folder, Track, Album, Artist or Title item to cause the respective display to scroll once.

Entering titles

Titles up to 10 characters long can be stored in memory and displayed for Radio stations, CD, TV stations, and CDs in the CD changer. The numbers of titles that can be entered for each mode are as follows.

Mode	Number of titles
TUNER mode	30 titles
CD mode	50 titles
TV mode	15 titles

CD changer mode	Number of titles
CDC655Tz connected	100 titles
DCZ625 connected	100 titles

* You cannot enter titles with the unit in Seek, Preset Scan, Auto store (TUNER or TV) mode. Cancel each of those operations before entering titles.

1. Press the **[SRC]** button to select the mode you want to enter a title (TUNER, CD, CD changer or TV).
2. Select and play a CD in the CD changer or a CD track or tune in to a Radio station or a TV station for which you want to enter the title.
3. Touch the screen (TV mode only).
4. Touch the **[List]** key to display the LIST screen.
To enter a CD title, touch the **[Title]** key.
5. Touch the **[Edit]** key.
The title input mode display appears.
6. Touch keys of the characters, symbols, etc. shown in the display to input titles.

“+” : Centering

“Back Space” : Backspace

“□” : Space

“Memo” : Memory

“∨” : Scroll

- Up to 10 characters can be input.
 - To switch the character types, touch the scroll key (∨) at the left of the screen.
7. Repeat the step 6 to enter the complete title.
 8. Touch and hold the **[Memo]** key for more than 2 seconds to store the title into memory. The display returns to the original mode screen.

Title list play

You can display a list of titles, then select the CD track, disc or broadcast station to listen to from that list.

* You cannot display a title list with the unit in Seek, Preset Scan, Auto store (TUNER or TV) mode. Cancel those operation modes before displaying a title list.

1. Touch the screen (TV mode only).
2. Touch the **[List]** key to display the LIST screen.

The following titles can be changed in a title list screen.

TUNER:

A title of a station stored for the presets 1 to 6 or frequency is displayed.

CD changer:

DISC titles for discs 1 to 6 are displayed. When there is not any disc in the changer, “NO DISC” is displayed.

TV/Satellite Radio:

A title of a channel stored for the presets 1 to 6 or a channel number is displayed.

3. Touch the desired title key (1 to 6) to select. The selected broadcast station or disc is played.
4. Touch the **[Back]** key to return to the previous screen.

Other Functions

Changing over monitor display size

- The factory default setting is “[F.WIDE]”.

Note:

- This function is not available while you are driving.
- Switch to the DVD PLAYER (DVD video or video CD)/VISUAL/TV mode you see.

1. Touch the screen to display the mode menu, then touch “**Display size**” key ([F.WIDE], etc.) at the top right of the screen.

The screen changes to the SCREEN MODE menu.

* You can hide the mode menu by touching and holding the “**Display size**” key (“**■CLOSE■**”).

2. Touch the [F.WIDE], [WIDE], [CINEMA], or [NORMAL] key to select the desired monitor display size.

“**F. WIDE**”: (full wide mode)

The whole image elongates horizontally.

“**WIDE**”: (wide mode)

The image at right and left ends in a display elongates horizontally.

“**CINEMA**”: (cinema mode)

The image at both top and bottom in a display disappears.

“**NORMAL**”: (normal display)

There is a black area at both right and left ends of a display. In case of normal TV broadcasting (4:3), the image can be shown without being cut or deformed.

Note:

- When a 4:3 scale image (non-wide screen image) is displayed, part of the image may be out of view or the image may be distorted when in wide mode or full-wide mode. Please use normal mode for viewing such images with the proper aspect ratio.
- During superimposed display, it becomes a full-wide mode.

Internal amplifier cancel function

This function is used to disable the internal amplifier when an external amplifier is connected.

- The factory default setting is “**OFF**”.

1. Press the [ADJ] button.
2. Touch the [AUDIO EXT.] key.
3. Touch the [ON] or [OFF] of the AMP CANCEL item to turn the internal amplifier on or off.
4. Touch the [Back] key to return to the previous screen.

iPod Operations

This unit can be used to control a connected Apple iPod (iPod Mini, fourth generation, iPod nano, iPod with video).

Note:

- Note that iPod versions higher than those noted above may not be playable.
- The unit will not operate, or may operate improperly with unsupported versions.
- First, second and third generation iPod and iPod shuffle cannot be used.

Notes regarding use of Apple iPod

- When using an iPod, after connecting the iPod to the connector, select the iPod mode by pressing the [iPod] button, or touching the [iPod] key on the Source menu.
- After the iPod has been connected to this unit, the iPod's buttons are disabled for operation.
- When the iPod mode has been selected, a special iPod control screen is displayed different from the main screens for other modes.
- When the iPod mode has been selected, the screen image input from the VISUAL terminal is output to the rear monitor.
- The remote control unit cannot be used to perform scan, repeat or random play.
- This unit can display the Podcast titles*, Artist names, Album titles, Song titles, Genre names, Playlist titles, Composer names and Audio Book titles* registered on the iPod. When no data is present, the title display will remain blank.
- * Whether these functions are available or not depends on the iPod version.
- The iPod is used with the equalizer function turned OFF.
- Do NOT connect an iPod to the unit with a headset connected to the iPod.

• Precautions regarding battery consumption:

When the iPod's internal battery becomes depleted, the recharge warning indicator will appear in the iPod's display. In this condition, the iPod cannot be played even if attached to the MAX675VDII. Also, the MAX675VDII's recharging function cannot be used to recharge the iPod. As a result, when the iPod's battery becomes depleted, use the dedicated charger provided with it to recharge the battery.

Controlling the iPod

• Selecting the iPod mode

1. Connect the iPod to the connector.
2. Press the [iPod] button.
The iPod mode can also be selected by touching the [iPod] key on the Source menu.

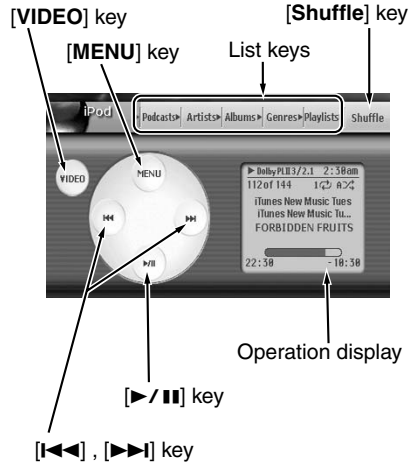

• iPod menu screen operation keys

[VIDEO] key

- * Displayed only when an iPod with video is connected.
 - Switches to the screen of which the video output from the iPod is displayed.

[MENU] key

- Displays the Option menu screen.

List keys

- Displays the corresponding list screen. [Podcasts], [Artists], [Albums], [Genres] and [Playlists] are available from the iPod menu screen. [Audio Books], [Composers] and [Songs] are only available from the Option menu screen.

[Shuffle] key

- Use to switch the shuffle mode, in the order: → Song Shuffle → Album Shuffle → Shuffle OFF.
When enabled, this function performs playback of tracks in random order, regardless of the order in which they are recorded.

iPod Operations

[▶/||] key

- Use to control playback and pause.

[◀◀], [▶▶] keys

- Use to perform track selection. Touch and hold to enable fast-forward or fast-backward.

Note:

- The title display (*) shows, from top level down, the SONG title, ARTIST name, and ALBUM title. Press the operation display to scroll the SONG title.

● Operation display

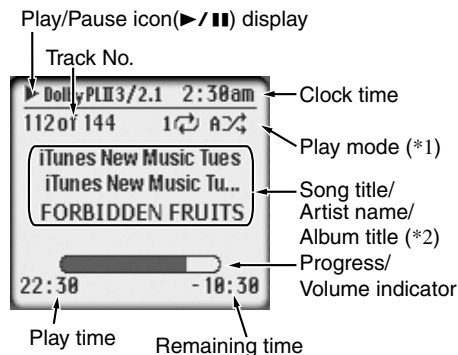

Note:

- *1 Displays status of Repeat, Shuffle play.

1 : 1-track Repeat
 A : All Repeat
 S : Song Shuffle
 A : Album Shuffle

- *2 When a Podcast or Audio Book which has two or more chapters is played back, the chapter title and chapter number are displayed.

● Option menu screen operation keys

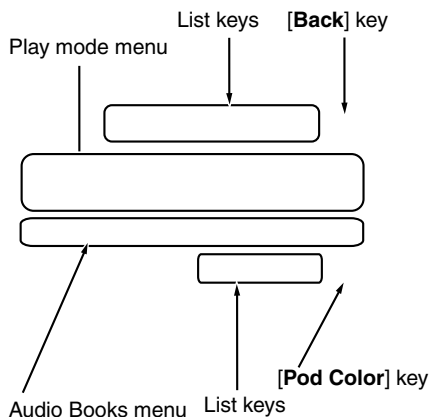

Play mode menu

- Uses to switch the shuffle mode and repeat mode.

List keys

- Displays the corresponding list screen. [Podcasts], [Artists], [Albums], [Genres], [Playlists], [Audio Books], [Composers] and [Songs] are available.

[Back] key

- Uses to return to the iPod menu screen.

Audio Books menu

- Uses to change the playback speed during playing Audio Books.

[Pod Color] key

- Changes the background color of the iPod menu screen.

Color keys: Selects the desired color.
 [AUTO]: Changed to the color of the connected iPod.

- * This function may not be applicable to some iPod models. In this case, the background color will be set to white.

Pausing playback

1. Press the [▶/||] button or touch the [▶/||] key during playback. Playback pauses.
2. To resume playback, press the [▶/||] button or touch the [▶/||] key again. Playback resumes.

Skipping a track (searching)

1. Press the [◀◀] or [▶▶] button during playback. Tracks are skipped, as many as the times the button is pressed, and playback starts.
 - Pressing the [▶▶] button starts playback from the beginning of the next track.
 - Pressing the [◀◀] button starts playback from the beginning of the current track. When this button is pressed again within about 2 seconds, playback starts from the beginning of the previous track.

- * When a Podcast or Audio Book which has two or more chapters is played back, pressing the [◀◀] or [▶▶] button during pausing moves the current location to the beginning of the previous or next chapter.

Fast forward and fast backward

1. Press and hold the [⏮] or [⏭] button during playback.
The playback speed becomes 5-time faster in 1 second, and then 20-time faster 3 seconds later.
Releasing the button resumes the normal speed playback.

TOP function

The TOP function resets the player to play the first track of the tracks.

1. Press the [BAND] button to play back the first track of the current list.
 - * To play back all of the tracks in the Songs list from the first track, keep pressing the [BAND] button more than 1 second.

Selecting a list item from a list screen

1. Touch the desired List key from the iPod menu screen or the Option menu screen to display the corresponding list screen.
2. Touch a desired list item on the screen to display the corresponding list of tracks.
 - Use the [↕] and [↔] keys to scroll the list.
 - * Skip this operation for the Podcasts, Audio Books and Songs list.
3. Touch the desired track name on the list to play back.
 - Use the [↕] and [↔] keys to scroll the list.

Viewing video data in the iPod (only for the iPod with video features)

When you connect an iPod with video features by using the optional connector cable for iPod with video, you can enjoy the video data and slideshow data stored in the iPod showing them on the display of this unit (and the rear monitor if connected).

Note:

- Do not connect the iPod to this unit when a Video Playlists item is selected on the iPod.

1. Touch the [VIDEO] key on the iPod menu screen. The screen will be changed to a black screen.

In this condition, the iPod cannot be controlled from this unit. The iPod is turned into the normal operation mode, and you can control the iPod using the original controls of the iPod (iPod operation mode).

- * In the iPod operation mode, the following buttons on this unit and its remote control unit are operative as well: [⏮], [⏭], [▶/⏪] (unit), [◀], [▶], [▶ ||] (remote control unit)
2. Play back your desired video data or slideshow data from the iPod.
The specified image data will be displayed on the display (and the rear monitor if connected).
 3. To return to the iPod menu screen, touch the [Music] key.
 - * When you touch the [Music] key during playing back image data, the playback is terminated and the first track of the first playlist will be played back.

Note:

- "AUDIO ONLY" is displayed when the automobile is moving.
- Image data may not be played back according to the status of the iPod.

VISUAL Operations

This function is available when a VTR, etc. is connected to the visual terminal.

⚠ WARNING

For your safety, the driver should not watch the VTR, etc. or operate the controls while driving. Please note that watching and operating the VTR, etc. while driving are prohibited by law in some countries.

Switching to the VISUAL mode

Note:

- For your safety, the MAX675VDII has a safety function which turns off the picture when the car is moving, so only the audio can be heard. The picture can only be watched when the car is stopped and the parking brake is applied.
- When the TEL SELECT item of the GENERAL menu (within the ADJUST menu) is set to "AUX", the VISUAL mode is altered to the ACCESSORY mode.
- The image is not displayed in the ACCESSORY mode.

CD Changer Operations

Note:

- When an optional CD changer is connected through the CeNET cable, this unit controls all CD changer functions. This unit can control up to 2 changers.

CD changer functions

Press the [SRC] button and touch the [CD A/C] key to change to the CD changer mode. Playback automatically starts.

- * If 2 CD changers are connected, the [CD A/C1] and [CD A/C2] keys will display in the Source menu.
- * If "NO MAGAZINE" appears in the display, insert the magazine into the CD changer. "DISC CHECKING" appears in the display while the player loads (checks) the magazine.
- * If "NO DISC" appears in the display, eject the magazine and insert discs into each slot. Then, reinsert the magazine back into the CD changer.

Pausing play

1. Press the [▶/■] button or touch the [▶/■] key during playback. Playback pauses and "PAUSE" appears in the screen.
2. To resume playback, press the [▶/■] button or touch the [▶/■] key. Playback resumes.

1. Press the [SRC] button, and touch the [VISUAL] key.

Changing the audio input level

The visual terminal can be used to change the input audio level.

- The factory default setting is "HIGH".
1. Touch the screen to display the menu, then repeat touching the [SENS] key to select the level.
 - HIGH:** 16.25 dB
 - MID:** 3.75 dB
 - LOW:** 0 dB

Displaying the CD TEXT titles

This operation is only possible when this unit is connected with a CD TEXT compatible CD changer.

1. Touch the [Title] key.
2. Touch the [◀◀] key of the Disc, Artist, or Track item to cause the respective display to scroll once.

Selecting a CD and track from the list

1. Touch the [List] key.
2. Touch the corresponding Disc key (1 to 6) to select the desired disc. The Track List screen appears.
 - * When touching and holding a Disc key for more than 1 second, the title will scroll.
3. When the desired track is not displayed, touch the [↵] or [↶] key to scroll the track list.
4. Touch the desired Track key. The corresponding track is started playback.
 - * When touching and holding a Track key for more than 1 second, the title will scroll.
5. Touch the [Back] key to return to the Disc List screen. Touch the [Back] key again to return to the CD changer mode screen.

Switching to a next disc (Disc Up function)

The disc up function plays from the first track (track No.1) of the next disc.

1. Press the **[BAND]** button.
The disc changes to the next disc.

Searching with a track number

* This function is available only for the current disc.

1. Touch the **[Search]** key.
2. Input the track number that you want to play back with **[0]** to **[9]** key.
3. Touch the **[ENT]** key.
Playback starts from the track of the input track number.
 - * If the input track number does not exist or searching with a track number is not allowed, the screen image will not change.
4. Touch the **[Back]** key.

Skipping a track (searching)

* This function is available only for the current disc.

1. Press the **[◀▶]** or **[▶▶]** button during playback.
Tracks are skipped, as many as the times the button is pressed, and playback starts.
 - Pressing the **[▶▶]** button starts playback from the beginning of the next track.
 - Pressing the **[◀▶]** button starts playback from the beginning of the current track.
When this button is pressed again within about 2 seconds, playback starts from the beginning of the previous track.

Fast forward and fast backward

1. Press and hold the **[◀▶]** or **[▶▶]** button during playback.
The playback speed becomes 5-time faster in 1 second, and then 20-time faster 3 seconds later.
Releasing the button resumes the normal speed playback.

Other various play functions

1. Touch the **[Option]** key.



2. Touch the touch key of the function you want to play.
 - [Track Scan]:** (track scan playback)
This scan play locates and plays the first 10 seconds of each track on a disc automatically.
 - [Disc Scan]:** (disc scan playback)
This scan play locates and plays the first 10 seconds of the first track on each disc in the currently selected CD changer.
 - [Track Repeat]:** (track repeat playback)
The repeat play continuously plays the current track.
 - [Disc Repeat]:** (disc repeat playback)
After all tracks in the current disc have been played, the disc repeat play automatically replays the current disc over from the first track.
 - [Track Random]:** (track random playback)
The random play selects and plays individual tracks on the disc in no particular order.
 - [Disc Random]:** (disc random playback)
The disc random play selects and plays individual tracks or discs automatically in no particular order.
3. To cancel the play, touch the key of the function to cancel.
4. Touch the **[Back]** key to return to the previous screen.

TV Operations

TV functions

To watch TV, requires a TV tuner. When an optional TV tuner is connected through the CeNET cable, this unit controls all TV tuner functions.

WARNING

For your safety, the driver should not watch the TV or operate the controls while driving. Please note that watching and operating the TV while driving are prohibited by law in some countries.

Watching TV

Note:

- For your safety, the MAX675VDII has a safety function which turns off the picture when the car is moving, so only the audio can be heard. The picture can only be watched when the car is stopped and the parking brake is applied.
- If "AUDIO ONLY" appears on the screen just after turning on the ACC power of the car, release the parking brake while confirming safety, and then engage the parking brake again.

1. Press the [SRC] button, and touch the [TELEVISION] key.
2. Press the [BAND] button or touch the [Band] key to select the desired TV band (TV1 or TV2).
Every pressing the button toggles the TV band between TV1 and TV2.
3. Press the [◀◀] or [▶▶] button to tune in the previous or next preset TV station.

Watching a video

The TV tuner has a VTR input terminal to which 1 external device can be connected. Connect a 12V video cassette player (VCP) or video cassette recorder (VCR) to the TV tuner input terminal.

1. Touch the screen to display the TV/VTR mode menu, then touch the [Option] key.
2. Touch the [VTR] key to change to the VTR mode.
 - To return to the TV broadcast, perform the same operation again.

Seek tuning

1. Press the [BAND] button or touch the [Band] key to select the desired TV band (TV1 or TV2).
 - * If "MANU" is displayed in the display, press and hold the [BAND] button for more than 1 second. "MANU" in the display goes off.
2. Touch the [◀◀] or [▶▶] key to automatically seek a station.
 - Touching the [▶▶] key to tune up the channel to the next available TV station, and the [◀◀] key to tune down.

Selecting with a channel number

1. Touch the screen to display the TV/VTR mode menu, then touch the [Search] key.
2. Enter the channel number corresponding with the station you desired by touching the [0] to [9] key.
 - If you touch the wrong number ([0] to [9] key), you can delete it to touch the [CLR] key.
3. Touch [ENT] key. The TV station you required would be tuned.
4. Touch the [Back] key.

Manual tuning

There are 2 ways available: Quick tuning and step tuning. When you are in the step tuning mode, the channel changes one step at a time. In quick tuning mode, you can quickly tune the desired frequency.

1. Press the [BAND] button or touch the [Band] key to select the desired band. (TV1 or TV2)
 - * If "MANU" is not displayed in the display, keep pressing the [BAND] button more than 1 second. "MANU" appears and manual tuning is now available.
2. Tune into a station.

Quick tuning:
Touch and hold the [◀◀] or [▶▶] key for more than 1 second to tune in a station.

Step tuning:
Touch the [◀◀] or [▶▶] key to manually tune in a station.

Recalling a preset station

A total of 12 TV stations can be stored (6-TV1 and 6-TV2).

There are 2 ways available to recall the preset station.

● Using the [◀◀] or [▶▶] button

1. Press the [BAND] button or touch the [Band] key to select the desired TV band. (TV1 or TV2)
2. Press the [◀◀] or [▶▶] button to recall a stored TV station.

● Using the Preset List screen

1. Touch the screen to display the menu, then touch the [List] key.
2. Touch the corresponding Preset key to recall the stored station.
 - * You can select the desired band by touching the [Band] key.
 - * Touching and holding the desired Preset key for more than 2 seconds will store the current station into the preset memory.
3. Touch the [List] key again to return to the previous screen.

Manual memory

1. Touch the [Band] key to select the desired TV band. (TV1 or TV2)
2. Tune in the desired TV station to be stored.
3. Touch the [List] key.
4. Touch and hold one of the Preset key for more than 2 seconds to store the current station into the preset memory.

Auto store

Auto store selects 6 TV stations automatically and stores each one into a preset memory. If 6 stations cannot be received with good reception, previously stored station remain and only the strong stations are stored into memory.

1. Touch the [Band] key to select the desired TV band. (TV1 or TV2)
2. Touch the [List] key.
3. Touch and hold the [AS] key for more than 2 seconds.

A beep sounds and the stations with good reception are stored automatically to the preset channels.

Preset scan

Preset scan shows each preset channel before it automatically advances to the next preset. This function is useful for searching for desired TV station in memory.

1. Touch the screen to display the TV/VTR mode menu, then touch the [List] key.
2. Touch the [PS] key to start preset scan. The unit starts scanning each station for 7 seconds sequentially.
3. When the desired channel is received, touch the [PS] key again.

Setting the TV diver

You can change the reception setting for the TV antenna connected to the TV tuner.

* Normally use the TV diver with the "ON" position.

1. Touch the screen to display the TV/VTR mode menu, then touch the [Option] key.
2. Touch the [ON] or [OFF] key of the TV DIVER item to turn this function on and off.
 - [ON]: Sets reception emphasizing the visual.
 - [OFF]: Sets the diver setting to OFF.
3. Touch the [Back] key to return to the previous mode.

Satellite Radio Operations

This function is available when a Satellite Radio Receiver is connected through the CeNET cable. This unit can control the following satellite radio receivers:

- XM Satellite Radio Receiver: XMD1000
- XM Smart Digital Adapter: XM SDA
- SIRIUS Satellite Radio Receiver: SIRCL2, SIRCL3

Note:

When the function is differ depending to the connected receiver, they are distinguished by the following notations:

“XM”: for an XM Satellite Radio Receiver

“SIRIUS”: for a SIRIUS Satellite Radio Receiver

Selecting a Satellite Radio mode

1. Press the [SRC] button, and touch the [SIRIUS] or [XM] key.
The system changes to the specified Satellite Radio mode.

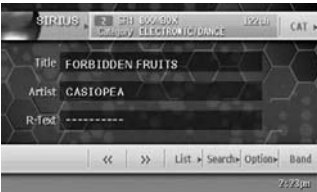

Selecting a band

1. Press the [BAND] button or touch the [Band] key to select a band.

This changes the reception band as follows:

- XM: XM1 → XM2 → XM3 → XM1 ...
- SIRIUS: SR1 → SR2 → SR3 → SR1 ...

Information displayed during reception

The following information is displayed when the satellite radio cannot be received normally.

- When the receiver is turned on the first time or after a reset: “**UPDATING**”
- When a channel is being tuned in (no signal is yet received):
XM; “**LOADING**”, SIRIUS; “**ACQUIRING**”
- A channel without a broadcast has been selected:
XM; “**--- CH**”, SIRIUS; “**INVALID CHANNEL**”
- A channel not covered by your contract:
XM; “**UPDATING**”, SIRIUS; “**CALL 888**” ↔
“**539 SIRI**” (alternated)
- When a channel is out of air time: “**OFF AIR**”

Confirming your Radio ID

● XM

1. Touch the [Search] key to display the Key Pad screen.
2. Touch the [0] key, then touch the [ENT] key. Your Radio ID (8-digits number) will be displayed.
3. To return to the previous screen, touch the [Back] key.

● SIRIUS

1. Touch the [Option] key to display the Option screen. Your SIRIUS ID (12-digits number) will be displayed.
2. To return to the previous screen, touch the [Back] key.

Displaying channel labels

1. Touch the [Title] key.
Category, CH.Name, Title, Artist and R-Text are displayed.
2. Touch the [◀◀] key of desired item.
The label of specified item will scroll once.

Displaying radio text

* Radio text is only displayed for stations that transmit such information.

Received radio text is displayed in the Main menu and the Title screen labeled as “**R-Text**”. You can scroll the radio text in the Title screen.

1. Touch the [Title] key.
2. Touch the [◀◀] key of the “R-Text” item.
The received radio text will scroll once.

Channel selection

Channels are selected with the [◀◀] or [▶▶] button.

* For details, see the following operation descriptions.

Note:

- The audio output is muted and other button operations are not accepted during channel selection.

Selecting a station with the channel number

1. Touch the **[Search]** key.
2. Enter the channel number of your desired station by touching the **[0]** to **[9]** keys.
If you enter a wrong number, you can cancel it by touching the **[CLR]** key.
3. Touch the **[ENT]** key.
The radio channel you entered will be tuned.
4. Touch the **[Back]** key.

Tuning mode (T-MODE)

There are two channel selection modes: seek mode and manual mode.

● Seek tuning

Only channels that can be received are selected. Channels without broadcasts and channels not covered by the contract will be skipped.

1. Touch the **[<<]** or **[>>]** key.
The receiver seeks the next available channel below or above the current channel.
2. Touch and hold the **[<<]** or **[>>]** key.
The receiver continues to seek channels below or above the current channel while touching the key. When the key is released, the receiver receives the next available channel.

● Manual tuning

Any channel including channels without broadcasts or channels not covered by the contract can be selected during manual tuning.

1. Keep pressing the **[BAND]** button or the **[Band]** key more than 1 second.
The seek mode is changed to the manual tuning mode, and the "MANU" indicator is displayed on the screen.
* The receiver automatically reverts to the seek tuning mode when the **[<<]** or **[>>]** key is not used for 7 seconds in the manual tuning mode.
2. Touch the **[<<]** or **[>>]** key.
The receiver moves to channels above or below the current channel one by one.
3. Touch and hold the **[<<]** or **[>>]** key for more than 1 second.
The receiver continues to seek channels below or above the current channel while touching the key. When the key is released, the receiver receives the channel received at that time.

Recalling a preset station

A total of 18 satellite radio stations can be stored (6-XM1, 6-XM2 and 6-XM3 for XM; or 6-SR1, 6-SR2 and 6-SR3 for SIRIUS). This allows you to store your favorite satellite radio stations in memory for later recall.

1. Touch the **[List]** key.
2. Press the **[BAND]** button or touch the **[Band]** key to select the desired band.
3. Touch the corresponding Preset key (1 to 6) to recall the desired preset station.
* Touching and holding the desired Preset key for more than 2 seconds stores the current station into preset memory.
4. Touch the **[Back]** key to return to the previous screen.

Receiving stations selected by category

Satellite Radio allows you to select broadcast channel category (contents).

1. Touch the **[CAT]** key.

● Selecting from preset categories

- 1-1. Touch the **[List]** key to display the Preset Category screen.
- 1-2. Select a category by touching a Category Preset key (1 to 6) that the desired category is stored.

● Selecting by displaying all categories

- 1-1. Touch the **[⤴]** or **[⤵]** key to scroll the category list.
- 1-2. Touch the desired Category item key to select the category.
2. Touch the **[<<]** or **[>>]** key to tune in a station.
This starts seek tuning and channels that meet the specified category are selected.

Note:

- When the category selection mode is entered, the category of the last received channel is displayed first.
- The category selection mode is canceled when no channel with the selected category can be found.
- The **[<<]** and **[>>]** keys are not touched within 7 seconds, the category selection mode is canceled, and resumes to the normal seek mode.

Presetting a category

A category can be preset by registering specific categories in Category Preset keys 1 to 6. Then the desired category can be recalled by pressing the corresponding Category Preset keys.

1. Touch the **[CAT]** key.
2. Touch the **[↗]** or **[↘]** key to scroll the category list.
3. Touch the Category item key you wish to store in memory.
4. Touch the **[List]** key to display the Preset Category screen.
5. Touch and hold the desired Category Preset key for more than 2 seconds to store the currently selected category to that Category Preset key.

Note:

- *When the name of a channel stored in memory is changed by a broadcast station, the display may show a channel name that differs from the stored name.*
- *A channel stored in memory may be discontinued at the option of the broadcast station.*

Scan function

There are two scan modes: the category scan mode and the preset scan mode.

During scanning channels are displayed in abbreviated form, the display mode cannot be switched.

● Category scanning

In a category scan, broadcast channels in the same category as the current channel are selected about every 10 seconds.

1. Touch the **[List]** key.
2. Touch the **[PS]** key.
 - * The category scanning can also be performed by touching the **[CS]** key in the Preset Category screen.

Note:

- *Category scanning is not available when no category is defined for the current channel.*

● Preset scan

A preset scan scans the channels (up to 18 channels) stored in the preset memory about every 10 seconds.

1. Touch the **[List]** key.
2. Touch and hold the **[PS]** key for more than 1 second.

NAVI functions

Note:

- Hereafter in this section, the Navigation system will be called as "NAVI".
- When the Clarion NAVI NAX970HD is connected, the following functions are available:
 - Showing the NAVI display
 - Operation by using the panel side buttons
 - NAVI guidance voice interruption
- When a voice interrupt of the NAVI arises during 2-ZONE ON, the sound of the MAIN zone is muted, and the sound of the SUB zone is output normally. When it arises during 2-ZONE OFF, the audio signals to the 4ch speakers are attenuated, and the voice from the navigation system is output from the front two speakers.
- Since the Clarion NAVI (NAX970HD) is automatically recognized, you can omit the below-mentioned CONNECT setting.

Setting NAVI as external input equipment

Perform this setting after connecting NAVI.

- The factory default setting is "NONE".
1. Press the [ADJ] button, and touch the [GENERAL] key.
 2. Touch the [V] key to display the next menu screen, and touch the [NAVI], [OTHER] or [NONE] key of the CONNECT item to set the function.
 - NAVI:**
Select when a NAVI is connected.
Control of it can be made only from the remote control unit.
 - OTHER:**
Select for external devices other than a NAVI.
 - NONE:**
Select when no external device is connected.

NAVI operation

Changes between the NAVI display and the Audio/Visual (hereinafter, referred as "AV") display.

Note:

- The below-mentioned [NAVI] and [AV] keys are available only when the Clarion NAVI (NAX970HD) is connected.
When the other NAVI is connected, use the [MAP] button to switch the screen mode.

● AV screen



[MAP] key

When the image interruption from the NAVI arises, the screen will be changed from the AV screen to the NAVI screen. When the interruption is finished, the screen will return to the previous AV screen.

● NAVI screen



[AV] key

Audio operations made in the NAVI mode will be indicated for about 2 seconds at the bottom of the NAVI screen.

● Operations using the buttons

[MAP] button

- The MAP screen of the NAVI mode is displayed.
- When in the AV mode, it is changed to the NAVI mode.

[MENU] button

- When in the NAVI mode, the MENU screen of the NAVI mode is displayed.

Connecting Other Company's Image Equipment

The composite type images from the other company's equipment can be displayed on this unit.

Be sure to perform this setting after connecting the composite type image equipment to the Visual terminal.

1. Press the **[ADJ]** button, and touch the **[GENERAL]** key.
2. Touch the **[✔]** key to display the next menu screen.
3. Touch the **[OTHER]** key of the CONNECT item to set the function.

Changing display

It is possible to change between the AV display and the external equipment display using the **[MAP]** button.

1. To switch from the AV screen to the NAVI screen, press the **[MAP]** button.
2. To return to the AV screen, press the **[MAP]** button again.

5.1 ch Surround Decoder Operations

This function is available when an optional 5.1 ch Surround Decoder (DVH940N) is connected. When the 5.1 ch Surround Decoder is connected through the CeNET cable, the 5.1 ch Surround Decoder Control unit (DVC920, optional) cannot be used.

5.1 ch Surround Decoder control function

This section describes operation procedures of setting functions.

For details on each function, refer to the owner's manual supplied with the 5.1 ch Surround Decoder.

* Requires an optional amplifier.

Note:

- The 2-ZONE mode is disabled when the DVH940N is connected.

1. Press the **[ADJ]** button to display the ADJUST menu.

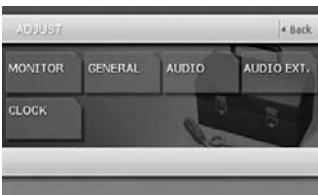

2. Touch the **[AUDIO EXT.]** key.



3. Perform setting for the desired item. See the following sections for details.
4. Touch the **[Back]** key to return to the previous screen.

* In the following sections, only the details regarding settings are described, procedures to select setting items are skipped.

●SPEAKER SEL (speaker selection)

This function determines center speaker, surround speaker and subwoofer connection.

- 3-1. Touch the **[▶]** key of the SPEAKER SEL item to show the submenu.
- 3-2. Touch the **[ON]** or **[OFF]** key of the CENTER SP, SURROUND SP or SUBWOOFER item to turn speakers on or off, depending on what speakers are connected.
 - The factory default setting is **"ON"**.
 - The phase of the **"SUBWOOFER"** is reversed in the **"ON-**" setting. The default value is **"ON+**".

●Dolby PLII CONTROL

* This function is available only when the MUSIC MODE is selected for Dolby PLII. For setup details, see **"Selecting the Dolby PLII (Dolby Pro Logic II) type"** (page 62).

- 3-1. Touch the **[▶]** key of the Dolby PLII CONTROL item to show the submenu.
- 3-2. Perform setting for the PANORAMA, DIMENSION or CENTER WIDTH item.

[PANORAMA]:

Touch the **[ON]** or **[OFF]** key to select. **"OFF"** is the default value.

[DIMENSION]:

Touch the **[◀]** or **[▶]** key to adjust the level between 0 and 6. The default level is **"3"**.

[CENTER WIDTH]:

Touch the **[◀]** or **[▶]** key to adjust the level between 0 and 7. The default level is **"3"**.

5.1 ch Surround Decoder Operations

● FILTER

This function is used to select filter frequencies that suit the speakers that are used.

* This function is not available for speakers whose SPEAKER SEL setting is set to "OFF".

- 3-1. Touch the [▶] key of the FILTER item to show the submenu.
- 3-2. Touch the [◀] or [▶] key of the FRONT HPF, CENTER HPF, SURROUND HPF or SUBWOOFER LPF item to adjust.

[FRONT HPF]:

This function can be set to the following four settings: 50 Hz, 80 Hz, 120 Hz or THRGH (through). "THRGH" is the default value.

[CENTER HPF]:

This function can be set to the following three settings: 50 Hz, 80 Hz and 120 Hz. "120 Hz" is the default value.

[SURROUND HPF]:

This function can be set to the following four settings: 50 Hz, 80 Hz, 120 Hz or THRGH (through). "THRGH" is the default value.

[SUBWOOFER LPF]:

This function can be set to the following three settings: 50 Hz, 80 Hz and 120 Hz. "120 Hz" is the default value.

● SPEAKER GAIN

This function sets speaker output level.

* This function is not available for speakers whose SPEAKER SEL setting is set to "OFF".

- 3-1. Touch the [▶] key of the SPEAKER GAIN item to show the submenu.
- 3-2. Touch the [◀] or [▶] key of the FRONT L, CENTER, FRONT R, SURROUND R, SURROUND L or SUBWOOFER item to adjust.
Each item is adjustable in the range -10 dB to +10 dB in 1 dB step increments. The default value is "0 dB".

● DELAY

This function adjusts the timing of the speakers so that they are synchronized with front speaker output.

* This function is not available for speakers whose SPEAKER SEL setting is set to "OFF".

- 3-1. Touch the [▶] key of the DELAY item to show the submenu.
- 3-2. Touch the [◀] or [▶] key of the CENTER SP or SURROUND SP item to adjust.

[CENTER SP]:

Adjustments are made in the range from 0 ms to 5 ms. The default value is "0 ms".

[SURROUND SP]:

Adjustments are made in the range from 0 ms to 15 ms. The default value is "0 ms".

● DRC

This function sets the dynamic range compression.

- 3-1. Touch the [✔] key to display the next menu screen.
- 3-2. Touch the [MAX], [STD] or [MIN] key of the DRC item to select respective item. The default value is "MAX".

DSF mode

DSF effect ON/OFF

- The factory default setting is "OFF".
1. Press the [ADJ] button, and touch the [AUDIO] key.



2. Touch the [▶] key of the STATUS item.
3. Touch the [ON] or [OFF] key of the DSF item to turn the function ON or OFF.
4. Touch the [Back] key to return to the previous screen.

Note:

- If the DSF effect is set to OFF, the adjustment made in "DSF" is not reflected in the music source.

Selecting the DSF type

1. Press the [ADJ] button, and touch the [AUDIO] key.
2. Touch the [▶] key of the DSF item.
3. Touch the key for the desirable type to select.
4. Touch the [Back] key to return to the previous screen.

P.EQ mode

P.EQ effect ON/OFF

- The factory default setting is "OFF".
1. Press the [ADJ] button, and touch the [AUDIO] key.
 2. Touch the [▶] key of the STATUS item.
 3. Touch the [ON] or [OFF] key of the P.EQ item to turn the function ON or OFF.
 4. Touch the [Back] key to return to the previous screen.

Note:

- If the P.EQ effect is set to OFF, the adjustment made in "P.EQ" is not reflected in the music source.

Setting and storing P.EQ Properties

1. Press the [ADJ] button, and touch the [AUDIO] key.
2. Touch the [▶] key of the P.EQ item to display the submenu.
3. Touch the key for the desirable type to select. The P.EQ adjustment contents are as follows:
 - [SIGNAL]:** This function selects "MUSIC" or "P.NOISE".
 - The factory default setting is "P.NOISE".
 - [SPEAKER SELECT]:** This function selects "FRONT", "CENTER" or "SURROUND".
 - The factory default setting is "FRONT".
 - * This setting is disabled when both the CENTER SP and SURROUND SP items of the SPEAKER SEL setting are set to "OFF".
 - * This function is not available for speakers whose SPEAKER SEL setting is set to "OFF".

[BAND]:

Select the channel to be compensated ("BAND1", "BAND2", "BAND3").

- The factory default setting is "BAND1".

[FREQUENCY]:

Select the center frequency that you want to compensate from the range of 18 Hz to 20 kHz. (1/3 octave step, 31 points)

- The factory default setting is "1 kHz".

[Q]:

Set the sharpness of the Q-curve to one of the parameters: 1, 3, 5, 7 and 20.

- The factory default setting is "1".

[GAIN]:

Adjust the gain (output level) in the range of -6 dB to +6 dB. (1 dB step, 13 points)

- The factory default setting is "0".

4. Touch the [Back] key to return to the previous screen.

5.1 ch Surround Decoder Operations

Selecting the Dolby PLII (Dolby Pro Logic II) type

- The factory default setting is "OFF".
 - * This setting is disabled when both the CENTER SP and SURROUND SP items of the SPEAKER SEL setting are set to "OFF".
1. Press the [ADJ] button, and touch the [AUDIO] key.
 2. Touch the [▶] key of the Dolby PLII item.
 3. Touch the key for the desirable type to select.
 4. Touch the [Back] key to return to the previous screen.

Output adjustment of subwoofer volume, center volume and balance/fader

1. Press the [ADJ] button, and touch the [AUDIO] key.
2. Touch the [▶] key of the DETAIL item to display the submenu.
3. Perform the following adjustments:

● Subwoofer volume adjustment

- 3-1. Touch the [◀] or [▶] key of the SUBWOOFER VOL item to adjust to desirable level (Setting range: -6 to 3).
 - The factory default setting is "0".

● Center volume adjustment

- 3-1. Touch the [◀] or [▶] key of the CENTER VOL item to adjust to desirable level (Setting range: -6 to 0).
 - The factory default is "0".

● Balance/Fader adjustment

- 3-1. Touch the [▶] key of the BAL/FAD item. Touch the [▲] or [▼] key to adjust the fader level.
 - [▲] key:
Emphasizes the sound from the front speakers.
 - [▼] key:
Emphasizes the sound from the rear speakers.
- 3-2. Touch the [◀] or [▶] key to adjust the balance level.
 - [◀] key:
Emphasizes the sound from the left speakers.
 - [▶] key:
Emphasizes the sound from the right speakers.
4. Touch the [Back] key to return to the previous screen.

8. TROUBLESHOOTING

GENERAL

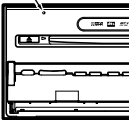
Problem	Cause	Measure
Power does not turn on. (No sound is produced.)	Fuse is blown.	Replace with a fuse of the same amperage. If the fuse blows again, consult your store of purchase.
	Incorrect wiring.	Consult your store of purchase.
Nothing happens when buttons are pressed. Display is not accurate.	The microprocessor has malfunctioned due to noise, etc.	Turn off the power and open the operation panel. Press the reset button with a thin rod. Note: When the Reset button is pressed, turn off the ACC power. <div style="text-align: center;">  </div> <p>* When the Reset button is pressed, frequencies of radio stations, titles, etc. stored in memory are cleared.</p>
The remote control unit does not work.	Direct rays of the sun fall on the light-receptive part of the remote control unit.	When direct rays of the sun fall on the light-receptive part of the remote control unit, it may not work.
	The batteries of the remote control unit are dead or there is no battery in the remote control unit.	Check the batteries of the remote control unit.

DVD Player

Problem	Cause	Measure
Disc cannot be loaded.	Another disc is already loaded.	Eject the disc before loading the new one.
	There is a foreign matter already in place.	Eject the foreign matter forcibly.
Sound skips or is noisy.	Compact disc is dirty.	Clean the compact disc with a soft cloth.
	Compact disc is heavily scratched or warped.	Replace with a compact disc with no scratches.
Sound is bad directly after power is turned on.	Water droplets may form on the internal lens when the car is parked in a humid place.	Let dry for about 1 hour with the power on.
The image is not displayed.	The parking brake is not engaged.	Check that the parking brake is engaged.
Disc cannot play with the display "PARENTAL VIOLATION" shown.	The view is limited.	Release the view limitation or change the parental level. See the subsection "Setting up the parental level" (page 33).

TV/VTR (When connecting an optional TV tuner, etc.)

Problem	Cause	Measure
The image is not displayed.	The parking brake is not engaged.	Check that the parking brake is engaged.
The display is dark.	The brightness control is too low.	Adjust the brightness properly.
	The operating condition is not good.	The temperature inside the vehicle may be 0°C or lower. Set to an appropriate temperature (25°C or so) and check it again.
	The headlight of the vehicle is lit.	The display is made dark at night to prevent the glare (When the headlight of the vehicle is lit in the daytime, the display gets dark).
The color of the display is light or a shade of color is not good.	The color is not adjusted adequately.	Check that Color and Hue are adjusted properly.
When the VTR is connected, the image is disturbed.	Improper NTSC/PAL setting	Set the NTSC/PAL properly according to the VTR.
When the TV tuner is connected, the image gets unclear.	Bad receiving condition	A radio wave may not reach sufficiently due to obstruction of mountains or buildings. Check it again at a place where a radio wave can be received properly.
The TV tuner has a double or triple image.	Bad receiving condition	It may be under the influence of radio wave reflected by mountains or buildings. Check it again after changing place or direction.
The TV tuner has spots or stripes in the image.	Presence of jamming	It may be under the influence from automobiles, streetcar, power cable, neon sign, and so forth. Check it again after changing place.
There are red, green, and blue points in the display.	_____	This is not a failure, but a phenomenon peculiar to a liquid crystal panel (The liquid crystal panel is produced according to technology with very high precision. Note that, though there are effective pixels of 99.99% or more, pixel missing or normally lit pixels account for 0.01%).

9. ERROR DISPLAYS

If an error occurs, one of the following displays is displayed.
Take the measures described below to solve the problem.

DVD Player

Display	Cause	Measure
ERROR 2	A disc is caught inside the CD deck and is not ejected.	This is a failure of DVD deck's mechanism and consult your store of purchase.
ERROR 3	A disc cannot be played due to scratches, etc.	Replace with a non-scratched, non-warped disc.
ERROR 6	A disc is loaded upside-down inside the DVD deck and does not play.	Eject the disc then reload it properly.
PARENTAL VIOLATION	Parental level error	Set the correct Parental level.
WRONG REGION	Region code error	Eject the disc, and replace correct region code disc.
DRM	WMA files protected by DRM are played.	Perform the operation such as skipping a file. (Scan, repeat and random playback mode may be canceled.)
NOT SUPPORT	Files not supported by this unit are played.	

CD Changer

Display	Cause	Measure
ERROR 2	A disc inside the CD changer is not loaded.	This is a failure of CD changer's mechanism and consult your store of purchase.
ERROR 3	A disc inside the CD changer cannot be played due to scratches, etc.	Replace with a non-scratched, non-warped disc.
ERROR 6	A disc inside the CD changer cannot be played because it is loaded upside-down.	Eject the disc then reload it properly.

If an error display other than the ones described above appears, press the Reset button. If the problem persists, turn off the power and consult your store of purchase.

* When the Reset button is pressed, frequencies of radio stations, titles, etc. stored in memory are cleared.

10. SPECIFICATIONS

FM Tuner

Frequency Range: 87.9 MHz to 107.9 MHz
 Usable Sensitivity: 9 dBf
 50dB Quieting Sensitivity: 15 dBf
 Alternate Channel Selectivity: 70 dB
 Stereo Separation (1 kHz): 32 dB
 Frequency Response (± 3 dB): 30 Hz to 15 kHz

AM Tuner

Frequency Range: 530 kHz to 1710 kHz
 Usable Sensitivity: 28 dB μ V

DVD Player

System:
 Digital Versatile Disc System with CDDA capable
 Usable discs:
 DVD video disc, Compact disc
 Frequency Response:
 20 Hz to 20 kHz (CD) (± 1 dB)
 Dynamic Range: 100 dB (1 kHz)
 Distortion: 0.006%

Audio Amplifier

Maximum power output:
 200 W (50 W \times 4)
 Speaker impedance: 4 Ω (4 to 8 Ω allowable)

Input

Audio input:
 130 \pm 60mVrms (High)
 600 \pm 80mVrms (Mid)
 840 \pm 100mVrms (Low)
 (input impedance 10 k Ω or greater)
 Video input:
 1.0 \pm 0.2 Vp-p (input impedance 75 Ω)

Video Output

Video output:
 1.0 \pm 0.2 Vp-p (output impedance 75 Ω)

LCD Monitor

Screen Size: 7-inch wide type
 156.2 mm Width \times 82.3 mm Height
 Display method:
 Transmission type TN liquid crystal display
 Drive method: TFT (thin-film transistor)
 active matrix driving
 Pixels: 336,960 (480 \times 3 (RGB) \times 234)

General

Power source voltage:
 14.4 V DC (10.8 to 15.6 V allowable)
 Ground: Negative
 Current consumption: 4.0 A (1 W)
 Auto Antenna Rated Current: 500 mA less
 Dimensions of the Main Unit:
 7" Width (178 mm) \times 3-15/16" Height
 (100 mm) \times 6-5/16" Depth (160 mm)
 Weight of the Main Unit: 2.6 kg
 Dimensions of the Remote Control Unit:
 2-1/8" Width (54 mm) \times 1-1/8" Height
 (28.8 mm) \times 6-1/8" Depth (155 mm)
 Weight of the Remote Control Unit:
 100 g (including battery)

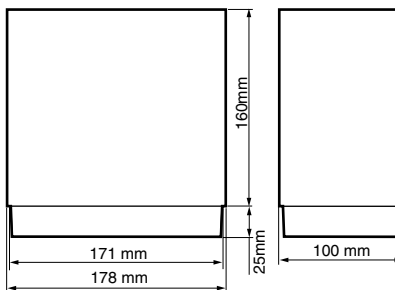

Note:

- Specifications comply with JEITA Standards.
- Specifications and design are subject to change without notice for further improvement.

Power Output:

19 W RMS \times 4 Channels at 4 Ω
 and 1% THD+N

Signal to Noise Ratio:

70 dBA (reference: 1 W into 4 Ω)



INSTALLATION AND WIRE CONNECTION MANUAL

■ Contents

1. BEFORE STARTING.....	67
2. PACKAGE CONTENTS.....	67
3. GENERAL CAUTIONS.....	67
4. CAUTIONS ON INSTALLATION.....	68
5. INSTALLING THE MAIN UNIT.....	69
6. CAUTIONS ON WIRING.....	71
7. WIRE CONNECTION.....	72
8. SAMPLE SYSTEM.....	75

1. BEFORE STARTING

1. This set is exclusively for use in cars with a negative ground 12 V power supply.
2. Read these instructions carefully.
3. Be sure to disconnect the battery “⊖” terminal before starting. This is to prevent short circuits during installation. (Figure 1)

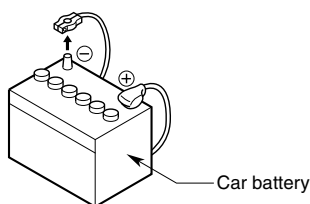

Figure 1

2. PACKAGE CONTENTS

- | | |
|--------------------------------------|-------------------------------|
| ① Main unit | ⑥ Bag for accessories (No. 2) |
| ② Manuals | Rubber cap (for RCA pin cord) |
| Owner's manual & Installation manual | ⑦ Remote control unit |
| Warranty card | ⑧ Battery |
| ③ Power supply cord | (for remote control unit) |
| ④ Rca pin cord | ⑨ Finisher |
| ⑤ Bag for accessories (No. 1) | |
| Flat head screw (M5 × 8)..... 8 | |
| Sems hexagonal bolt (M5 × 8)..... 8 | |
| Electro tap | |

3. GENERAL CAUTIONS

1. Do not open the case. There are no user-serviceable parts inside. If you drop anything into the unit during installation, consult your dealer or an authorized Clarion service center.
2. Use a soft, dry cloth to clean the case. Never use a rough cloth, thinner, benzine, or alcohol, etc. For tough dirt, apply a little cold or warm water to a soft cloth and wipe off the dirt gently.

4. CAUTIONS ON INSTALLATION

1. Prepare all articles necessary for installing the main unit before starting.
2. This model features an operation panel that slides forward. On some types of cars, the operation panel may make contact with the dashboard or gearshift lever, in which case it cannot be installed. Before installing, check that the unit will not hamper operation of the gearshift lever or obstruct your view before selecting the installation location. (Figure 2)

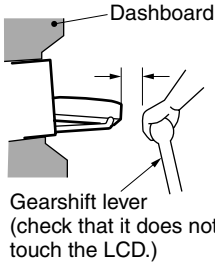

Figure 2

3. Install the unit within 30° of the horizontal plane. (Figure 3)

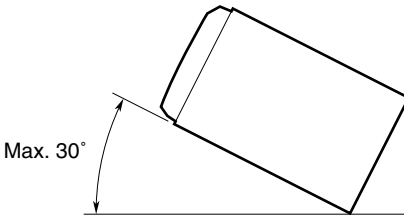

Figure 3

4. If you have to do any modification on the car body, such as drilling holes, consult your car dealer beforehand.

5. Use the included screws for installation. Using other screws can cause damage. (Figure 4)

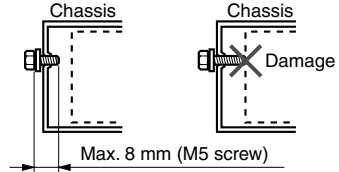

Figure 4

6. This unit has a fan motor in the back of the main unit so as not to raise the temperature in the main unit. When the fan motor vent is covered with cords or mounting bracket, it may cause a malfunction. Be sure not to cover it when wiring cords. (Figure 5)

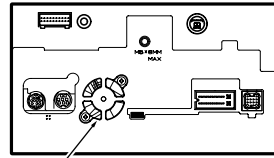

Figure 5

5. INSTALLING THE MAIN UNIT

This unit is designed for fixed installation in the dashboard.

1. When installing the main unit in NISSAN vehicles, use the parts attached to the unit and follow the instructions in Figure 6. When installing the main unit in TOYOTA vehicles, use the parts attached to the vehicle and follow the instructions in Figure 7.

2. Wire as shown in Section 7 (see page 72).
3. Reassemble and secure the unit in the dashboard and set the face panel and center panel.

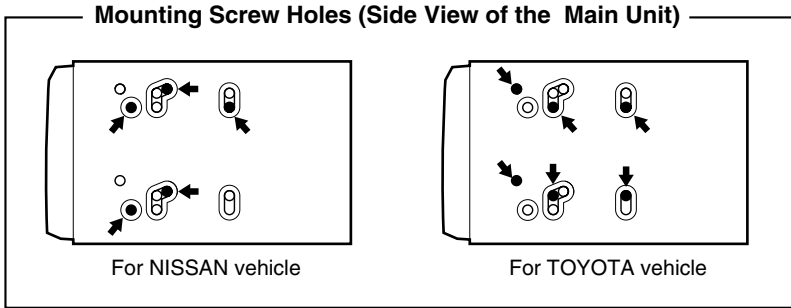

Installing the Main Unit in a NISSAN Vehicle

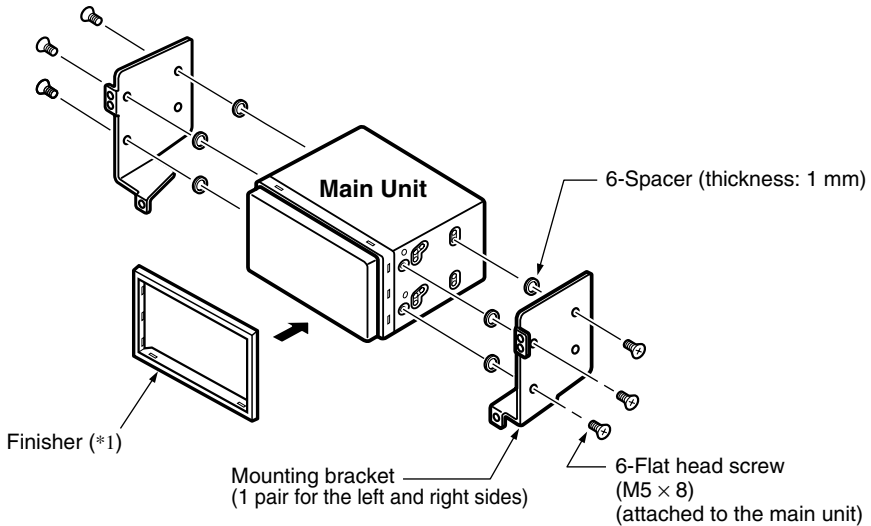

Figure 6

Note:

- *1: Position the face panel with its wide edge at the bottom. Fit the edge into the groove of the main unit.

Installing the Main Unit in a TOYOTA Vehicle

Install by using parts attached to the vehicle. (Screws marked ★ are attached to the vehicle.)

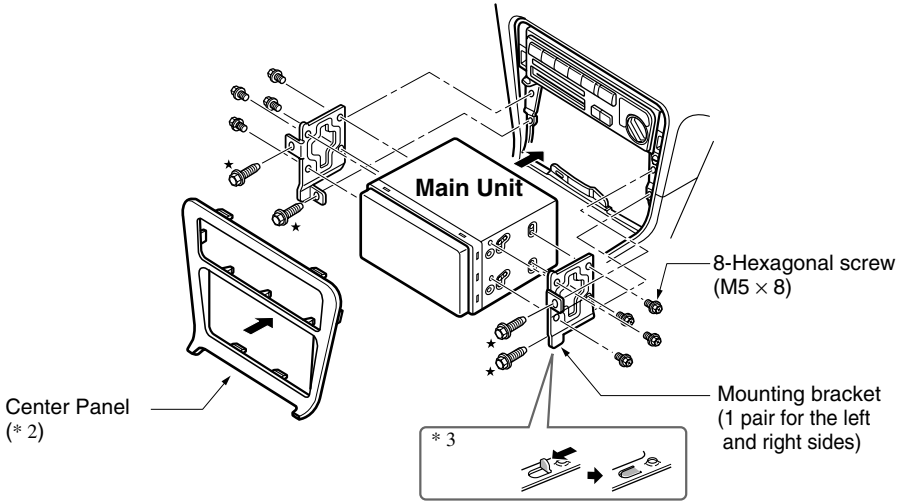

Figure 7

Note:

*2: Some panel openings are too small for the unit depending on the vehicle type and model. In such a case, trim the upper and lower sides of the panel frame by about 0.5 to 1.5 mm so the unit can be inserted smoothly.

*3: If a hook on the installation bracket interferes with the unit, bend and flatten it with a nipper or similar tool.

Typical Mounting Brackets

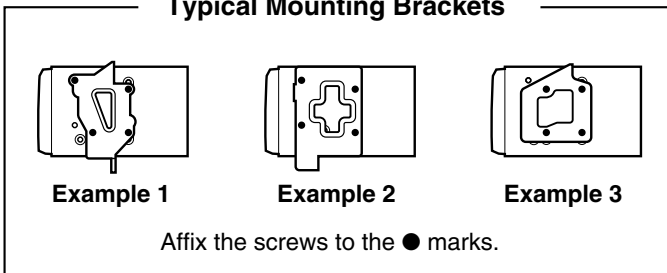

Vehicles other than NISSAN and TOYOTA

In some cases the center panel may require modification. (Trimming, filing, etc.)

● Removing the Main Unit

When the main unit is to be removed, disassemble it in the reverse of the order in "INSTALLING THE MAIN UNIT" (see page 69).

6. CAUTIONS ON WIRING

1. Be sure to turn the power off before wiring.
2. Be particularly careful where you route the wires.
Keep them well away from the engine, and exhaust pipe, etc. Heat may damage the wires.
3. If the fuse should blow, check to see if the wiring is correct.
If a fuse is blown, replace it with a new one of the same amperage rating as the original (15A FUSE).
4. To replace the fuse, remove the old fuse of the power supply cord and insert the new one. (Figure 8)

Note:

- There are various types of fuse holder. Do not let the battery side touch other metal parts.

⚠ CAUTION

After the connection, fix the cord by a clamp or insulation tape for protection.

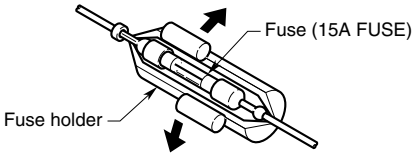

Figure 8

5. Connect the CeNET extension cable fully and securely until it locks. When the CeNET extension cable is pulled, hold the slide cap part and pull it towards you. (Figure 9)
* When the CeNET extension cable is extended or branches, use extension cable CCA-520 (2.5 m) or CCA-521 (0.6 m), or Y-adaptor CCA-519 (each of them is sold separately).

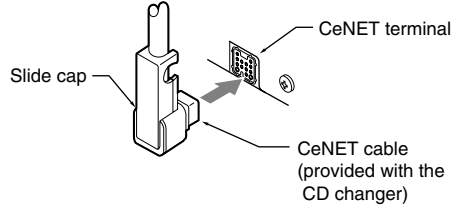
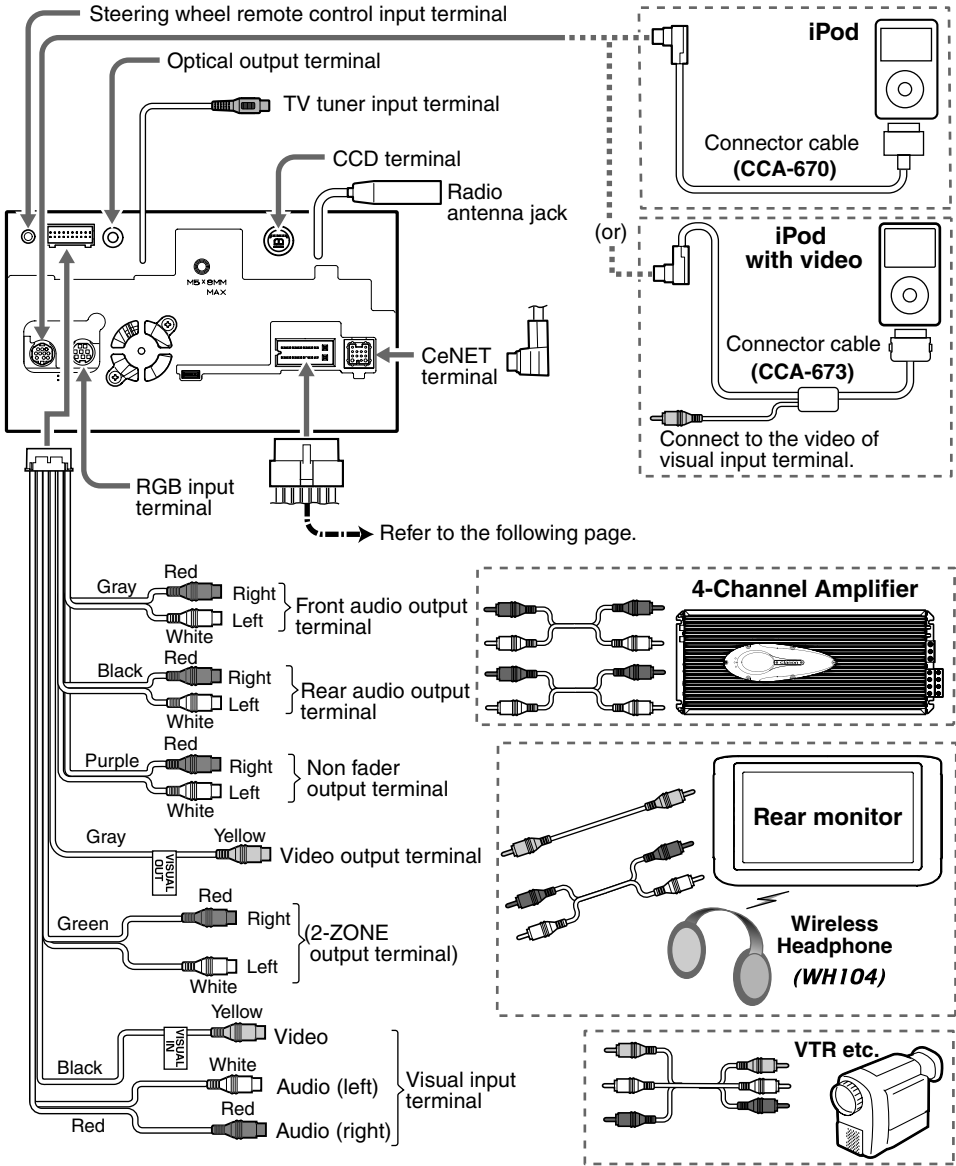

Figure 9

7. WIRE CONNECTION

Note:

- Before installing, be sure to disconnect the negative ⊖ cable of the car battery.
- In the optional devices, the RCA Pin and the Connector cable are separately-sold items.

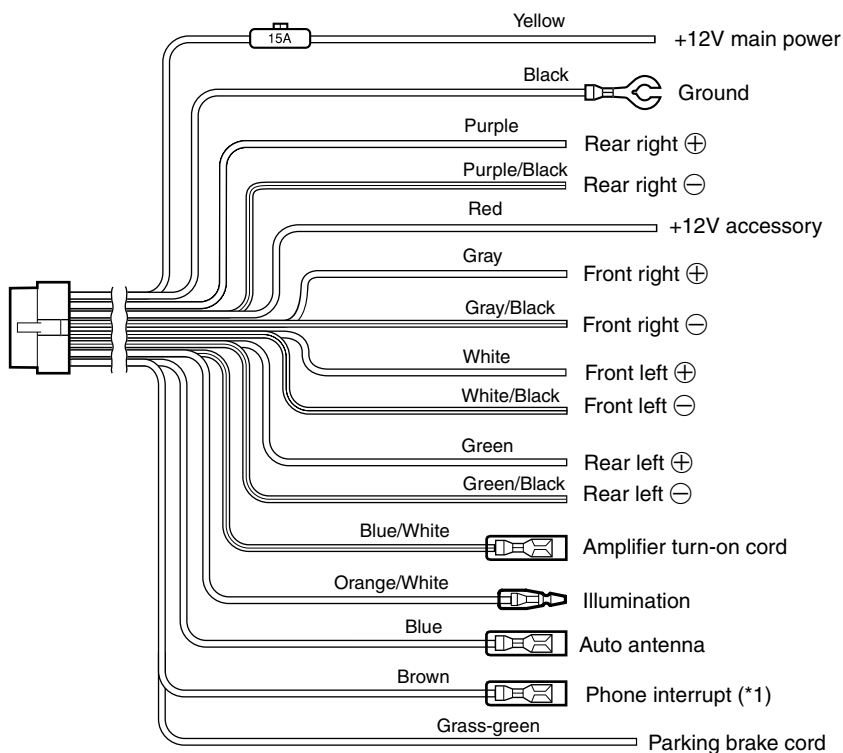

**Note:**

*1: Connecting the PHONE INTERRUPT terminal

The cord included with the unit must be connected to the specified position of the vehicle's connector in order to use the **"Cellular phone interrupt setting"** function (see page 26).

See next page for how to connect the parking brake cord.

● Connecting the parking brake cord

Connect the cord to parking brake lamp ground in the meter panel.

Note:

- Connecting the parking brake cord to lamp ground allows you to watch TV/VTR/DVD video/video CD when the parking brake is engaged.
- When the parking brake cord is not connected, the monitor will not turn on.
- If "AUDIO ONLY" appears on the screen just after turning on the ACC power of the car, release the parking brake while confirming safety, and then engage the parking brake again.

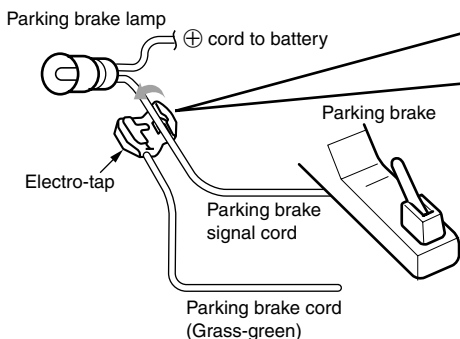

● How to attach the electro-tap

1. Place the Parking brake cord at the stopper, and fold it back in the direction of the arrow.
2. Pass the Parking brake signal cord through, and fold it back in the direction of the arrow.

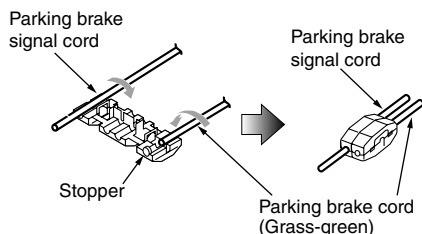

Connecting the Accessories

● Connection to the external amplifier

The external amplifier can be connected unless the 5.1 ch Surround Decoder is connected. For detailed information, refer to the instruction manual of the 5.1 ch Surround Decoder.

● Connection to the CCD camera for vehicle

The CCD camera for vehicle can be connected to CCD terminal on the main unit. For detailed information, refer to the instruction sheet or manual for the CCD camera.

Note:

- A power supply box (sold separately) is required for connection of the main unit and the CCD camera.
- The power supply box for the camera CAA147 cannot be used. Please use the CAA188 instead.

● If the specified cord of the cellular phone is connected to the phone interrupt cord of the main unit, the audio mute is available when the cellular phone is used.

● Satellite Radio Receiver

When a Satellite Radio Receiver is to be connected, use the CeNET connector. For detailed information, refer to the instruction manual of the Satellite Radio Receiver.

● TV Tuner

When the TV tuner is to be connected, connect the CeNET connector and RCA PIN (yellow). For detailed information, refer to the instruction manual of the TV tuner.

● Navigation System (NAX970HD)

When the Navigation System is to be connected, connect the CeNET connector and the RGB terminal. For detailed information, refer to the instruction manual of the Navigation System.

8. SAMPLE SYSTEM

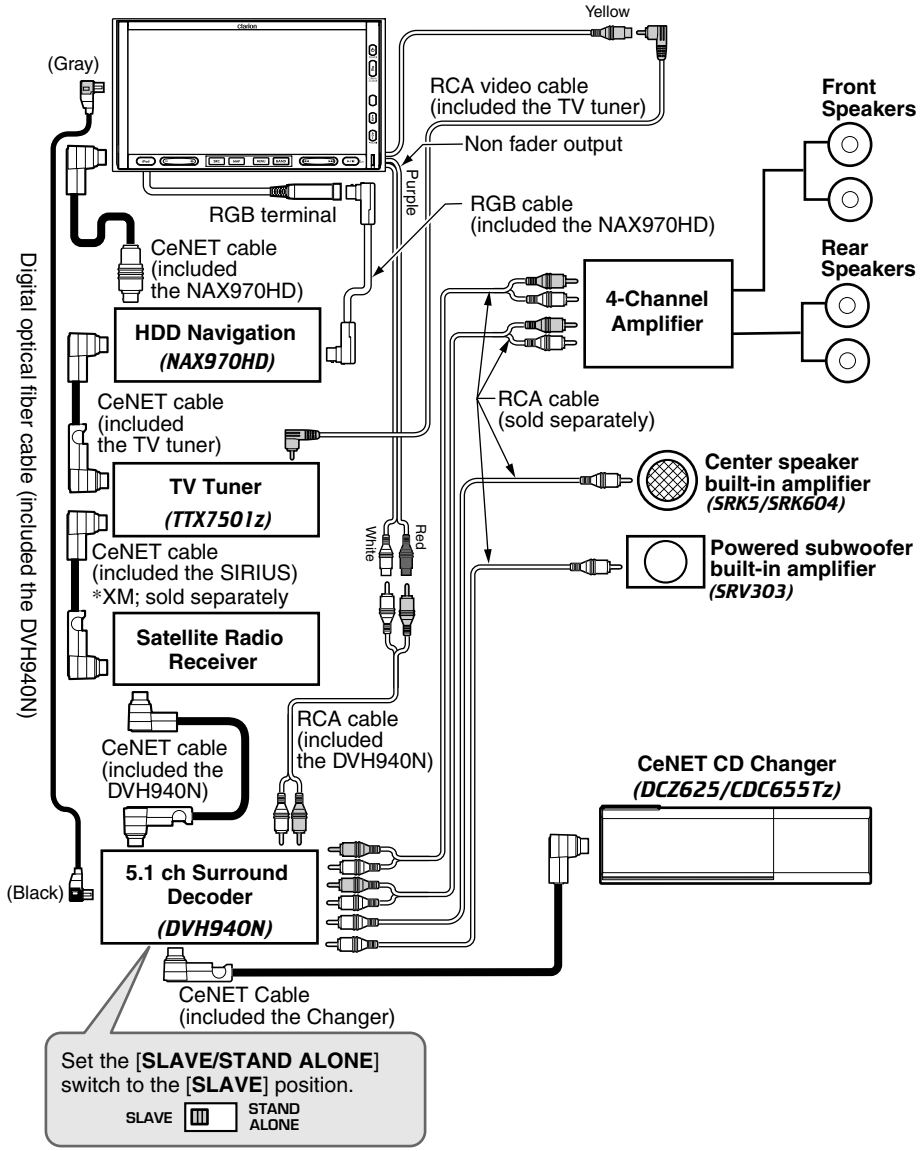

Clarion Co., Ltd.

All Rights Reserved. Copyright © 2007: Clarion Co., Ltd.
Printed in japan / Imprimé au Japon / Impreso en Japón

2007/3 (Y-Y1)

QZ-6070B
280-8510-00